

ŠTUDIJNÉ ZVESTI

ARCHEOLOGICKÉHO ÚSTAVU SLOVENSKEJ AKADEMIE VIED

41

SPECIAL THEME

ARCHAEOLOGICAL PROSPECTION



NITRA



ARCHEOLOGICKÉHO ÚSTAVU
SLOVENSKEJ AKADÉMIE VIED

41

**Publikácia vznikla v rámci Centra excelentnosti SAV
Výskumné centrum najstarších dejín Podunajska
pri Archeologickom ústave SAV v Nitre
Zmluva č. III/1/2005**

Študijné zvesti Archeologického ústavu SAV

41 - 2007

Hlavný redaktor / Editor-in-chief
Ivan Kuzma

Redakčná rada / Editorial board
Jozef Bujna, Eva Fottová, Ivan Cheben, Ján Rajtár, Jozef Zábajník

Počítačové spracovanie / Computer processing
Zuzana Turzová

Grafický návrh a počítačové spracovanie obálky / Graphic layout and computer processing of the cover
Ivan Kuzma

Predná strana obálky Golianovo, trojitý rondel lengyelskej kultúry.
Front cover Golianovo, tripple circular enclosure of the Lengyel culture.

Zadná strana obálky Golianovo, 3D model z magnetickej mapy.
Back cover Golianovo, 3D model from magnetic map.

© Archeologický ústav SAV Nitra 2007
Vychádza dva razy do roka / Issued twice a year

Kontaktná adresa (príspevky, ďalšie informácie) / Contact address (Contributions, Further informations)
Archeologický ústav SAV, Akademická 2, SK-949 21 Nitra, Slovakia
Tel: +421 37 7335738, Fax: +421 37 7335618, e-mail: ivan.kuzma@savba.sk

Rozširuje, objednávky a predplatné prijíma / Distributing, booking and subscription receives
Archeologický ústav SAV, Akademická 2, SK-949 21 Nitra
e-mail: nrauhalm@savba.sk

Za znenie a obsah príspevkov zodpovedajú autori.
The authors are responsible for their contributions.

Žiadna časť tejto publikácie nesmie byť reprodukováaná, alebo rozširovaná v žiadnej forme - elektronicky či mechanicky, vrátane fotokópií, nahrávania, alebo iným použitím informačného systému, vrátane webových stránok, bez predbežného písomného súhlasu vlastníka vydavateľských práv.

No part of this publication may be reproduced or transmitted in any form - electronic or mechanical, including photocopy, recording, or any information storage and retrieval system, including web pages, without the prior written permission from the copyright owner.

ISSN 0560-2793
ISBN 978-80-89315-00-0

Tlač MICHEL ANGELO Nitra / Printed by MICHEL ANGELO Nitra

OBSAH - INHALT

Editorial	7
In Honour of Otto Braasch	9
Ivan Kuzma Aerial Archaeology in Slovakia.....	11
Ján Tirpák Geophysical Prospecting in the Slovak Archaeology.....	40
Elena Blažová The Quality of DTM with Respect to the Used Software and Definition of Input Data.....	55
Joachim Henning - Matej Ruttkay - Eyub Eyub - Peter Bednár - Eva Fotová - Peter Milo - Jan Tirpák - Monika Kopčková - Klaudia Daňová Archaeological Research and Geophysical Exploration at the Early Medieval Fortified Settlement in Majcichov and Other Sites.....	56
Joachim Henning - Eyub Eyub - Matej Ruttkay Geomagnetic Prospecting of the Hill-fort of Pobedim (Slovakia).....	58
Ivan Kuzma - Tibor Lieskovský Analysis of Roundel Visibility in GIS Environment	60
Ján Tirpák - Eva Fotová - Martin Bartík Geophysical Prospecting of Deserted Village Dolný Poltár.....	65
Ján Tirpák - Ján Rajtár - Alexander Matei - Florin Scurtu - Vladimír Varsik Geophysical Prospection Porolissum, Romania	67
Peter Barta - Martin Bartík - Lucia Benediková - Jozef Ďuriš - Karol Pieta - Shehab A. H. Shehab - Svorad Štolc - Ján Tirpák Geophysical Prospecting of the Bronze Age Site Al-Khidr, Failaka Island, State of Kuwait	69
Karol Pieta - Shehab A. H. Shehab - Ján Tirpák - Mario Bielich - Martin Bartík - Jozef Ďuriš Archaeological and Geophysical Prospecting of Deserted Early Islamic Village Al-Qusur (Failaka Island, State of Kuwait)	74
7th INTERNATIONAL CONFERENCE ON ARCHAEOLOGICAL PROSPECTION	
Topics of the 7th International Conference on Archaeological Prospection	78
Otto Braasch Gallipoli ahead - Air Survey between the Baltic and Mediterranean	84
Takayuki Ako - Hiroyuki Kamei Circular Archaeological Survey Based on the GIS at the Sikiryu-site, Kagoshima, Japan.....	97
Babak Aminpour Comparison of the Magnetic Survey and Excavation Results in Rescue Archaeological Project of Tang-e Bolaghi (Iran).....	99
Pier Matteo Barone - Elena Pettinelli - Elisabetta Mattei - Alberto De Santis - Elisabetta De Minicis GPR Investigations in the Archaeological Area of Ferento (Viterbo, Lazio, Italy)	101
Helmut Becker - Stefano Campana - Thomas Himmler - Iacopo Nicolosi Fluxgate, Overhouser and Caesium-Magnetometry for Archaeological Prospection at Roselle-Aiali (Italy).....	103
Andrey Belinskiy Usage of "Corona" Satellite Images in the Creation of a Geo Information System (GIS) "Archaeological sites of the Stavropol Region"	107
Christophe Benech Study of Ancient City Planning with Axial Maps and Visibility Graph Analysis.....	109
Meriç A. Berge - Mahmut G. Drahor Electrical Resistivity Inversion Modelling Studies for Commonly Used Arrays in Höyük (Artificial Hill) Type of Archaeological Settlements.....	112

Miron Bogacki - Wiesław Małkowski - Tomasz Mikocki - Krzysztof Misiewicz - Monika Muszyńska Multimethodological Approach to the Study of Ancient City Planning: the Case of Ptolemais in Cyrenaica, Libya.....	116
Ksenija Bondar - Ivan Virshylo Archaeological Interpretation of Magnetometric Data Using 3D Magnetic Modeling Examples from Ukraine.....	117
James Bonsall - Heather Gimson - Kevin Barton The Role of Integrated Archaeological Geophysical Surveys in Development-led Housing and Road and Community Projects in Ireland	121
Stefano Campana - Salvatore Piro - Cristina Felici Integration between Different Remote-sensing Surveys to Characterise Aiali Archaeological Site (Grosseto, Central Italy).....	122
Giuseppe Ceraudo - Laura Castrianni Giacomo Boni: a Pioneer of the Archaeological Air Photograph	125
Francesca Colosi - Gabriele Fangi - Roberto Gabrielli - Roberto Orazi - Daniela Peloso Satellite Images and GIS for the Archaeological Park of Chan Chan	126
Michel Dabas - X. Cassassolles - M. Chemin - L. Conte - A. Favard - J. M. Valet - F. X. Simon Integration of ARP and AMP for Rescue Archaeology: Example of a 50 ha Project	129
Mirosława Dernoga - Tomasz Herbich - Ryszard Pietrzak - Włodzimierz Rączkowski - Dawid Świąch Discovering Medieval Szamotuły (Wielkopolska region): a Multidisciplinary Approach	131
Donatella Dominici - Filippo Del Guzzo The Use of Remote Sensing in Archeology: the Example of Capestrano Project.....	134
Aleksey Dvlgalev Geoinformational Monitoring of Archaeological Monuments in the Stavropol Region.....	136
Mahmut G. Drahor - Özgür T. Kurtulmuş - Meriç A. Berge - Martin Hartmann - Michael A. Speidel Large-Scale Magnetic Imaging and Electrical Resistivity Tomography Studies in a Roman Military Installation Area in Zeugma Archaeological Site, Southeastern Turkey.....	139
Petr Dresler - Peter Milo - Vojtech Šešulka Magnetic Prospection of the Rampart of the Early Mediaval Hill-fort Pohansko by Břeclav, Czech Republic	142
Olga Druzhinina - Ivan Skhodnov Using Methods of Palaeogeography in Field Archaeological Prospecting.....	144
Lev V. Eppelbaum Localization of Ring Structures in Earth Environments.....	145
Jorg W. E. Fassbinder - Karin Berghausen - Burkhard Vogt - Johannes Moser Easter Island (Chile): Magnetometry of Archaeological Structures On Basaltic Geology.....	148
Jörg W. E. Fassbinder - Dmitry Korobov - Sabine Reinhold - Andrej Belinskiy - Sergej Merkulov Magnetometry on Newly Discovered Bronze Age Settlements in the North Caucasus (Russia)	151
Irene Forstner-Müller - Tomasz Herbich - Christian Schweitzer Surveying Ancient Cities in the Nile Delta: the Tell el-Dabca Case.....	154
Domenico Fossataro Geophysics and Geo-electrical Investigations Integrating the GIS of Iuvanum Survey Project.....	157
Alin Frînculeasa - Mădălina Frînculeasa Photogrammetry and Remote Sensing in Archaeology. Benefits and Limits.....	160
Mădălina Frînculeasa - Alin Frînculeasa Applications to Landsat Thematic Mapper Imagery in Geosciences Research (Special View to Geology and Archaeology).....	160
Chris Gaffney - Vince Gaffney - Richard Cuttler - Helen Goodchild - Susan Kane - Gareth Sears Magnetometer Survey at the Roman Town of Cyrene, Libya.....	161

Vojtech Gajdoš - Miroslav Hajach - Roman Pašteka - Kamil Rozimant High Resolution Magnetometry and Resistivity Imaging in Archaeological Prospecting - Case Studies from the Territory of Slovakia	162
Danilo Gallo - Marcello Ciminale - Helmut Becker Highly Integrated Non-destructive Investigation for the Reconstruction of Ancient Sites	166
Gennady Garbuzov - Irina Viktorovna Tolochko The Greek Colony Tanais Case Study: Integrated Prospection Approaches.....	168
Thomas Goldmann - Ronny Wutzler - Beate Mekiffer - Pawel Wolf - Mohamed Abdelwahab Mohamed Ali Geomagnetic Survey at the Meroitic Settlement Hamadab, Sudan.....	170
Sébastien Gondet Multi-scaled Approaches of a Renewed Survey Program into the Plain of Persepolis (Central Fars, Iran). Did Everyone Live in Palaces During Achaemenid Times?.....	172
Sébastien Gondet - Christophe Benech Understanding of the Succession of Geomagnetic Anomalies Due to a Complex Defence System: the Case of Al-Rawda (Syria).....	174
Tomasz Gorka - Jörg W. E. Fassbinder - Karsten Lambers Magnetometry on the Geoglyphs of Palpa and Nasca (Peru).....	176
Bryan S. Haley - Jay K. Johnson Mapping the Chickasaw with Integrated Magnetic Geophysics	179
Vladimír Hašek - Jaromír Kovárník - Jaroslav Peška The Present State of Non-destructive Archaeological Surveying in Moravia	182
Ian Haynes - Vince Gaffney - Michael Lobb - Margaret Watters - Steve Wilkes - Salvatore Piro - D. Zamuner High-resolution Integrated Surveys in the Archaeological Site of St. John Lateran Basilica (Roma, Italy).....	185
Tomasz Herbich Geophysical Surveying in Egypt: Periodic Report for 2005-2006.....	188
Milan Hornák - Susanne Stegmann-Rajtár Late Bronze Age Settlement in the Middle Nitra Region: Applicability of GIS Analyses	191
Guillaume Hulin - Michel Dabas - Alain Tabbagh - Jeanne Tabbagh - Julien Thiesson Feasibility of a Towed EM and Magnetic Device for Archaeological Prospecting	192
Sergey K. Izyumov - S. Mironov - Vojtech Gajdoš Application of Georadar Method for Engineering and Geological Surveying of Historical Places	194
Akihiro Kaneda - Yasushi Nishimura - Yoshiaki Miyake - Jyunichi Shimoda - Hisao Nezu Geophysical Survey at Tokushima Castle in Japan	196
K. Kogawa - H. Kamei - M. Honda - S. Nagase - D. Kamimura - K. Shinba Integrated Geophysical Survey around Mt. Kaimondake, Japan - To Search an Original Location of Hirakiki Shrine	197
Dmitry S. Korobov Early Medieval Settlements in the Kislovodsk Basin (South of Russia): GIS, Aerial Photography and Geophysics.....	200
Roman Křivánek Possibilities and Limitations of Surveys by Caesium Magnetometers in Forested Terrains of Archaeological Sites.....	202
Roman Křivánek - Miloš Čížmář The Combination of Magnetometric Prospection and Other Non-destructive Survey Methods of a Large La Tène Site Near Némčice, Central Moravia. Present Results and Future Possibilities	205
Rosa Lasaponara - Antonio Lanorte - Rosa Coluzzi - Nicola Masini On the Use of Satellite Imagery in Archaeological Context: a Comprehensive Review.....	208
Jürg Leckebusch - Andreas Weibel - Flurin Bühler Computer-assisted GPR Data Interpretation	208

Jürg Leckebusch - Hans Sütterlin Large Scale GPR Surveys in Augst	210
Neil Linford - Paul Linford - Louise Martin - Andrew Payne Geophysical Evidence for Assessing Plough Damage.....	212
Nicola Masini - Rosa Coluzzi - Antonio Lanorte - Rosa Lasaponara Performance Evaluation of Edge Detection Algorithms for the Detection of Archaeological Features by Using Satellite Data	214
Oliva Menozzi GIS Project of the Cyrenaican Valleys (Libya).....	215
Pasquale Merola Roman Centurie Reconstructed by Hyperspectral Remote Sensing	217
Alexandre Novo - Henrique Lorenzo - Fernando I. Rial - Manuel Pereira - Mercedes Solla - Pedro Arias From Searching to 3D Imaging: GPR Ultra-dense Grid Methodologies	219
Roman Pašteka - Miroslav Terray - Miroslav Hajach - Mariana Pašiaková Microgravity Measurements and GPR Technique in the Search for Medieval Crypts: a Case Study from St. Nicholas Church in Trnava, SW Slovakia	222
Salvatore Piro Application of GPR Investigations in the Urban Area of Forum (Roma, Italy)	224
Salvatore Piro - Roberto Gabrielli - Daniela Peloso Integrated Surveys to Locate Chamber Tombs in the Sabine Necropolis (Rome - Italy).....	226
Artur Poreba Electromagnetic, GPR and Resistivity Imaging Measurements for Studying the Loess Archaeological Site of Karmanowice (Poland)	229
Valeria Poscetti Georadar and Electrical Tomography Surveys Compared to an Old Archaeological Map (Necropolis of "Casale del Fosso" - Veio, Italy).....	230
Martin Posselt Geophysics and Excavation - Layers of Archaeological Feedback	233
Roger Sala - Maria Lafuente Visualising the Ibero-Roman Site of Puig-Ciutat (Catalonia, Spain) from Magnetic Variation Maps and GPR Time-Slices.....	234
Armin Schmidt - Robin Coningham Geophysical Prospection for Archaeological Investigations in South Asia	238
Volkmar Schultze - Sven Linzen - Tim Schüler - Ronny Stolz - Andreas Chwala - Marco Schulz - Hans-Georg Meyer Large-scale, Fast and Sensitive Geomagnetic Archaeometry Using a SQUID-based Measurement System	240
Julien Thiesson - Alain Tabbagh - Michel Dabas What Are the Advantages of Several Magnetic Parameters Measurements in Prospection?	243
Galina V. Trebeleva Geoinformation System (GIS) of Archeological Sites of Northeast Black Sea Coast.....	244
Immo Trinks - Lars-Inge Larsson - Alois Eder-Hinterleitner Mapping of Sweden's First Town Birka Using Georadar and Magnetometer Prospection	245
Immo Trinks - Lars-Inge Larsson Geophysical Prospection and Archaeological Feedback in Rescue Archaeology - Examples from Sweden.....	247
Gregory N. Tsokas - Panagiotis I. Tsourlos Non-destructive ERT Survey at the South Wall of Acropolis of Athens	250
Panagiotis I. Tsourlos - Gregory N. Tsokas Archeological Prospection by Means of Fully Non-destructive DC Resistivity Surveying.....	252
Burkart Ullrich - Henning Zöllner - Sergey Makhortykh - Michail Orliuk - Renate Rolle Geophysical Prospection of the Scythian Fortification of Belsk (Boľšoe Belskoe Gorodišče).....	254
Jaromír Kovárník Aerial prospection in Moravia.....	256

EDITORIAL

When speaking about archaeology, everybody thinks of excavations. Only for past years, had general public chance to learn about how can be the archaeological knowledge obtained without disturbing a terrain. It is thanks to non-destructive archaeology applying methods of prospection, aerial photography, geophysical or geochemical measurements and other techniques like surface surveys, mapping of anthropogenic relief shapes, application of GIS methods and many more.

The impact of these methods on archaeology is permanently growing because of their relatively low price, high effectiveness and potential for studying whole sites or even regions. Therefore, non-destructive approach is crucial for the research on settlement and landscape archaeology, but also for planning archaeological excavations and archaeological heritage management.

An importance of prospection has been growing in present archaeology. It is possible to observe it in the case of building boom, where prospection methods can influence planning of terrain disturbance, i.e. directing excavations most effectively. In the future, archaeological prospection as a group of non-destructive methods should become a primary source of information. Archaeological research could only supplement the results if necessary, i.e. beyond reach of archaeological prospection.

The complete 41st volume of Študijné zvesti Archeologického ústavu SAV is dedicated to the 7th Conference on Archaeological Prospection, planned for September 11-15, 2007, in Nitra, Slovakia. It is organized by the Archaeological Institute of Slovak Academy of Sciences and the International Society for Archaeological Prospection.

The volume contains abstracts of 83 papers presented at the conference.

The first part of the volume includes articles presenting results achieved by members of the Archaeological Institute of the Slovak Academy of Sciences. The opening articles briefly inform about Aerial Archaeology and Geophysical prospecting at Archaeological Institute of SAS and are followed by themes from Slovakia and abroad as well. In the end, there are presented some results of Kuwaiti-Slovak Archaeological Mission (KSAM), which has been designed as a joint Kuwaiti-Slovak multidisciplinary research project fostering international cooperation and ties between young-generation researchers. The major objective of KSAM is salvage excavation of Al-Khidr site on Failaka Island.

The second part of the volume contains invited paper of Otto Braasch and abstracts of papers presented at the conference in a form of concise articles, which briefly inform about latest knowledge, developments and results of archaeological prospection worldwide.

This volume was prepared by Ivan Kuzma, Zuzana Turzová, Tereza Belanová and Ján Tirpák. English texts of all papers are the responsibility solely of the individual contributors.

Ivan Kuzma
Editor-in-chief



Photo Klaus Leidorf

Older

In Honour of Otto Braasch

This volume, produced for the conference, is dedicated to an extraordinary man who was celebrating his seventy anniversary last year - Mr. Dr. H. c. Otto Braasch, which has had major impact on the development of aerial prospection in the whole Europe.

I think it is appropriate to say, Otto and archaeological/aerial prospection have been always somehow interconnected. Thanks to him, we obtained in this discipline new impulses and thus it is hard to imagine archaeological science without it. Results of aerial prospection have influenced the development of other prospection methods, notably geophysics, which confirmed new discoveries from the air.

Former lieutenant colonel and starfighterpilot of German air force Otto Braasch has been already for 30 years the main moving spirit behind the aerial prospection in Europe, which has been developed thanks to his work in a large extent. The beginnings of his aerial prospection go back to 70's in Bavaria and Baden-Württemberg. Otto flew after 1989, with great enthusiasm, over the areas of former German Democratic Republic and at that time on an untouched part of the country by aerial prospection, he made a lot of work.

Otto Braasch has initiated various projects, e.g. *"Treasures of our common past in Europe – history written in earth"* within EU RAPHAEL-Program. This project has proven his great sense of European cultural heritage. The travelling exhibition (in Prague, Dresden, Pécs, Bratislava, Nitra and Košice) has successfully mediated to public results of aerial archaeology from the Czech and Slovak Republics, Germany, Hungary and Great Britain.

Besides further methodological developments of the aerial prospection, it is worth to mention wide range of Otto's activities, which are aimed to educate young generation of aerial archaeologists. He was the main moving spirit behind the Culture 2000 project *„Conservation through Aerial Archaeology,"* which initiated periodic series of training schools and workshops in Poland, Great Britain, Italy, Germany and other countries. A notable increase of qualified archaeologists specialized on aerial prospection is the result of these activities.

Otto Braasch has published his results in numerous publications, among which unforgettable remain *Das Unterirdische Bayern* and *Unterirdisches Baden-Württemberg*.

For his activity, he was awarded several renowned prizes. In 1994 he was given *Deutsche Preis für Denkmalschutz* (German prize for Heritage preservation) and in 2001 European Association of Archaeologists awarded him with *European Archaeological Heritage Prize 2001*. In 1999 Otto Braasch was given by *Freie Universität Berlin* the honorary title of *Doctor honoris causa* for his contribution to aerial archaeology in Germany.

I could go on in enumerating of Otto's merited acts, but I think all his outstanding work will always speak for him.

Ad Multos Annos Otto
(and many more flying hours)

Ivan Kuzma

AERIAL ARCHAEOLOGY IN SLOVAKIA

Ivan Kuzma

Key words: Slovakia, aerial archaeology, historical overview, present state

A HISTORICAL OVERVIEW

Modern prospection methods of searching and mapping archaeological sites have recently been developing primarily in Western Europe. Almost all of the techniques were initially derived from methods used in geological-geophysical surveying and in topographic aerial photography. Today they are independent scientific disciplines. One of the most important and most effective primary methods of searching archaeological sites is aerial prospection, which at relatively low costs provides us with a lot of knowledge unattainable in other ways.

Aerial prospection and its systematic exploitation in archaeology in Slovakia are still in their beginnings compared to the countries where they have been used for several decades. Photographs taken before the Second World War are scarce. The only one from that period is what is also the first aerial photograph published from the territory of Slovakia. It shows the area of the Roman fort in Iža from 1936 (Mencl 1937, Fig. 1) and was taken by the Third Aerial Regiment (Fig. 1: 1). The photographing was not intended for archaeological purposes and thus an existing vertical topographic photograph was used. The next photograph was taken intentionally in 1940 (Fig. 1: 2); it is a oblique photograph of excavations in the area of the so-called "Roman station" in Stupava (Ondrouch 1940/41, Tab. I). There are unfortunately minimal sources from this period.

Nevertheless, aerial photography has a forty years' tradition at the Archaeological Institute of the Slovak Academy of Sciences (AÚ SAV) in Nitra, the first flights being initiated by the then director A. Točík in 1963. As in other countries, however, this use of prospection was intended for documentation of known sites and excavations. From this period we have several aerial views of e.g. the excavation in Nitriansky Hrádok, hillforts in Bíňa, Smolenice and Starý Tekov, the fortified settlement in Kamenín as well as burial mounds (tumuli) in Cabaj and Dvory nad Žitavou, and some other sites (Točík-Vladár 1971, 385, Fig. 16; Habovštiak 1971, 611, Fig. 7; Archive of AÚ SAV in Nitra). The first site in Slovakia discovered from the air - the Slavic hillfort in Majcichov - was also photographed during these flights. It continues to be photographed under various conditions (Fig. 2).

This period was followed by a longer break until a helicopter was used for aerial photo-documentation of the excavation of the Neolithic circular fortification in Svodín (Fig. 3) in 1977 (Němejcová-Pavúková 1978, Fig. 90).

The first actual reconnaissance flight intended for searching archaeological sites visually was thus the one in 1978 over the building area of the hydro-electric power plant system Gabčíkovo-Nagymaros on the Danube. Insufficient experience and short-term flight permits in bad conditions, partially without vegetation cover, brought about very modest results (Kolník 1987, 193). Further flights in the region of South-West Slovakia were realised from 1982.

To complete the enumeration of aerial activities at the Institute, photographing from a radio-operated model must be mentioned. It was carried out in 1974 and 1975 on the excavation of the so-called "Roman station" (Fig. 4) in

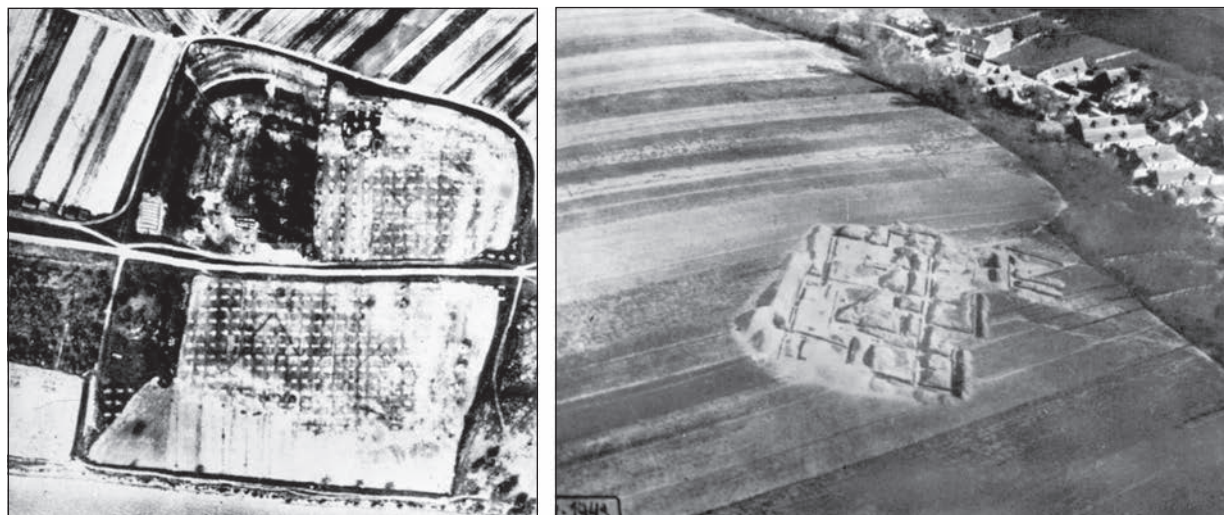

Fig. 1. 1 - Roman fort in Iža. Vertical photograph from 1936; 2 - Stupava. Oblique photograph of the excavation on the "Roman station" (Ondrouch 1940/41, Tab. I).



Fig. 2. Majcichov, Trnava district. Slavic hillfort 1 - 15 May 1967; 2 - 15 December 1988; 3 - 18 April 1996; 4 - 17 December 2003.



Fig. 3. Svodín. Lengyel culture roundel, 24 November 1977, photo J. Krátky.

a cooperation with the Geographic Institute of the Czechoslovak Academy of Sciences (ČSAV) in Brno (*Kolník 1987, 189, Abb. 1-3*). This method was taken up indirectly in 1987-88 as supplementary to the real prospection, for photographing excavations and detected sites such as roundels or Roman forts. The method gave at minimal costs vertical photographs in the required scale. Unfortunately, it ceased to be used after 1989.

Wider employment of aerial prospection in the previous regime was prevented by various restrictions. Therefore, at least topographic vertical photographs borrowed from the Military Topographic Institute and, less frequently, multispectral aerial photographs from the archive of the Geographic Institute of SAV were used. However, smaller anthropogenic features cannot be fully determined on these photographs, which are created in scales 1 : 6.000 to 1 : 25.000. On the other hand, they provide important information on the structure of land utilization and on the original natural environment of known sites, e.g. extinct and aggradated old water courses, meanders, river branches and river-beds. The vertical photographs are still used and larger features have been identified on them, e.g. roundels in Prašník, (*Kuzma 2002*), Hosfovcé, Chorvátsky Grob and others, of which some have later been verified by aerial survey.

PRESENT

At the Archeological Institute in Nitra we started systematic aerial prospection as late as in mid-1980s. Today we are still the only institution that deals with this activity.



Fig. 4. Cífer-Pác. Photograph from a radio-operated model, 1975.

soil conditions as well as intensive agricultural use of this region. Rich in archeological material are especially the regions of middle and lower Váh River basin, Nitra River basin, Žitava River basin, Hron River basin and Trnava upland, and Záhorie and Žitný ostrov regions. The regions of Middle and East Slovakia are covered by aerial prospection to a lesser degree.

We fly most in early spring when archaeological objects are manifest in vegetation, and less in late autumn and winter months when there is little or no vegetation.

Our experience so far has fully confirmed the advantages of this prospection method in the geomorphological, climatic and soil conditions of Slovakia. The results are a significant contribution to our knowledge of settlement and land development from prehistoric to medieval period. Of particular importance is the marked increase of archaeological sites discovered by aerial prospection, which supplies new information on the density and intensity of the settlement in several regions. Significant are also qualitatively new data connected with geographic enlargement, location and structure of some settlement types, fortifications and burial grounds. Particularly valuable and irreplaceable is information about the total range, character and state of preservation of archaeological sites, with regard to effective protection against possible danger or destruction.

Bratislava-Rusovce is a good example. In 1996, a burial ground of about 100 graves was discovered by aerial prospection (Fig. 5: 1). Thus we were able to document the necessity of archeological excavation, since construction of family houses was planned for 2002. The excavation took place in 2002-2003 (Fig. 5: 2) and over 160 graves from

For surveying we usually use a four-seat Cessna 172 or 182, in the past also Zlín 43 was used. Flight paths and site localisation are filed both in a 1 : 100 000 map and by GPS.

For photographing we used the most common photographic equipment. First it was Pentacon Six especially for black and white material of 6x6 format and Practica for colour diafilm. We used video camera supplementarily, especially for photographing wider circumstances and the surroundings of archeological sites. Gradually the quality of the equipment was improved and today digital technique dominates (Nikon D200 connected to GPS).

We have focused on the territory of West Slovakia so far, which was due not only to financial means and flying range but also to suitable geomorphological and



Fig. 5. Bratislava-Rusovce. 1 - burial ground before excavation, 8 June 2000; 2 - during the excavation, 17 May 2003.

the Migration Period were excavated (*Schmidtová/Weberová 2004*, 169). Without the results of aerial prospection this largest 6th century burial ground in Slovakia would be destroyed in construction works.

Aerial prospection should not be limited to mere photographing and mapping. A more complex procedure is desirable so that we do not talk merely of aerial prospection but of aerial archaeology, which has become a separate discipline. Its aim is surface surveying of the landscape from above, documentation of both hidden and visible parts of the cultural landscape, and their recording, interpretation and mapping. Aerial archaeology is an integration of partial processes (aerial prospection, field walking, verification surveying, geophysics, geochemical and pedological analyses and others) into one whole. Today it is considered an integral (and often decisive) part of landscape archaeo-

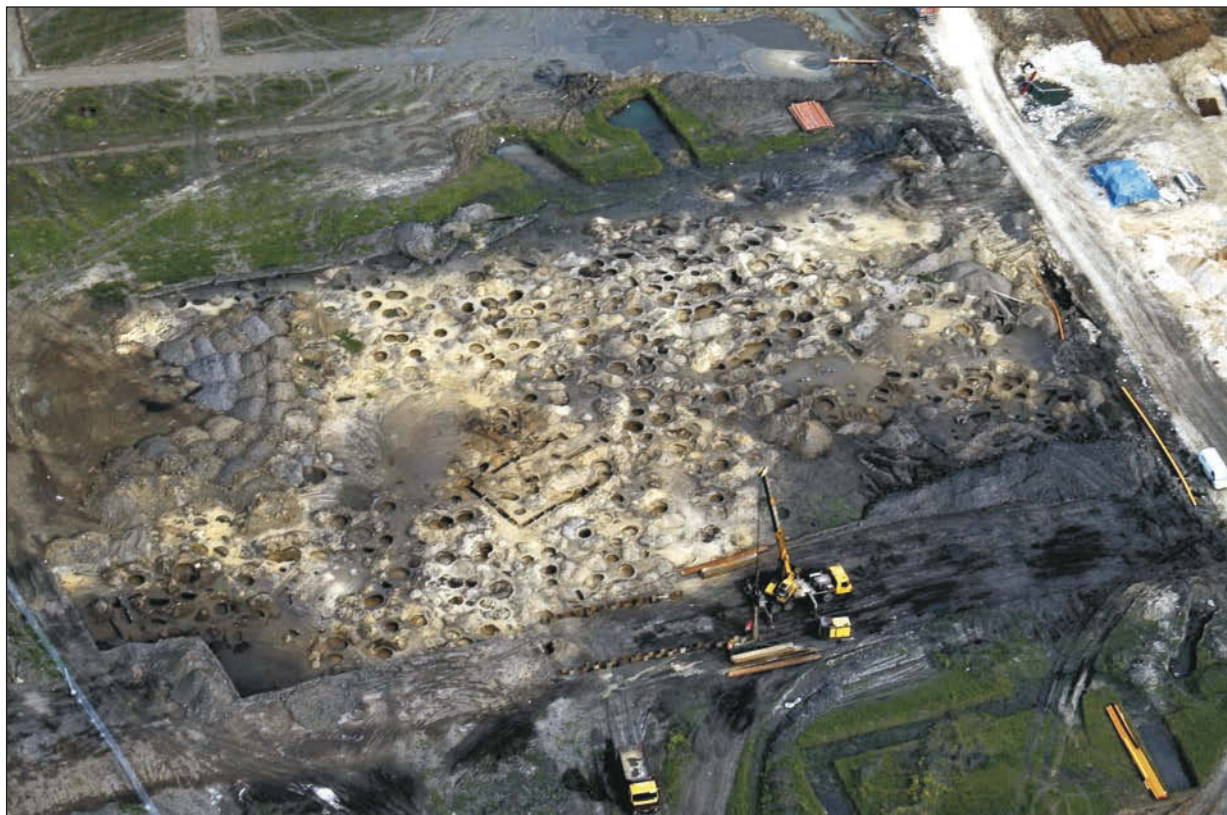

Fig. 6. Excavations on Sony construction site, Nitra, 17 May 2007.



Fig. 7. 1 - Skalica town centre with the original fortification;
2 - castle of Topoľčianky.

logy, which makes it possible, on the basis of analyses, to observe links between particular settlement units and their hinterlands, as well as their relations to the natural environment.

With typical objects and features we use mainly geophysical methods, which confirm the results of aerial prospection quickly and unambiguously. They are primarily used for verification of the existence of archaeological objects, and only secondarily for their cultural classification. The detected object does not necessarily need to be an anthropogenic feature, for in some cases it might be a geological phenomenon or a recent object. On the other hand, also with archaeological objects can the results of a geophysical measurement be surprising. As for the cultural classification, the circular enclosures are rarely accompanied by material indicating their dating. However, geophysical measurement revealed two to four ditches so that there is no doubt that the roundels date back to the Neolithic Period.

Geophysical survey is thus the first step in confirmation of the existence of archaeological objects, and in determining their exact position, size, range, orientation etc. These data allow for a more effective approach to excavations, which can in turn confirm the previous findings.

RESULTS

The number of newly found sites is currently around 800. The archive of the Archaeological Institute holds around 2500 oblique black-and-white 6x6 nega-

tives, more than 4000 slides and around 2000 vertical topographic photographs from several years. The number of photographs increases significantly after the transition to digital technique due to lower expenses.

The results are different in various regions of Slovakia but this does not always depend on the intensity of aerial prospection. The highest number of sites has been detected along Nitra and Žitava rivers, on predominantly light soil. Loess areas of Trnava upland and Hron River basin give more modest results although there was more or less continuous settlement (especially in case of the latter). The region of Žitný ostrov was a big empty place for a long time. Also documentation of sites in this area by traditional archaeological methods was only sporadic, due to complex hydrogeographic conditions. As a consequence of multiple alluvium especially the prehistoric sites lie as deep as 1,5 m under the current surface. Therefore there were doubts about the effectiveness of aerial prospection. The situation was similar north of Žitný ostrov, between Malý Dunaj and Čierna voda, Dudváh and Váh rivers. These regions lie in the zone of black soil, on alluvial loams with gravel background, where favourable conditions for aerial archaeology are difficult to obtain. Ideal conditions are particularly very dry years with bad crops.

The sites discovered so far range from single objects to settlements, burial grounds, fortifications of various types and dating, fortified settlements, circular enclosures, Roman temporary camps, traces of deserted villages and other features, which are often hard to interpret. Documenting the excavations (Fig. 6) as well as centres of towns and castles is a matter of fact (Fig. 7: 1, 2).

Wide-ranging presentation of our results would be impossible and therefore we will try to focus on particular exemplary cases from the more significant categories.

Circular features

It is not long time ago that density of circular ditch features was typical especially for the territory of Austria, and in a lesser degree for south Bavaria and south Moravia. Concentration of roundels in these areas was due to systematic aerial prospection. In the area of Lower Austria the large-scale aerial prospection developed from late 1970s and helped discover around 40 circular enclosures (*Friesinger/Nikitsch 1982*). In analogy, the number of circular fortifications in south-moravian region increases from 1983 when *J. Kovárník (1985)* and *M. Bálek (1985)* initiate systematic prospection. *G. Trnka (1991, 16)* mentions only roundels in Bučany and Svodín on the territory of Slovakia but he assumes the existence of others. This assumption is confirmed in late 1980s when aerial prospection becomes more intensive at the Archaeological Institute in Nitra. The results obtained recently by surveying and verification of

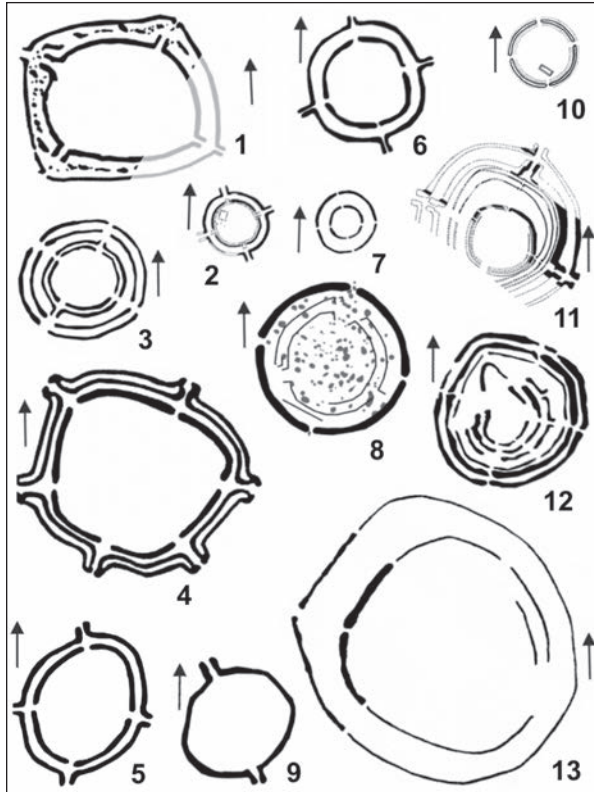

Fig. 8. Roundel typology in Slovakia: datable to the Neolithic period. 1 - Bajtava; 2 - Bučany; 3 - Cífer; 4 - Golianovo; 5 - Horné Otrokovce; 6 - Podhorany-Mechenice; 7 - Klačany; 8 - Prašník; 9 - Ružindol-Borová; 10 - Šurany-Nitriansky Hrádok; 11 - Svodín; 12 - Žitavce; 13 - Hostovce.

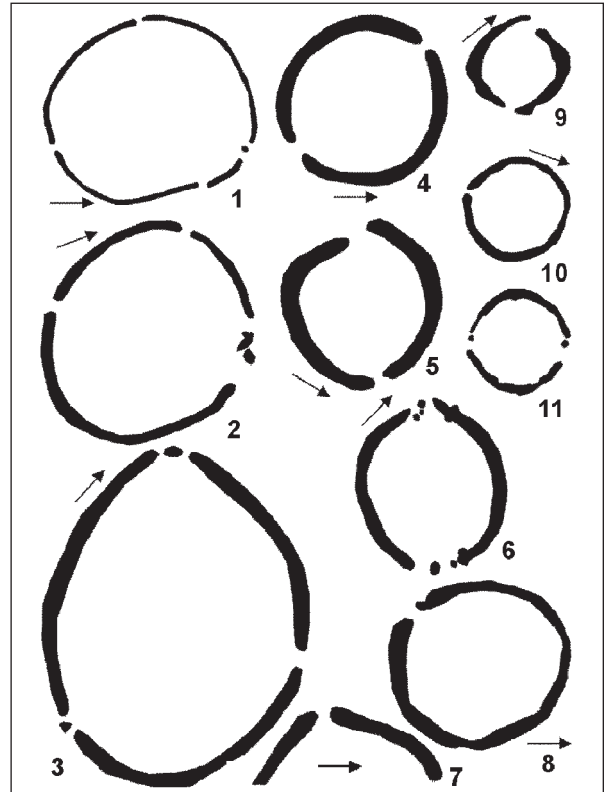

Fig. 9. Roundel typology in Slovakia: datable to the Bronze Age. 1 - Podhorany-Sokolníky; 2 - Veľký Lapáš; 3 - Veľký Cetín; possibly datable to the Neolithic period: 4 - Komjatice; 5 - Nitra-Párovské Háje; 6 - Nové Sady; 7 - Zemianske Sady; 8 - Zbehy; 9 - Alekšince; 10 - Branč; 11 - Dolné Trhovište.

circular enclosures, mainly expansion of the type range (Fig. 8; 9) are remarkable and will undoubtedly contribute to the discussion of their place and significance in the Neolithic society.

Prior to aerial prospection we only knew circular enclosures in Nitriansky Hrádok, Svodín, Bučany and Žlkovce (palisade fortification), discovered by traditional terrain methods. Today we file more than 60 circular or circle-like features of diameter 30 to 300 m and their number is increasing (Kuzma 1997, 47-58; 1998, 94-102; 2005). Especially the last years has seen a growth in the number of roundels in the wider Nitra region (approximately 25 to 30 km), where we know of more than 20 (Fig. 10).

However, not all of them can be dated to the Neolithic Period. The smaller ones of diameter 5 to 20 m come probably from different periods and should rather be associated with funereal purposes.

But we can assume that double and multiple circular features of diameter more than 60 m belong to the Lengyel Culture, although finds are missing in some cases. Verification by excavation is problematic with objects of this size. So far we have only excavated the roundel in Ružindol-Borová and with one section through all ditches also the one in Golianovo. The assumption that small-scale excavation might not give clear-cut results was confirmed. We did not find any significant material although there were enough finds and the dating was unquestionable.

On the other hand, several facts and analogies make it probable that simple "roundeloids", which have oval shapes with proportions from 80x70 to 120x100 m, can be dated back to the Bronze Age on the basis of their shape.

So far we are uncertain of circular or slightly oval ditches of 20 to 50 m, which are quite numerous. Excavation of one of the ditches with diameter of 38 m in Branč, Nitra district did not result in clear dating due to little material. However, the assumed dating to the Bronze Age does not need to be final because the ditch was V-shaped, which is typical of Eolithic roundels (the Bronze Age ditches of circular enclosures have rounded bottom), and the material came mostly from the top layer (Kuzma 1999).

RUŽINDOL, Trnava district

The circular enclosure in Ružindol is the only one of the recently found roundels where large-scale excavations have been carried out (area of 60x140 m). The results are interesting in many ways but above all from the perspective of interpretation of aerial photographs. The roundel was discovered on photographs from 1985 where it appeared as a double circle (Kuzma 1995). As double it was also photographed as a soil mark in 1989 (Fig. 11). However, the subsequent geophysical survey only confirmed the existence of one ditch with two wing-shaped entrances (Tirpák 1997). Only one ditch was also revealed in excavations in 1990, with diameter of 93 m and width of 13 m (Němejcová-Pavúková 1997). The interpretation or existence of the other ditch thus remains open. The roundel dates back to the Lengyel I phase.

KLAČANY, Hlohovec district

An exemplary double circular fortification (Fig. 12) was detected as a crop mark in 1993 (Hanzelyová, Kuzma, Rajtár 1995). Geophysical measurement was done for the first time with the Cesium magnetometer SMARTMAG SM-4G on the area of 100x100 m. Two ditches were confirmed, the diameter of the outer one being 62 m and of the inner one 35 m.

HORNÉ OTROKOVCE, Hlohovec district

The circular enclosure in Horné Otrokovce was found as a soil mark in 1988 (Kuzma/Kopecký/Rajtár 1990). On the photographs it appeared as an elliptical double circular ditch without visible interruptions (Fig. 13: 1). The subsequent magnetometric measurement was realised by proton magnetometer PM-2. The results confirmed two oval ditches: an inner ditch with the main axis 125 m and the secondary axis 95 m, and an outer ditch with the main axis 160 m and the secondary axis 130 m. The roundel has four entrances, of which the outer ones are wing-shaped. This case proves the importance of repeated documentation of some objects, since it was not before 1999 we had opportunity to photograph the roundel as a crop mark (Fig. 13: 2).

PODHORANY, Nitra district

The vertical photograph taken in 1998 by Aero Slovakia company (Fig. 14) showed two circular features in the village of Podhorany. One of them had a simple ditch and the other one had a double ditch, and both of them appeared as a soil mark.

PODHORANY-SOKOLNÍKY

During surveying in May 2001, the object was again seen as a soil mark. It appeared as a slightly oval ditch without visible interruptions. Results of aerial prospection were confirmed by geophysical survey in 2002 (Tirpák 2007, Fig. 12 in this journal). The ditch has proportions 70x60 m and can be dated to the Bronze Age.

PODHORANY-MECHENICE

In May 2002 the roundel was verified as a soil mark (Fig. 14). It appeared as a slightly irregular double circular ditch without visible interruptions. There ran another, relatively narrow linear mark approximately in the middle of the roundel.

Magnetometric measurements on the area of 165x150 m confirmed a system of two ditches. The diameter of the outer one is 120 m in north-south direction and 110 m in east-west direction. The diameter of the inner ditch is

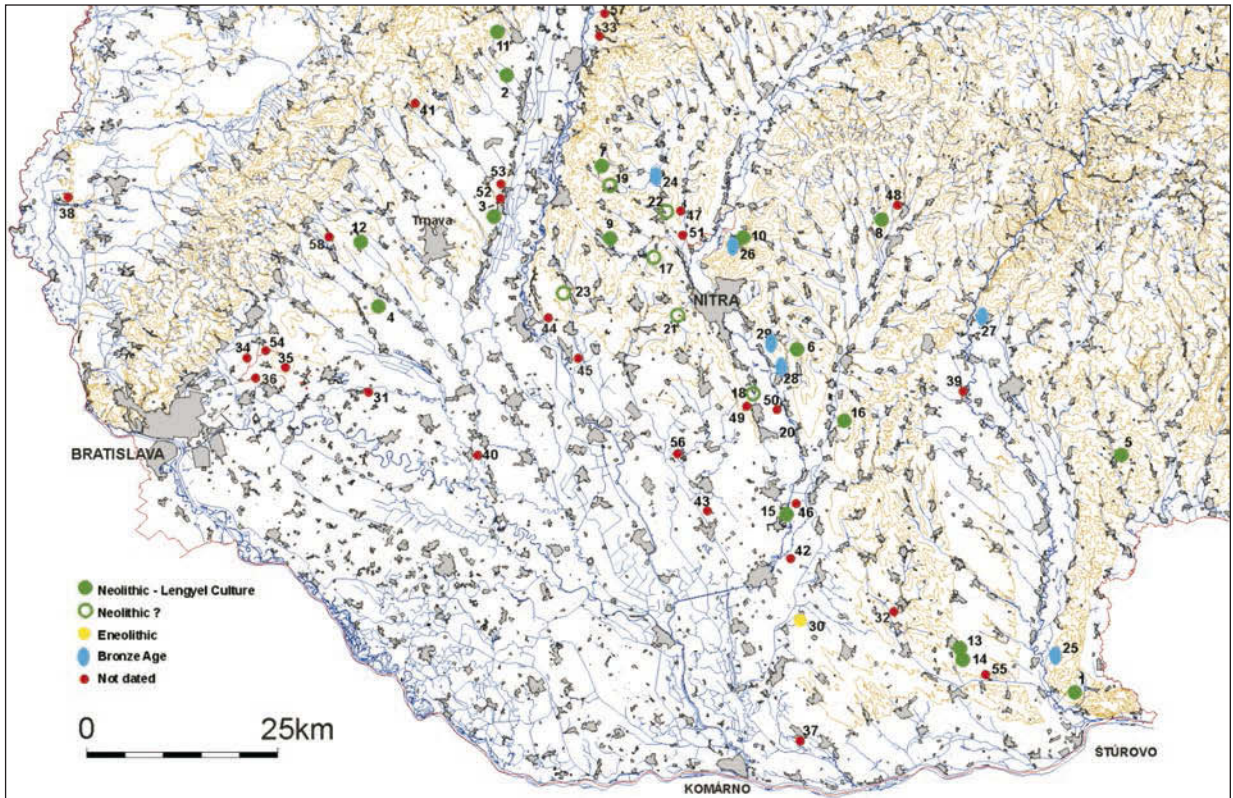

Fig. 10. Map of roundels in Western Slovakia. 1 - Bajtava; 2 - Borovce; 3 - Bučany; 4 - Cífer; 5 - Demandice; 6 - Golianovo; 7 - Horné Otrokovce; 8 - Hosťovce; 9 - Kľačany; 10 - Podhorany--Mechenice; 11 - Prašník; 12 - Ružindol-Borová; 13 - Svodín 1; 14 - Svodín 2; 15 - Šurany-Nitriansky Hrádok 1; 16 - Žitavce; 17 - Alekšince; 18 - Branč; 19 - Dolné Trhovište; 20 - Komjatice; 21 - Nitra-Párovské háje; 22 - Nové Sady; 23 - Zemianske sady; 24 - Biskupová; 25 - Pavlová; 26 - Podhorany-Sokolníky; 27 - Rybník nad Hronom; 28 - Veľký Cetín; 29 - Veľký Lapáš; 30 - Bajč-Vlkanovo; 31 - Bernolákovo?; 32 - Dubník; 33 - Ducové?; 34 - Chorvátsky Grob 1?; 35 - Chorvátsky Grob 2?; 36 - Chorvátsky Grob 3?; 37 - Chotín; 38 - Jakobov; 39 - Kálna nad Hronom; 40 - Mostová; 41 - Naháč; 42 - Nové Zámky; 43 - Palárikovo; 44 - Šintava; 45 - Šoporňa; 46 - Šurany-Nitriansky Hrádok 2; 47 - Šurianky; 48 - Topoľčianky?; 49 - Veľký Kýr; 50 - Vinodol; 51 - Zbehy; 52 - Ratkovce; 53 - Žikovce 2; 54 - Slovenský Grob; 55 - Svodín 3; 56 - Rastislavice; 57 - Modrovka; 58 - Štefanová.

90 m in north-south and 85 m in east-west direction. Maximum distance between the outer edges of the wing-shaped entrances is 145 m. The measurement confirmed four entrances orientated NNE-SSW and WNW-EES. The entrances of the inner ditch are simple, except on the west side where the entrance seems to be wing-shaped. In contrast, the outer ditch has distinct winged entrances, which are 8 to 15 m long. The length of the entire entrance corridor is 34 m at the south entrance. The width of the inner ditch entrances is 2 to 4 m, the width of the outer ditch entrances is 1 to 1,5 m.



Fig. 11. Ružindol-Borová. 1 - vertical photograph, 24 August 1985; 2 - oblique photograph, 18 November 1989.



Fig. 12. Kľačany. Oblique photograph, 6 June 2003.

Apart from the ditches linear anomalies have been detected, reaching 2 to 4 m in width and visible also on aerial photographs. They may indicate extinct road communications but they might also be ditch lines running directly through circular fortifications, which is known from several places in Germany, e.g. Neutz-Lettewitz in Saxony-Anhalt (*Braasch 1995, Abb. 20*). In field walking we obtained material which dates the roundel to Lengyel Culture.

GOLIANOVO, Nitra district

The roundel was discovered as a soil mark in April 2000 (Fig. 15: 1). It appeared as a slightly irregular, perhaps double circular ditch without visible interruptions. It was not before 2003 that the roundel was documented as a crop mark with a clearly visible course of ditches (Fig. 15: 2).



Fig. 13. Horné Otrokovce. 1 - 4 May 1994; 2 - 4 June 1999.



Fig. 14. Podhorany. Vertical photograph (Aero Slovakia 1989) and oblique photograph in the left corner, 6 April 2002.



Fig. 15. Golianovo. Lengyel culture roundel. 1 - Oblique photograph, soil mark, 16 April 2000; 2 - Oblique photograph, crop marks, 11 June 2003.

The results of the geophysical measurement were surprising. The roundel has a non-standard, almost trapezoid groundplan (*Tirpák 2007*, Fig. 5 in this journal) and it is the first triple enclosure from the territory of Slovakia so far, where the widest is the outer ditch reaching 5 to 6 m. The ditch has simple entrances, which are formed by simple interruption. However, the middle and outer ditches are interconnected at the entrances. The roundel has totally six irregularly placed entrances. As for the size, it is the largest roundel so far, with the diameter of the outer ditch approximately 178x210 m, the middle one 158x182 m and the inner one 148x167 m. Maximum distance between the outer edges of the wing-shaped entrances is 230 m.

We have also used earth machine cut all the three ditches. Profiles of the trench reached the total length of 29 m. All the ditches were V-shaped. The inner one was in the depth of 520 cm under the current surface, the middle one in 360 cm and the outer one in 400 cm. The fill of the ditch was without distinct stratification and no traces of filling, reparation or cleaning were found. The Golianovo roundel can be dated to the Lengyel I phase.

CÍFER, Trnava district

In 2001, the first quadruple roundel in Slovakia was discovered by aerial prospection (Fig. 16) as a crop mark in Cífer (*Kuzma/Tirpák 2001*). Magnetometric measurements confirmed four slightly elliptical ditches of measures

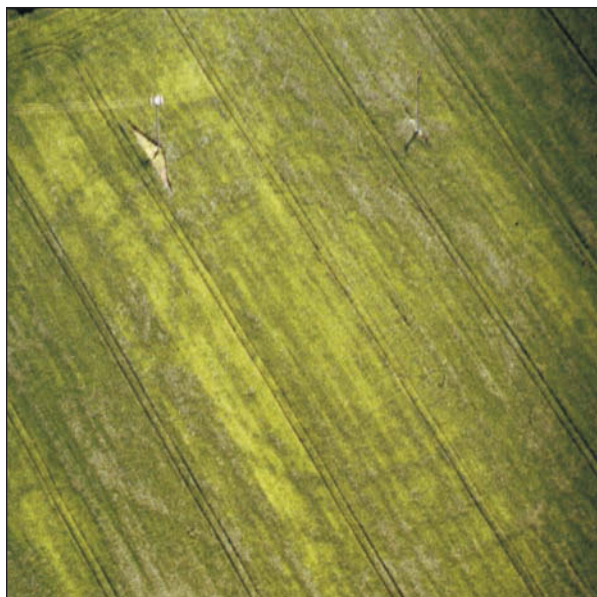

Fig. 16. Cífer. Oblique photograph, crop marks, 6 May 2001.

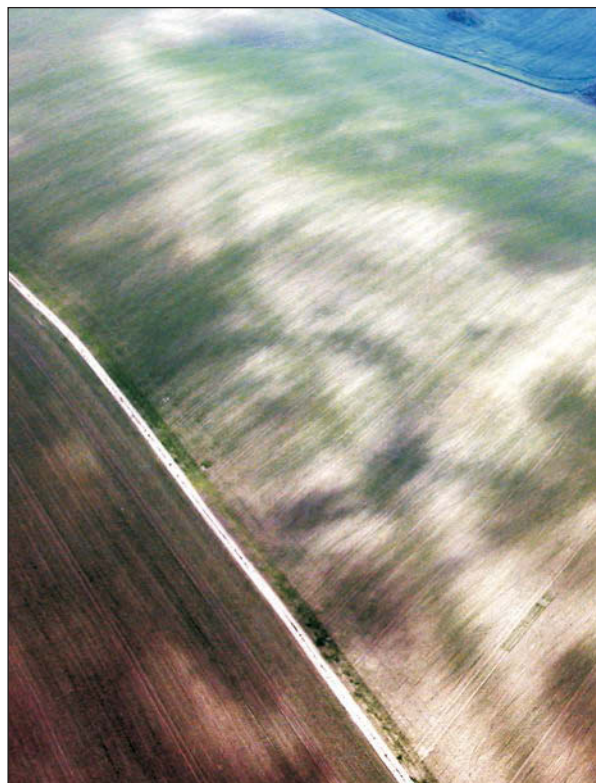

Fig. 17. Žitavce. Oblique photograph, 23 April 2004.



Fig. 18. Prašník. Oblique photograph, 16 April 2003.



Fig. 19. Hosťovce. Oblique photograph, 16 April 2003.

71×78 m, 80×84 m, 97×105 m and 114×127 m. It has four entrances orientated NNW - SSE. However, only the entrances in SWW - NEE direction are situated in a direct line opposite each other, while the other direction shows a slight deviation. The entrances of both the outer ditches and the inner ditch are formed by simple interruption. The shapes of the third ditch are combined, the entrances in NNW - SSE direction having winged shape with 10 m long wings. The mutual distance of the inner ditches as well as their distance from the two outer ones point to the possibility of two construction phases: an earlier phase with two ditches and a later one with two new ditches, while it is unclear which two of them were built in the first phase. Although field walking has not given dating material yet, most probably the roundel can be dated to the Lengyel Culture.

ŽITAVCE, Vrábľa district

The roundel was found as a soil mark in May 2001 (*Kuzma/Bartík/Rajtár 2002*). It appeared as a slightly irregular, probably double circular ditch without visible interruptions; inside there could be seen an outline of another but less visible oval (Fig. 17). The results of magnetometric measurements were once again surprising (*Tirpák 2007*, Fig. 18 in this journal). It is a system of six ditches, the diameter of the first two outer ditches being 132 and 118 m, that of the third one being 108 m and that of the other three being 75, 60 and 40 m in SW-NE direction. Analogically to Podhorany, the function of the line cutting across the roundel is not clear. As far as the interpretation is concerned, the roundel may have had several construction phases. The first phase could be associated with the four inner ditches with six

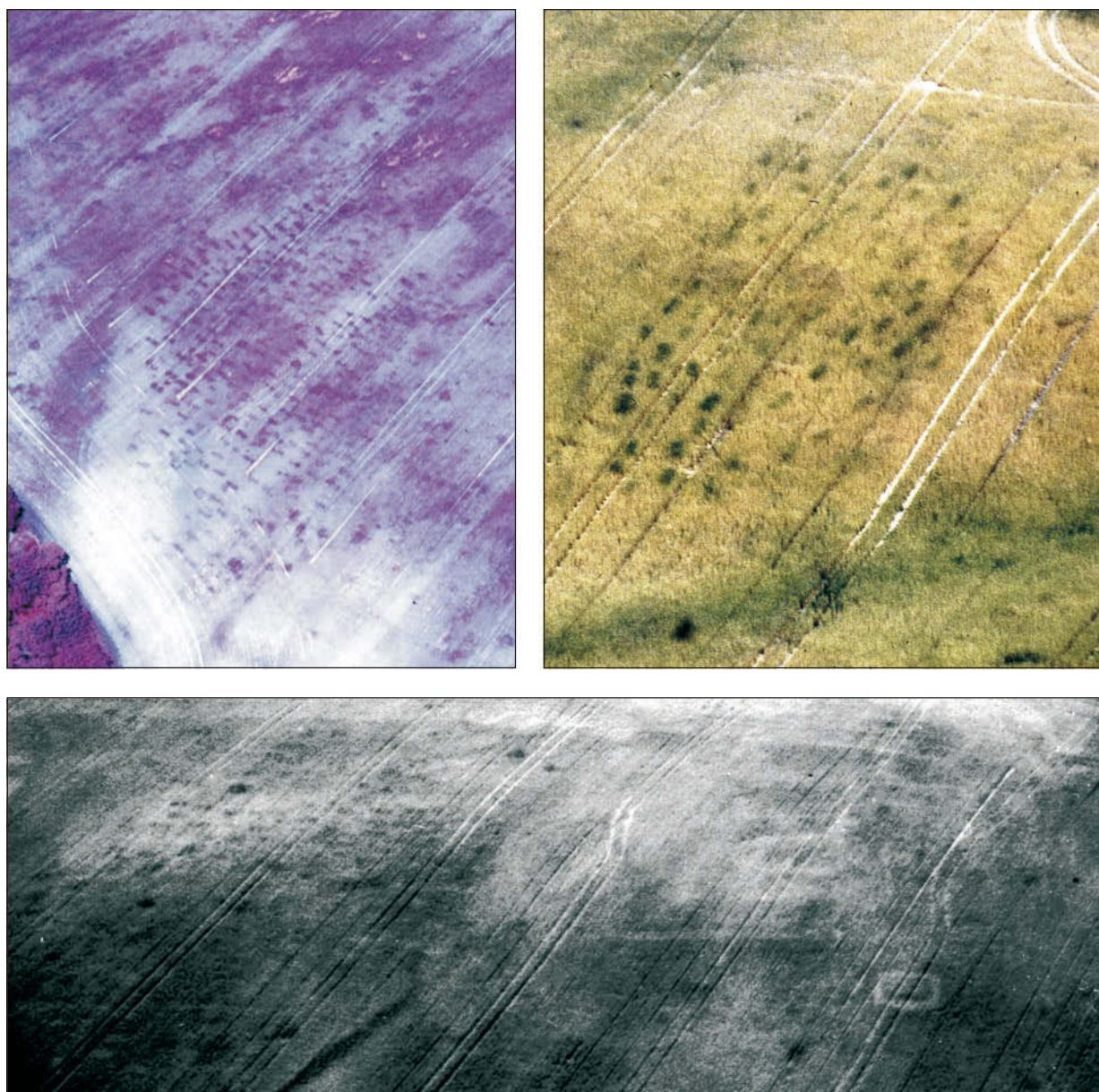

Fig. 20. Mužla. 1 - burial ground 2-4 May 1994 (photo O. Braasch); 2 - burial ground 6-13 June 2000; 3 - buried church with graveyard, 3 June 1993.



Fig. 21. Štúrovo-Obidská pustatina. Burial ground from the period of Avarian khaganathe (7-8 century), 4 May 1994.

to seven interruptions which are related to one another. The second phase could be connected with the two outer ditches with four interruptions, which are also related to the inner one. However, reverse procedure is possible.

PRAŠNÍK, Piešťany district

The circular enclosure in Prašník was detected on a vertical photograph taken on 24 August 1985 (Kuzma 2002a, 95). In May 2002 it was verified as a soil mark which formed two incomplete concentric circles (Fig. 18). It is the northernmost and at the same time the highest situated roundel on the territory of South-West Slovakia.

The roundel is situated in a moderate valley on a slope orientated in SE direction, 310 to 322 m above sea level, so that the difference in altitude between the highest and the lowest point is 12 m. This position allows for a view southeastwards but only in a rather limited angle of 80-90°. Due to this limited angle we tried the visibility range from the roundel on a terrain model (in Arc-Gis), since we in surveying in 2004 discovered a double roundel in Kočín, only 4,8 km distant. The analysis on the terrain model confirmed mutual visibility of the roundels (Kuzma/Lieskovský 2007, pp. 60 in this journal).

HOSŤOVCE, Zlaté Moravce district

The roundel was detected on a vertical photograph from 1991 where it appeared as a soil mark with two lines of ditches (Tirpák 2007, Fig. 7 in this journal). Next to it there is another circle of 60 m in diameter. It was verified in 2003 (Kuzma/Bartík 2004) by oblique photographing (Fig. 19). It is situated on a moderate slope orientated towards SW and it borders on a clear terrain rupture in the north. The diameter of the outer ditch is approximately 280x300 m, which would make it the largest known roundel.

Burial grounds

Surveying of burial grounds, burial mounds and graves with circular cairns has given positive results. Especially in searching for burial grounds aerial photographs as the only non-destructive method provide invaluable



Fig. 22. 1 - Nové Zámky, grave with a circular cairn, 7 June 1999; 2 - Svodín, 28 May 1994.

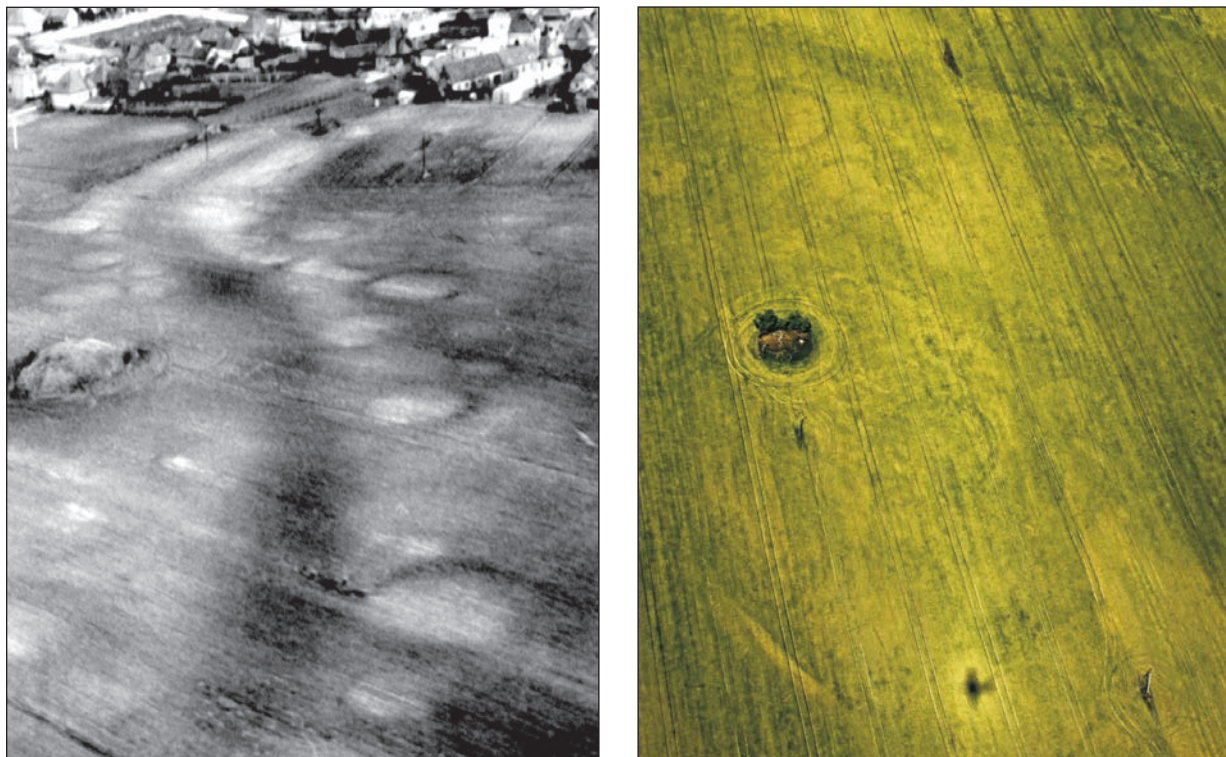

Fig. 23. 1 - Dolné Janíky. Buried burial mounds from the Hallstatt period, 15 December 1988; 2 - Reca buried burial mounds from the Hallstatt period, 21 June 2005.



Fig. 24. Dunajská Lužná. The third burial mound from the Hallstatt period, 13 June 2006.



Fig. 25. Iža. Roman stone castellum Kelemantia - 11 May 2004.

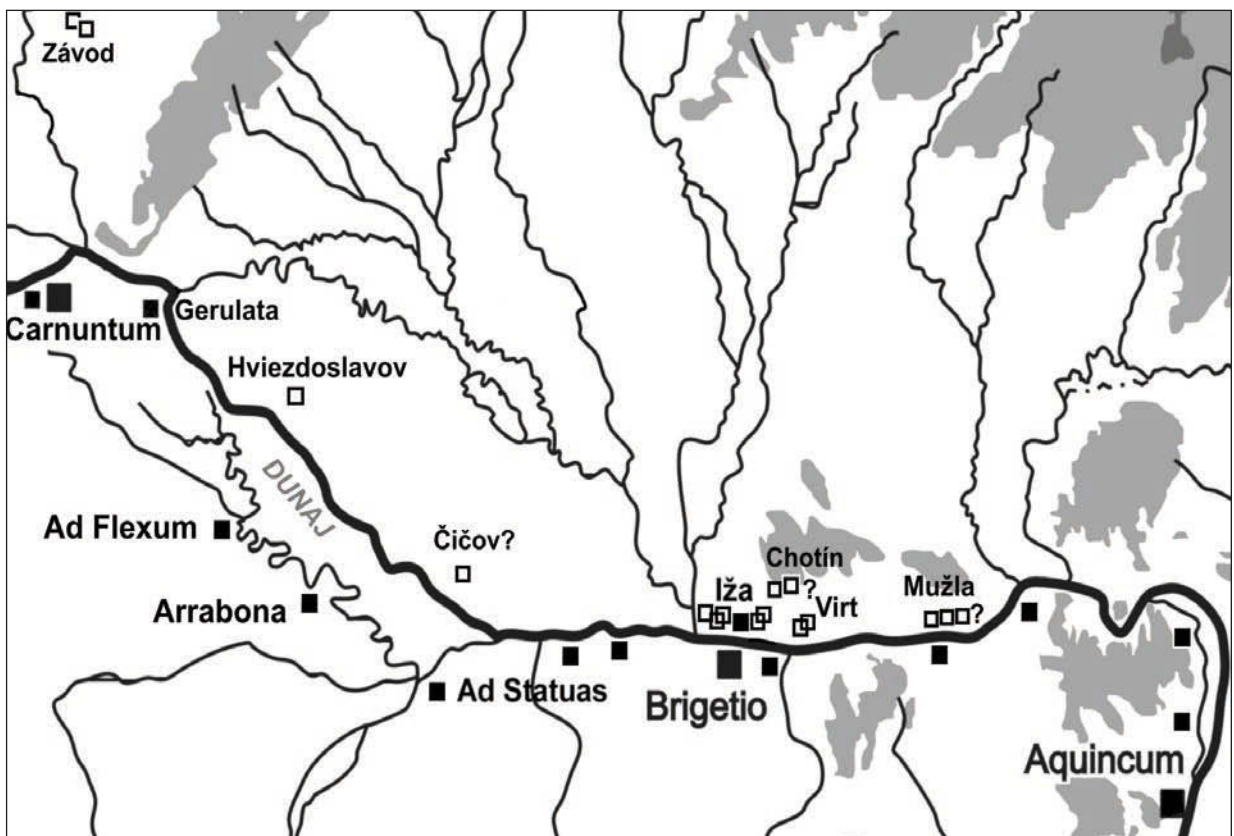

Fig. 26. Map of temporary camps from the Roman period in Slovakia.



Fig. 27. Iža, Roman temporary camps 2-4, 31 May 1990.

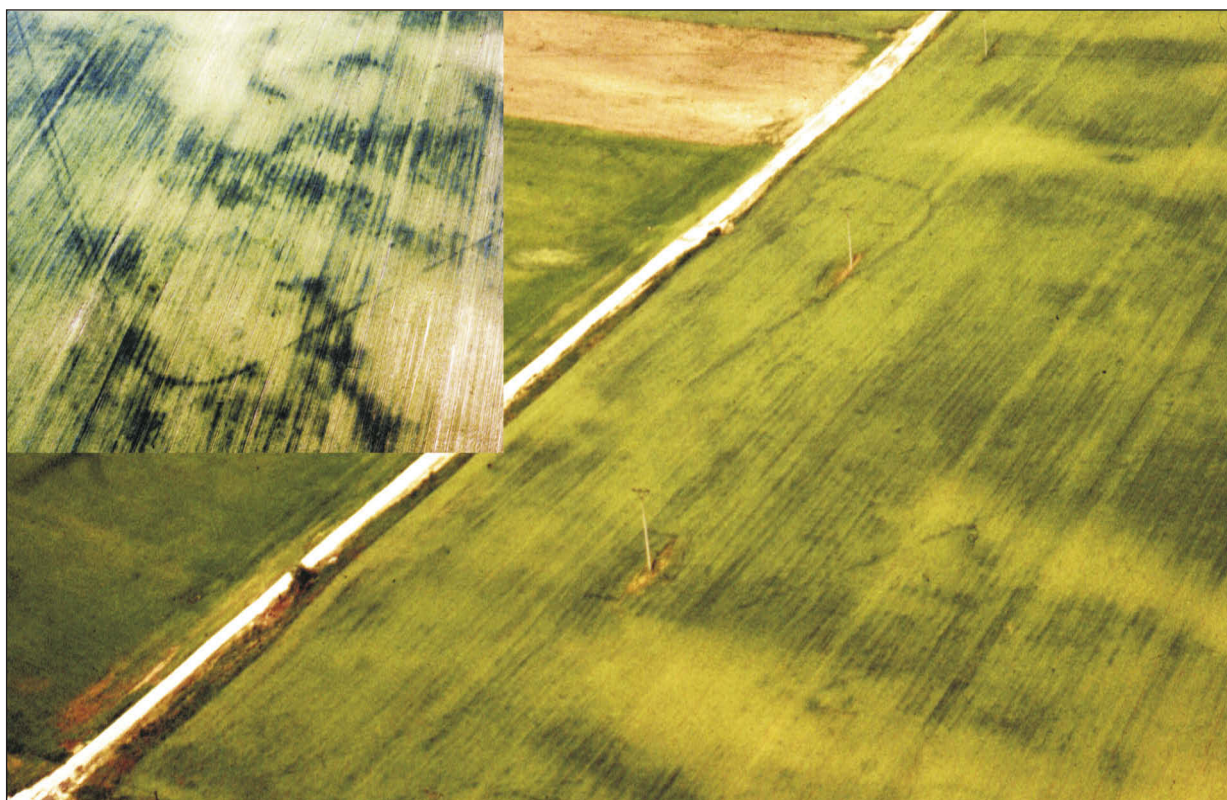

Fig. 28. 1 - Radvaň nad Dunajom-Virt. Eastern corner of camp 1 and line of the northern ditch of camp 2, 3 June 1993, in smaller photo rounded corner of camp 2.

information about their total extent and about the number and position of the graves. Geophysical methods cannot be so effectively used in this case. With regard to the fill of the graves (often filled in a short period of time) their filling has almost identical value of magnetic susceptibility as the subsoil and they do not need be detected. On the other hand, we have good results from the graves with circular gutters and sometimes from buried tumuli, where the longer period of their filling led to favourable conditions for geophysical measurement.

The most numerous so far are burial grounds. We have found six of them only in the Mužla region, on the Danube terrace in the length of 3 km. Excavation dated two of them to the period of Avar khaganate (7-8th century),

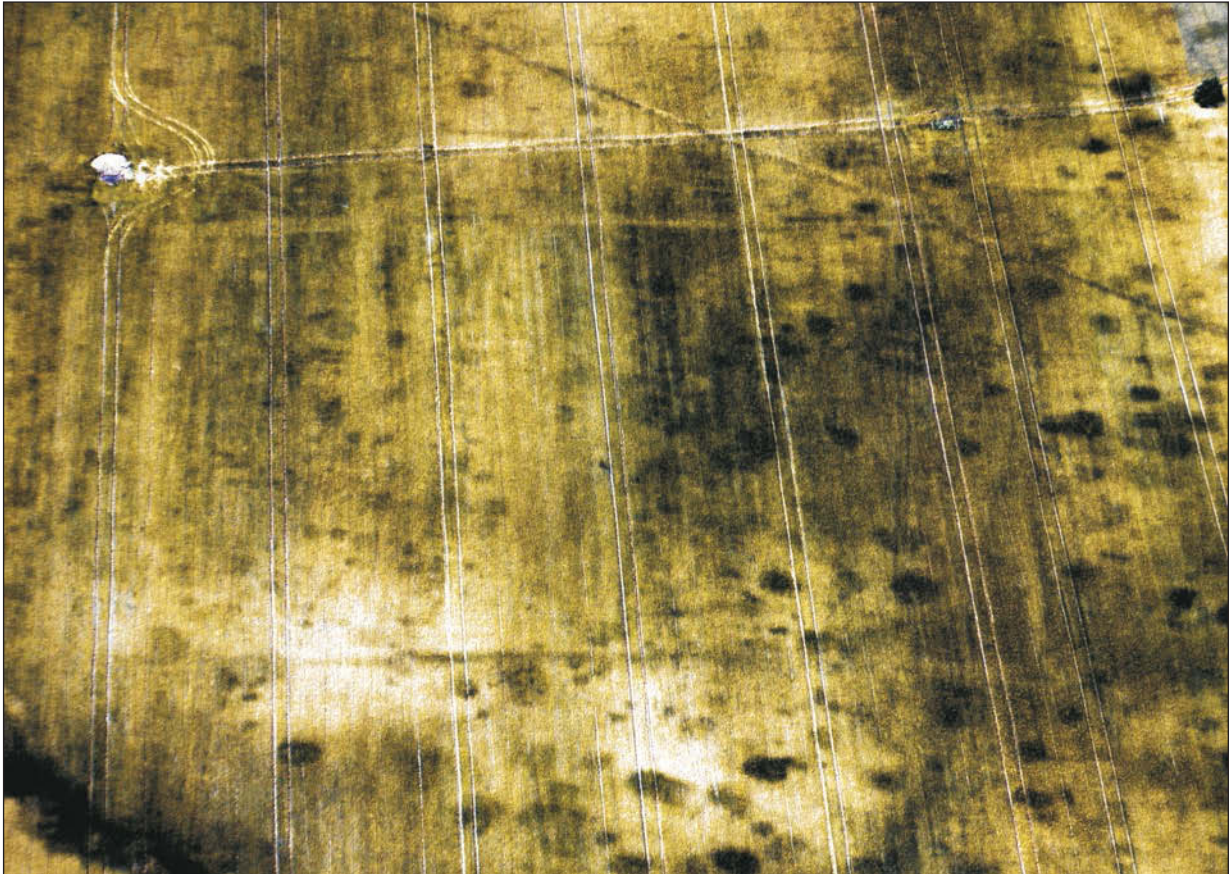

Fig. 29. Chotín. Roman temporary camp, 21 June 2005.



Fig. 30. Mužla. Camp 1, 28 May 1994.

another one to the 10-11th century and the rest, which is situated next to the ground plan of a deserted church, to the 12-13th century (Fig. 20: 3).

Particularly important are newly found burial grounds from the period of Avar khaganate. Two of them have been confirmed in excavation - Mužla-Jurský Chlm 2 (Fig. 20: 1) and Štúrovo Obidská pustatina (Fig. 21) and they supplement our knowledge of their presence in the wider Štúrovo region, where their number has risen to five (Štúrovo military training ground, Obid, Štúrovo Obidská pustatina, Mužla-Jurský Chlm 2 and 3). It is possible that the burial grounds in Mužla-Jurský Chlm 1 and Mužla 5 (Fig. 20: 1) belong to them too, perhaps also the one in Obid in position Bánom. It seems that Štúrovo region might have been a centre of Avar settlement in the same way as Komárno, where we know of seven burial grounds from this period.

SVODÍN, Nové Zámky district

The circular feature approximately 30 m in diameter and with interruptions on western and eastern sides, as well as with traces of other objects (graves?) inside is probably a burial mound (Fig. 22: 1). Orientative geophysical measurements confirmed the ditch as well as anomalies in the middle of the object. There was no sherd material but we found a circular bronze target 70 mm in diameter, with two ears on the inner side, which can be dated to the late Bronze Age.

NOVÉ ZÁMKY, Nové Zámky district

The grave with a circular cairn, which has been found on eroded dune in position Letomostie (Fig. 22: 2) is probably from Latène period. Geophysical measurement on the area of 50x50 m confirmed the course of the cairn of 7 m in diameter, as well as the existence of a grave. Other five circles 4-5 m in diameter were detected by magnetomet-



Fig. 31. Mužla. Camp 3, 10 June 2004.



Fig. 32. Hviezdoslavov. Roman temporary camp, 8 June 2000.

Five temporary camps were found in close vicinity to the fort in Iža by aerial survey in spring 1990. Today we document 13 to 16 Roman temporary camps (Fig. 26) on sites in Iža (5), Radvaň nad Dunajom (2), Chotín (1 to 2?), Mužla (2 to 3?), Hviezdoslavov (1), and in Záhorie region in Suchohrad (1) and Závod (2). Geophysical measurements on most of these sites were done by proton magnetometer PM2 but the results were mostly negative (e.g. in Iža the magnetic susceptibility of the ditch filling showed lower values than top soil). We have positive results from the camp 1 in Mužla and camp 1 in Radvaň nad Dunajom, though the latter was already measured by Cesium magnetometer.



Fig. 33. Čičov. Possible Roman temporary camp, 24 May 2000.

ric measurement though they had not been identified on aerial photographs.

Round barrow cemeteries

In the west Žitný ostrov region, within 20 km from Bratislava there are several s from Halstatt period, some of which have been surveyed in the past. We do not know the exact number of burial mounds, since most of them are no longer visible in the terrain.

Apart from the three known preserved barrows on the round barrow cemeterie from Halstatt period in Dolné Janíky traces of around 40-50 barrows (Fig. 23: 1) have been found, which copied the old river-basin of the water course. Other barrows have been found in Veľká Paka-Čukárska Paka, Reča (Fig.23: 2) and Pusté Úľany. A third barrow cemetery (Fig. 24) has been found in the area of Dunajská Lužná (originally Nové Košariská).

Roman temporary camps

Essential contribution of aerial archaeology is also in the field of Roman armies in the territory of South-West Slovakia. For a long time only one Roman stone fort was known in this region north of the Danube - that in Iža by Komárno (Fig. 25). Ancient written sources on several Roman expeditions to the barbaricum north of the Danube was the background for the hypothesis about the existence of short-term Roman military forts. However, discovery and identification of such temporary Roman camps was first facilitated by aerial prospection.



Fig. 34. Bojná. Great Moravian fortified settlement, 11 March 1998.

The only camp that has been measured completely is in Závod. Geophysical measurement confirmed ditches of a Roman temporary camp with measures 250x170 m. At the northeastern corner we have measured what is probably a part of another camp (a sector of a ditch and a corner). Both ditches intersect, which proves their different chronological origins.

IŽA, Komárno district.

Interpretation of five Roman temporary camps was unambiguous already on the aerial photographs (Fig. 27). It is interesting that the course of their ditches appeared as a negative crop mark. All camps were fortified by one ditch only and lied close to each other but they definitely did not intersect. They had rectangular, slightly oblique ground plans with rounded corners with longitudinal axis orientated approximately in west-east direction. Entrances on the shorter sides were always situated in the centre, the ones on the longer sides were in two thirds of their length, shifted towards the V. Their size was 130x90 to 210x150 m. The northern front of the largest camp was 330 m long and in front of its entrance was an advanced short sector of a ditch (*titulum*).

Excavation of the camps took place in 1992-1993. The ditches had identical regular V-shape, width of 2-2,5 m and depth of 150-170 cm. Apart from minor potsherds a denarius of Emperor Commodus, stamped for Crispina in 178-182, or 180-183, was found in the filling of one of the ditches, which confirmed their hypothetical dating to the Marcommanic wars (*Hüssen/Rajtár 1994, 219*).



Fig. 35. Velčice. Medieval fortified settlement, 23 March 2005.



Fig. 36. Liptovská Mara "Havránok". Fortified settlement of the Púchov Culture.

RADVAŇ NAD DUNAJOM, Virt and Žitva section, Komárno district

Two other camps were found not more than a few kilometres east of Iža, in the area of the village of Radvaň nad Dunajom. The first one of them - camp no. 1 - was found in survey in 1993 (Fig. 28). A part of its ditch of the south-east front, and the north-eastern rounded corner appeared as a clear crop mark in an uninterrupted line in the length of 270 m. By a testing trench was cut a huge V-shaped ditch, which went 280 cm under the current surface and was 4,5 m wide. In 1993 to 1994 we used proton magnetometer to observe the line of the north-east front of the ditch in the length of more than 800 m. The course of the ditch was interrupted in two segments. A detailed measurement confirmed that these are entrances to the camp. Both of them were protected by an titulum. We also localised northwest corner. The northeast front of the camp is approximately 830 m long, its assumed width is 600 m. The camp covered an area of around 50 ha.

Aerial prospection in 1994 not only confirmed the localisation of the northwestern corner of camp 1 but also revealed in its vicinity traces of a camp 2 (Fig. 28 in the corner). The visible part of the second camp's V-front with rounded corner was approximately 340 m long, a part of the northern front shaped as a slightly pointed line was 440 m long. The course of the ditch on the northern front of the camp 2 proves that it intersects with the ditch of the southeastern front of the camp 1, so that both camps partially intersect and were built in different phases.



Fig. 37. Kátlovce. So-called "Viereckschanze", La Tène period, 16 April 2003.

CHOTÍN, Komárno district

The camp in Chotín was found 6 km from the Danube in 1993 as a crop mark approximately 110x110 m large (Fig. 29). A testing trench in 1994 revealed a ditch 3 m wide and 130 cm deep without material. It was only in numerous repeated field walkings that we managed to obtain material which corresponds with the findings from Iža and can be dated to the same period. In addition, we found another line approximately 400-450 m long with a rather unclear existence of rounded corner. In 1994 we cut this line and uncovered a huge V-shaped ditch 4 m wide and 2,7 m deep, which could be a ditch of a temporary camp from the Roman period. However, this interpretation is premature.

MUŽLA- JURSKÝ CHLM, Nové Zámky district

Two Roman camps have been found in the village of Mužla. Camp 1 was discovered on the edge of the high Danube terrace by aerial prospection in May 1994 (Fig. 30). It was confirmed by geophysical measurements and subsequent short-term excavation. Measurements specified the ground plan and localised both corners of the northern front 135 m from one another. Excavation by three trenches fully confirmed the results of the prospection and geophysical measurements. In three sections we uncovered a ditch 2-2,2 m wide, which lied 125-130 cm in the subsoil. The fill of the ditch did not give any dating material.



Fig. 38. Pobedim. Great Moravian fortified settlement. 1 - 16 May 2003; 2 - 10 May 2004.



Fig. 39. Štúrovo. A part of the defence system of Esztergom. 1-2 -13 June 2000; 4 - 2 May 2005; 3 - map of fortification (about 1740).

The camp 2, which lies under the terrace in close vicinity of the camp 1, was identified already in aerial prospection in June 1988. In 1994, we did testing geophysical measurements and an excavation. We did not manage to observe the course of the ditch by proton magnetometer. But we uncovered by three trenches a ditch 200 cm wide and 95-125 cm deep. In one of the trenches the ditch was intersected with a German hut, which dates to the second half of the 2nd century according to the finding material.

The camp 3 was found in 2004 as a ditch with rounded corners in the distance of 500 m east of the camp 1 (Fig. 31). It is most probably a Roman temporary camp like the two previous ones.

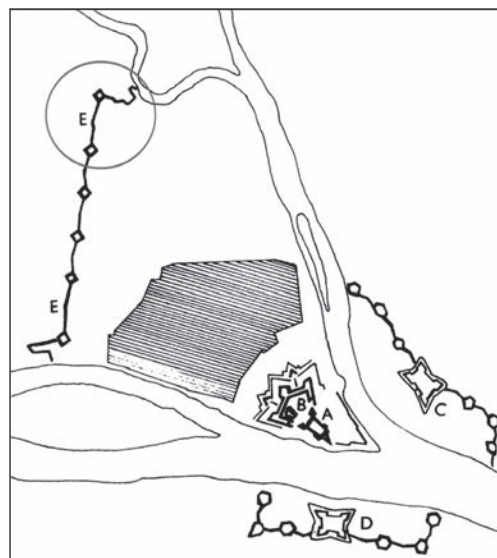
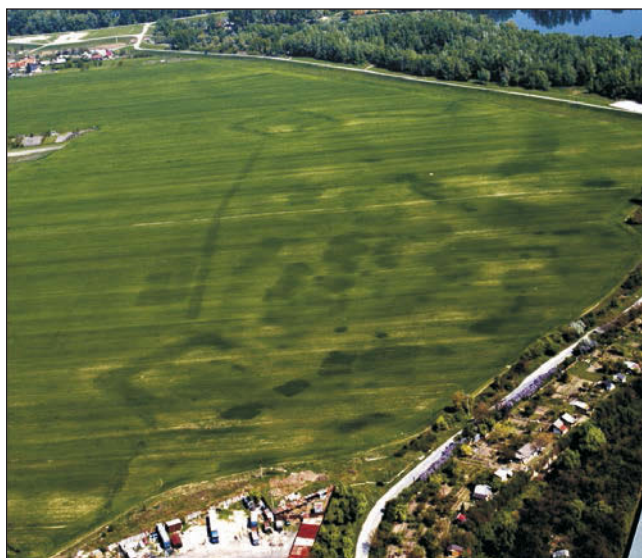

Fig. 40. Komárno. 1 - so-called Palatinus line, redoubts 5 a 6-18 May 2002; 2 - plan of Komárno fortification before 1830.



Fig. 41. Nové Zámky. Wasted church with circular fortification in form of a wall, 1988.

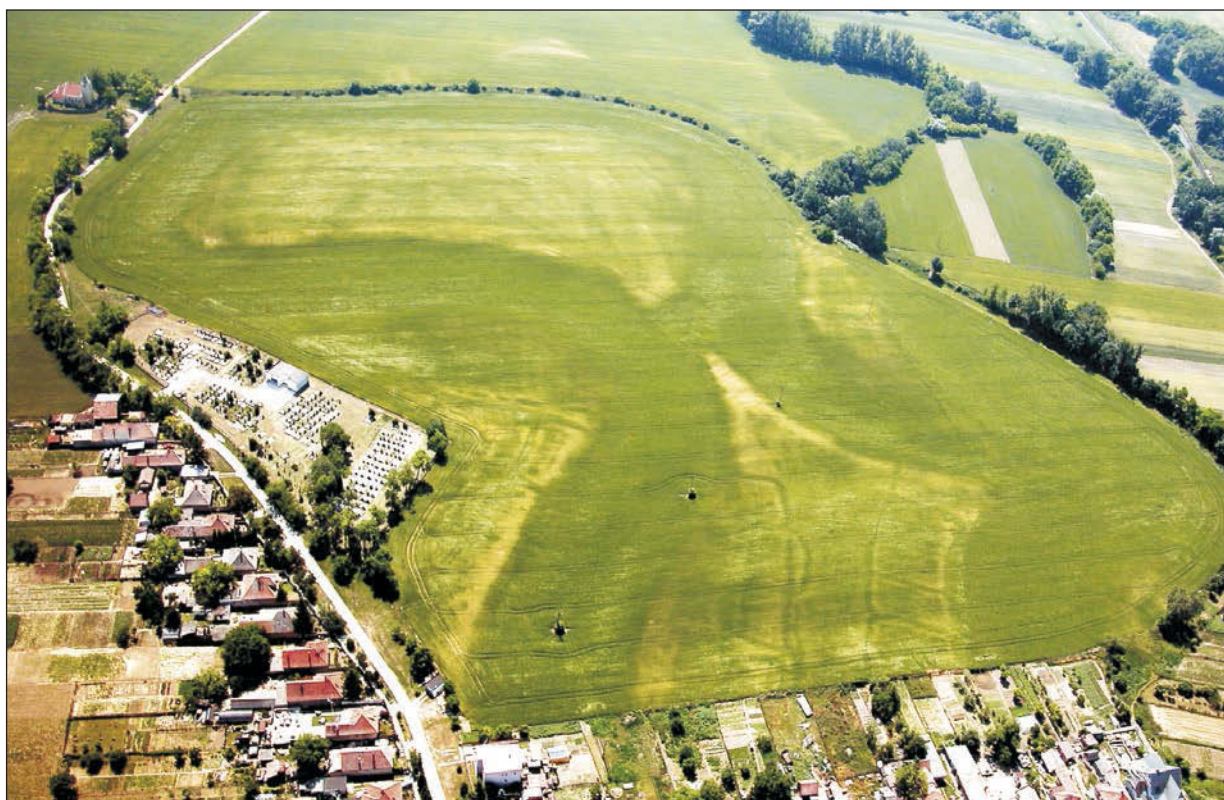

Fig. 42. Malá Mača. Deserted medieval village surrounded by the meanders, 12 June 2003.



Fig. 43. Poľný Kesov. Deserted medieval village with a church, 8 June 2000.

HVIEZDOSLAVOV, Dunajská Streda district

In 2000, a course of a ditch visible 250 and 800 m from the corner of the camp was discovered in Hviezdoslavov (Fig. 32), around 6 km from the Danube (Kuzma/Blažová/Bartík/Rajtár 2001). It is the first camp on the territory of Žitný ostrov, between Bratislava - Komárno. Although it has not been verified yet, the assumed dating is to the Marcommanic wars also in this case.

ČIČOV, Dunajská Streda district

A ditch rectangular ground plan with rounded corners (Fig. 33) was found in Čičov in 2000, in the distance of 7 km from the Danube (Kuzma/Blažová/Bartík/Rajtár 2001). In 2003, a testing trench was done (Varsik 2004, 192) but did not confirm a camp; a shallow ditch with flat bottom was found in a section. However, a 4th century Roman coin was found in field walking, which means this camp could after a detailed research also be dated to the Roman period.

The temporary Roman camps found so far are mostly situated directly on the left bank of the Danube or in its vicinity. All of them lie vis-a-vis the camps on the Hungarian side of the Danube (Fig. 26). Five of such camps in Iža were concentrated directly opposite the legionary camp Brigetio. It is obvious that the Roman troops used the protection of Brigetio several times when crossing the Danube. Also the camps in Virt, only 9 km by the Danube flow, might have been built by the Brigetio troops. Three camps in Mužla lie in a longer distance from the Danube (6 km) but still in the close foreground of the limes, vis-à-vis the camp in Crumerum

(today Nyergesújfalu). They functioned probably as defence or strategic support points, or as supplying camps on an important junction which went from this distinct terrace to the mouth of the Hron River. The camp in Hviezdoslavov is situated opposite the Roman fort Ad Flexum by Mosonmagyaróvár, and the camp in Čičov, which has not been confirmed yet, is situated in the distance of 15 km between Arrabona and Ad Statuas forts. In future we should focus on the areas situated opposite the Pannonian forts, and try to expand the number of known temporary camps on the territory of Slovakia.



Fig. 44. Čierna Voda. Ground plans of houses, 7 June 1999.



Fig. 45. Tomášov. Ground plans of houses, 6 May 2001.

Fortifications

In both hilly areas and lowlands of Slovakia we have found and documented several fortifications from different periods from prehistory to the Middle Ages. As they are hard to find in forested areas, the survey must be done especially in winter time when there is no leaf cover but with needle trees the survey is practically impossible. Good examples are the Slavic fortification in Bojná (Fig. 34) or the medieval fortification in Velčice (Fig. 35).



Fig. 46. Tomášikovo. Ground plans of houses, 7 June 1999.



Fig. 47. Orechová Potôň. Ground plans of houses, 9 June 2000.



Fig. 48. Močenok. Ground plans of houses, 17 May 2003.



Fig. 49. Komárno-Nová Stráž. Ground plans of houses, 20 July 2004.

Fortifications range from prehistoric hill forts (Fig. 36) to fortifications from La Tène period - the so-called "Viereckschanze" in Kátlovce (Fig. 37), which is the only one in Slovakia so far, to forts like the aforementioned Majcichov (Fig. 2), slavic fort in Pobedim (Fig. 38: 1, 2) and others. The large line fortifications from the Middle Ages belong here too.

ŠTÚROVO, *Nové Zámky district*

In 2000, we discovered as a positive crop mark in corn the course of a large medieval earth fortification, which was visible in the length of about 2500 m. It consisted of a straight line with several lunettes in regular intervals, with a forward redoubt with two lunettes and with a forward hexagonal redoubt with four visible bastions on the western edge (Fig. 39: 1, 2). In 2005 we photographed its termination on the eastern side (Fig. 39: 4). It is also visible on the map of Esztergom district created around 1740, where the fortification is drawn in and corresponds with our results (Fig. 39: 3). What we determined is the outer line of the fortification, while the inner one has been destroyed by a pulp mill and the inner town of Štúrovo. Although the dating of the fortification has not been confirmed, we assume it is a part of the defence system of Esztergom during the Turkish wars.

KOMÁRNO, *Komárno district*

In addition to the documentation of the current state of preservation of the Komárno fortification (Fig. 40) we have photographed the course and the two of six redoubts of the so-called Palatinum line, which no longer exists and was built in 1809 (*Gráfel 1986, 22, Fig. 4*). Fortress of Komárno was a greatest fort in Austro-Hungarian Empire and was planned for garrison of 200.000 soldiers.

Architectures and deserted villages

We have also discovered some deserted medieval villages. Very good example of the traces of such a village is from Malá Mača (Fig. 42).

Remains of stone and walled architectures have been found in smaller extent. They are mostly wasted churches, e.g. the church with a rectangular fence in Mužla district (Fig. 20c), and another with a circular once in position Letomstie in Nové Zámky (Fig. 41). Both of them have been confirmed by geophysical measurement (*Tirpák 1994*).

The most distinct example is the church in Poľný Kesov district, which was detected as a crop mark in 2000. Also traces of a deserted village with traces of the original subdivision of land were found in the church area. The church itself appeared as a lighter crop mark in corn. Around it there was a darker green circle of 30 m in diameter which appeared as a positive crop mark (Fig. 43). Although circular church fortifications in form of a wall are not exceptional, in this case we assumed a ditch, which was also confirmed by geophysical measurements. Two methods were used: magnetometric and geoelectric resistivity profiling. Magnetic measurement showed a circular ditch of 33 m in diameter. Its width ranges from 2 to 3 metres. The results of the resistivity measurement indicate the presence of the remains of foundation walls of the church with measures 16x7 m, and the foundations of supporting pillars by the western wall of the church aisle (*Tirpák 2007, Fig. 23* in this journal). The first mention of the village is from 1113 and the presence of the parish is documented in the first third of the 14th century. The village including the church was destroyed by the Turks at the end of the 16th century.

LONG HOUSES

One of the most important recent finds is a large group of sites with various numerous clusters of objects of rectangular ground plan with rounded corners, 5 to 7 m wide and up to 40 m long. In several of them division into two or more sections was visible. They are situated on dunes or elevated areas especially around the Small Danube and its tributary Čierna voda. Today we know of more than 30 sites of such ground plans in Čierna Voda (Fig. 44), Tomášov (Fig. 45), Tomášikovo (Fig. 46), Orechová Potôň (Fig. 47) and others. In several cases these are rather dense clusters of ground plans, e.g. in Močenok (Fig. 48) or in Komárno-Nová Stráž (Fig. 49).

The first and northernmost ground plans of this type were found in 1994 in Komjatice, where there were 20 of them on sand dunes. Since their dating was unclear, we realised an excavation in 2000 in order to confirm the dating and interpretation of these objects. Two ground plans of measures 12,7x7,7 and 11,4x6,6 m were uncovered. They had belt gutters 35 to 110 cm wide and 10 to 80 cm deep, which were V-shaped on most of their course. There was little material of unclear character, so that the objects could only be dated generally to the prehistoric period and their interpretation is still open (*Kuzma 2002b*). However, on the basis of analogy we can assume that they belong to the Neolithic period and that they thus represent a new housing type.

Conclusion

In the relatively short time that aerial prospection has been in use in Slovakia, we have seen its advantages in form of a number of remarkable results and valuable knowledge. The increase in the number of newly found sites itself, and the reliable data for their localisation, as well as the basic data on their size, structure and position in the landscape are a clear evidence of the effectiveness of this prospection method. Without the employment of aerial prospection many of the sites would undoubtedly remain unknown. The acquired data are of various value but they definitely form a valuable background for primary documentation and thus also for effective protection of archaeological monuments.

REFERENCES

- Bálek 1985* M. Bálek: Využití leteckého snímkování v archeologii na Moravě v roce 1983 (okr. Třebíč a Znojmo). PV AÚB za rok 1983, Brno, 113-114.
- Braasch 1995* O. Braasch: 50 Jahre verloren. In: Aerial Archaeology in Eastern and Central Europe, Forschungen zur Archäologie im Land Brandenburg 3, Potsdam, 109-122.
- Habovštiak 1971* A. Habovštiak: Archeologický výskum stredovekého obdobia na Slovensku, Slov. Arch. 19, 603-617.
- Hanzelyová/Kuzma/Rajtár 1995* E. Hanzelyová/I. Kuzma/J. Rajtár: Letecká prospekcia na juhozápadnom Slovensku. AVANS 1993, 1995, 54-58.
- Friesinger/Nikitsch 1982* H. Friesinger/R. Nikitsch Methoden und Möglichkeiten der Luftbildarchäologie in Niederösterreich. In: Fenster zur Urzeit, Horn, 21-34.
- Gráfel 1986* L. Gráfel: Pevnostný systém Komárna. Komárno 1986.
- Habovštiak 1971* A. Habovštiak: Archeologický výskum stredovekého obdobia na Slovensku. Slov. Arch. 19, 603-617.
- Hüssen/Rajtár 1994* C. M. Hüssen/J. Rajtár: Zur Frage archäologischer Zeugnisse der Markomannenkriege in der Slowakei. In: Friesinger, H./Tejral, J./Stuppner, A. (Hrsg.): Markomannenkriege - Ursachen und Wirkungen. Brno 1994, 217-232.
- Kolník 1987* T. Kolník: Letecké snímkovanie a pokusy o letecký archeologický prieskum na Slovensku. In: Archeológia - Geofyzika - Archeometria, Nitra 1987, 188-194.
- Kovárník 1985* J. Kovárník: Dosavadní výsledky leteckého archeologického průzkumu na jižní Moravě (okr. Znojmo, Brno-město). PV AÚB 1983, Brno 1985, 102-105.
- Kuzma 2002* I. Kuzma: Rondel v Prašníku. AVANS 2001, 2002, 95-96.
- Kuzma 1995* I. Kuzma: Luftbildarchäologie in der Slowakei. In: Aerial Archaeology in Eastern and Central Europe, Forschungen zur Archäologie im Land Brandenburg 3, Potsdam 1995, 251-258.
- Kuzma 1997* I. Kuzma: Die grossen Kreise der ersten Bauern. Bilder der Jungsteinzeit in Zentraleuropa. In: Oexle, J. (ed.): Aus der Luft - Bilder unserer Geschichte. Luftbildarchäologie in Zentraleuropa, Dresden 1997, 47-58, 115-140.
- Kuzma 1998* I. Kuzma: Kruhové priekopové útvary na Slovensku (súčasný stav). In: Otázky neolitu a eneolitu našich zemí. Turnov-Hradec Králové 1998, 94-102.
- Kuzma 1999* I. Kuzma: Kruhová priekopa v Branči. In: Otázky neolitu a eneolitu našich krajín - 1998, Nitra 1999, 133-142.
- Kuzma 2002a* I. Kuzma: Rondel v Prašníku. AVANS 2001, 2002, 95-96.
- Kuzma 2002b* I. Kuzma: Výskum v Komjaticiach. In: Otázky neolitu a eneolitu našich krajín - 2001. Nitra 2002, 187-194.
- Kuzma 2005* I. Kuzma: Kruhové priekopové útvary na Slovensku - aktuálny stav. In: Otázky neolitu a eneolitu našich krajín 2004. Nitra 2005, 185-223.
- Kuzma/Kopecký/Rajtár 1990* I. Kuzma/M. Kopecký/J. Rajtár: Výsledky leteckej prospekcie. AVANS 1988, 1990, 100-102.
- Kuzma/Lieskovský2007* I. Kuzma/T. Lieskovský: Analysis of roundel visibility in GIS environment. Štud. Zvesti AÚ SAV 41, 2007, 60-64.
- Kuzma/Blažová/Bartík/Rajtár 2001* I. Kuzma/E. Blažová/M. Bartík/J.-Rajtár: Letecká prospekcia na Slovensku. AVANS 2000, 2001, 112-138.
- Kuzma/Tirpák 2001* I. Kuzma/J. Tirpák: Štvornásobný rondel v Cíferi, okr. Trnava. In: P. Kouřil/R. Nekuda/J. Unger (eds.): Ve službách archeologie III. Sborník k 75. narozeninám Prof. RNDr. Jana Jelínka, DrSc., Brno 2001, 205-210.
- Kuzma/Bartík 2004* I. Kuzma/M. Bartík: Letecká prospekcia na juhozápadnom Slovensku, AVANS 2003, 2004, 108-116.
- Kuzma/Bartík/Rajtár 2002* I. Kuzma/M. Bartík/J. Rajtár: Letecká prospekcia na juhozápadnom Slovensku. AVANS 2002, 2003, 70-77.
- Mencl 1937* V. Mencl: Středověká architektura na Slovensku. Praha-Prešov 1937.
- Němejcová-Pavúková 1978* V. Němejcová-Pavúková: Další etapa výskumu vo Svodíne. AVANS 1977, 1978, 165-168.
- Němejcová-Pavúková 1997* V. Němejcová-Pavúková: Kreisgrabenanlage der Lengyel-Kultur in Ružindol-Borová. Studia Archaeologica et Medievalia, Tomus III, Facultas Philosophica Universitatis Comenianae Bratislavensis, Bratislava 1997.
- Ondrouch 1940/41* V. Ondrouch: Rímska stanica v Stupave a rímske stavebné stopy v Pajštúne. In: Historica Slovaca I/II, Bratislava 1941, 44-107.
- Schmidtová/Weberová 2004* J. Schmidtová/B. Weberová: Pokračovanie výskumu na pohrebisku z doby sťahovania národov v Bratislave-Rusovciach. AVANS 2003, 2004, 169-170.

- Tirpák 1994* J. Tirpák: Výsledky geofyzikálnych meraní pri precizovaní základov stredovekých sakrálnych stavieb na Slovensku. In: Dejiny a kultúra rehoľných komunít na Slovensku, Trnava 1994, 92-113.
- Tirpák 1997* J. Tirpák: Geophysikalische Messungen Urzeitlicher Roundelle, In: V. Němejcová-Pavúková 1997: Kreisgrabenanlage der Lengyel-Kultur in Ružindol-Borová. *Studia Archaeologica et Medievalia*, Tomus III, Bratislava, 153-156.
- Tirpák 2007* J. Tirpák: Geophysical prospecting in the slovak archaeology. *Štud. zvesti AÚ SAV 41*, 2007, 40-54.
- Točík/Vladár 1971* A. Točík/ J. Vladár: Prehľad bádania vývoja Slovenska v dobe bronzovej. *Slov. Arch.* 19, 1971, 365-422.
- Trnka 1991* G. Trnka: Studien zu mittelneolithischen Kreisgrabenanlagen. Wien 1991.
- Varsik 2004* V. Varsik: Doplnovací výskum vo Veľkom Mederi a zisťovací výskum v Čičove. *AVANS* 2003, 2004, 192-193.

Ivan Kuzma
Archaeological institute of SAS
Akademická 2
949 21 Nitra, Slovakia
ivan.kuzma@savba.sk

GEOPHYSICAL PROSPECTING IN THE SLOVAK ARCHAEOLOGY

Ján Tirpák

Key words: geophysical prospecting, Slovakia, circular and oval linear structures, fortification, architecture, Neolithic, Bronze Age, Roman period, Middle Ages

The first use of the geophysical prospecting in the Slovak archaeology has almost as long tradition as aerial photography. The first who employed geophysics, namely resistivity method, was B. Benadik from the Institute of Archaeology SAS in Nitra in 1966 by the localisation of medieval sacral building foundations on the archaeological site in Poltár. Later, the use of geophysical methods in archaeology was developed at the Department of Applied Physics of Faculty of Natural Sciences of Comenius University in Bratislava under the direction of V. Gajdoš. A need for intensive geophysical surveys grew in 1970s along with the development and construction activities in the country. Therefore, a geophysical division was founded in the Institute of Archaeology SAS in Nitra (J. Tirpák) that brought a systematic employment of geophysical methods by the excavation throughout Slovakia. Within past 30 years several thousands hectares on more than 130 archaeological sites dated from Palaeolithic to the modern era were geophysically prospected not only for Institute of Archaeology SAS but for the other organisations as well. Beside surveys on the territory of Slovakia, several missions abroad were realized, namely to Bulgaria (Drama, Krivina, Kovačevo), Romania (Porolissum), Austria (Hartberg), Hungary (Esztergom) and Kuwait (Failaka Island).

Generally, the equipment is a determining factor by application of specific geophysical method. At the beginning, the Institute of Archaeology SAS in Nitra made use of the geoelectric resistivity devices Geohm (Austria) and Minigeska (Czech Republic) and the resistivity profiling method was used. After purchase of proton magnetometers G-816 (USA) and PM-2 (Czech Republic) and conductometer EM-38 (Canada) the geophysical prospecting was enriched of magnetic and electromagnetic applications. Kappameter KT-2 from Czech Republic is being used in field for measuring the magnetic susceptibility. In 1997 a caesium magnetometer SMARTMAG model SM-4G (SCINTREX Company, Canada) and in 2004 a ground penetrating radar RAMAC-X-C-3M with shielded 250 and 500 MHz antennas from Geoscience Malå Company (Sweden) have been purchased for the Institute.

For data processing the software packages Oasis Montaj from Geosoft Company (Canada), Reflex-Win Sandmeier (Germany), and Surfer and Voxler from Golden Software Company (USA) are being used.

Results of geophysical prospecting

Below the results of geophysical prospecting of selected archaeological sites are presented. These surveys were focused on detection of following features:

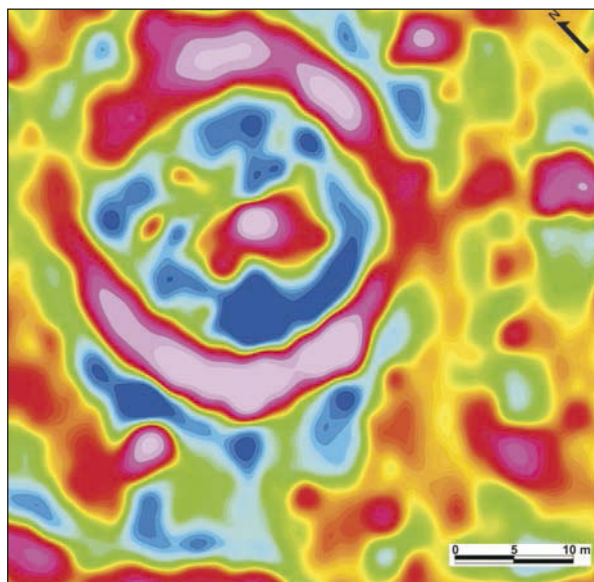

Fig. 1. Alekšince. Magnetogramm, dynamics ± 9 Nanotesla/m in 256 colour values from blue to violet.

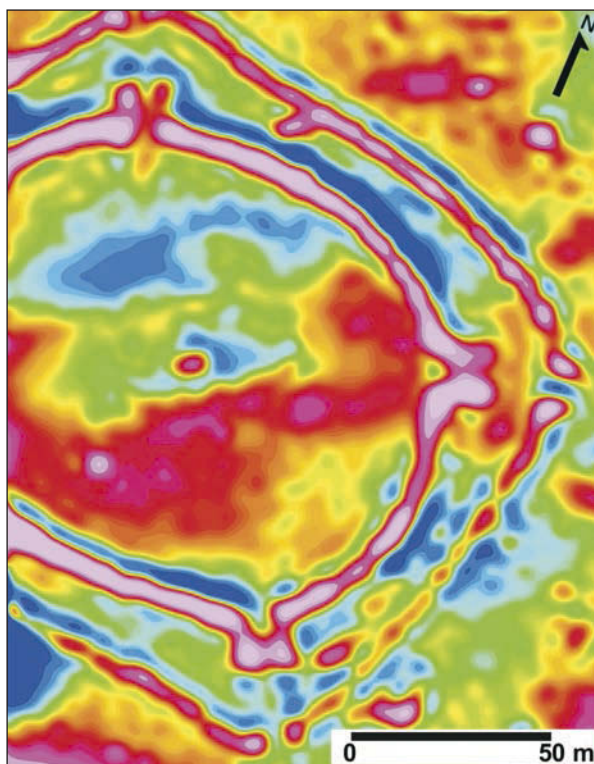

Fig. 2. Bajtava. Magnetogramm, dynamics ± 10 Nanotesla in 256 colour values from blue to violet.

- sunken features - single and multiple circular and oval linear structures, ditches, palisades, channels, fortifications and other objects within hill forts and Roman marching camps
- features with stone construction - stone masonries and their foundations, pavements, fortifications with stone construction, sacral and other covered structures - churches, chapels, monasteries, stone architecture of castles, chateaus and towns
- hollow and mined-out-features - hollows, tombs, crypts, basements and quarries.

Prehistoric single and multiple circular and oval linear structures

Around 50 such objects from the time period from the Neolithic up to the Middle Ages were identified by aerial prospecting in the south-western Slovakia and more than half of them was followingly explored by geophysical methods.

ALEKŠINCE, Nitra district

Oval fortification occurred as a cropmark and was discovered by aerial prospecting in 1996 (*Blažová/Kuzma/Rajtár 1998*). Magnetic measurement was carried out on the area 50x50 m with the point density 0,2x0,5 m in the vertical gradient mode. It resulted in the map (Fig. 1) depicting the magnetic vertical gradient anomalies of intensity -9 nT/m to 9 nT/m and width varying from 4 to 5 m. The anomalies indicate the course of the ellipsoid ditch with the main axis 32 m long, cross-axis 27 m long and with two entrances. Material found by field-walking cannot be ambiguously dated.

BAJTAVA, Nové Zámky district

Rondel occurred as a soil mark and was identified by aerial prospecting (*Hanzelyová/Kuzma/Rajtár 1996*). Geophysical prospecting could have been realized only on two thirds of the rondel (area 200x150 m, point density 0,15x0,5 m) as its remaining part was covered by vineyard. Resulting magnetic map shows anomalies with intensity -10 nT to 10 nT with width from 4 to 6 m. These anomalies form enclosed geometrical shapes; thus, they indicate the presence of two ditches. As outer ditch forms more rectangle than circle or oval, the rondel can be considered for non-standard rondel type (Fig. 2). Other anomalies with intensity from -2 nT to 2 nT run parallelly with ditches, in the space between them. From outside and inside, both ditches are bordered by anomalies of the same values. Their interpretation is not clear but it cannot be excluded that they reflect palisade grooves. Measurements of outer ditch are 188x130 m; inner ditch is 150x115 m large. Inner ditch has accentuated wing entrances that reach length up to 16 m. Outer ditch shows only traces of wing entrances that are bowed inside on its NW edge and they reach the length 6 m. The length of SW entrance corridor is 34 m, of NE 37 m and of NW 38 m. The width of the inner ditch wing entrances is 5 m; the width of outer ditch wing entrances varies from 2 to 5 m. The rondel can be dated to Lengyel I according to the material from archaeological survey (*Kuzma/Tirpák 2006a*).

BRANČ, Nitra district

Circular ditch fortification of 35 m diameter was identified by aerial prospecting as a cropmark (*Blažová/Kuzma/Rajtár 2000*). The course of the ditch was verified by magnetic measurement of the area 50x50 m with the point

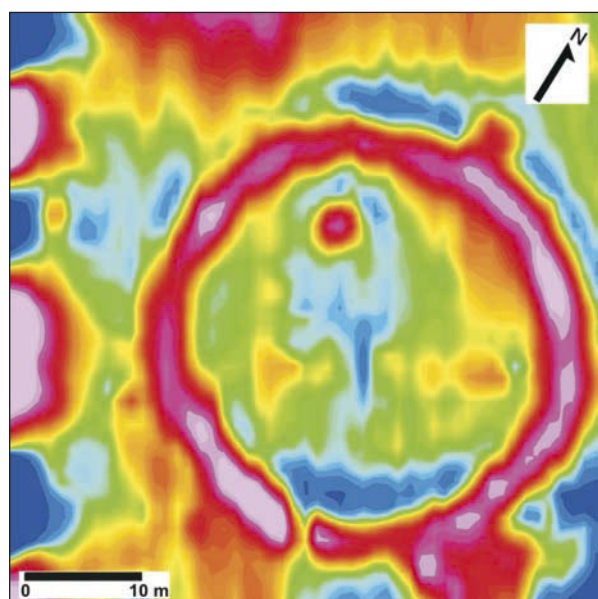

Fig. 3. Branč. Magnetogramm, dynamics +/-10 Nanotesla in 256 colour values from blue to violet.

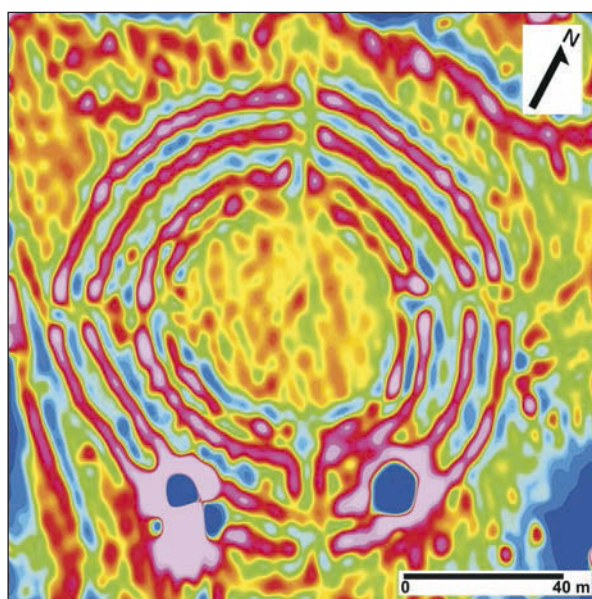

Fig. 4. Cífer. Magnetogramm, dynamics +/-10 Nanotesla in 256 colour values from blue to violet.

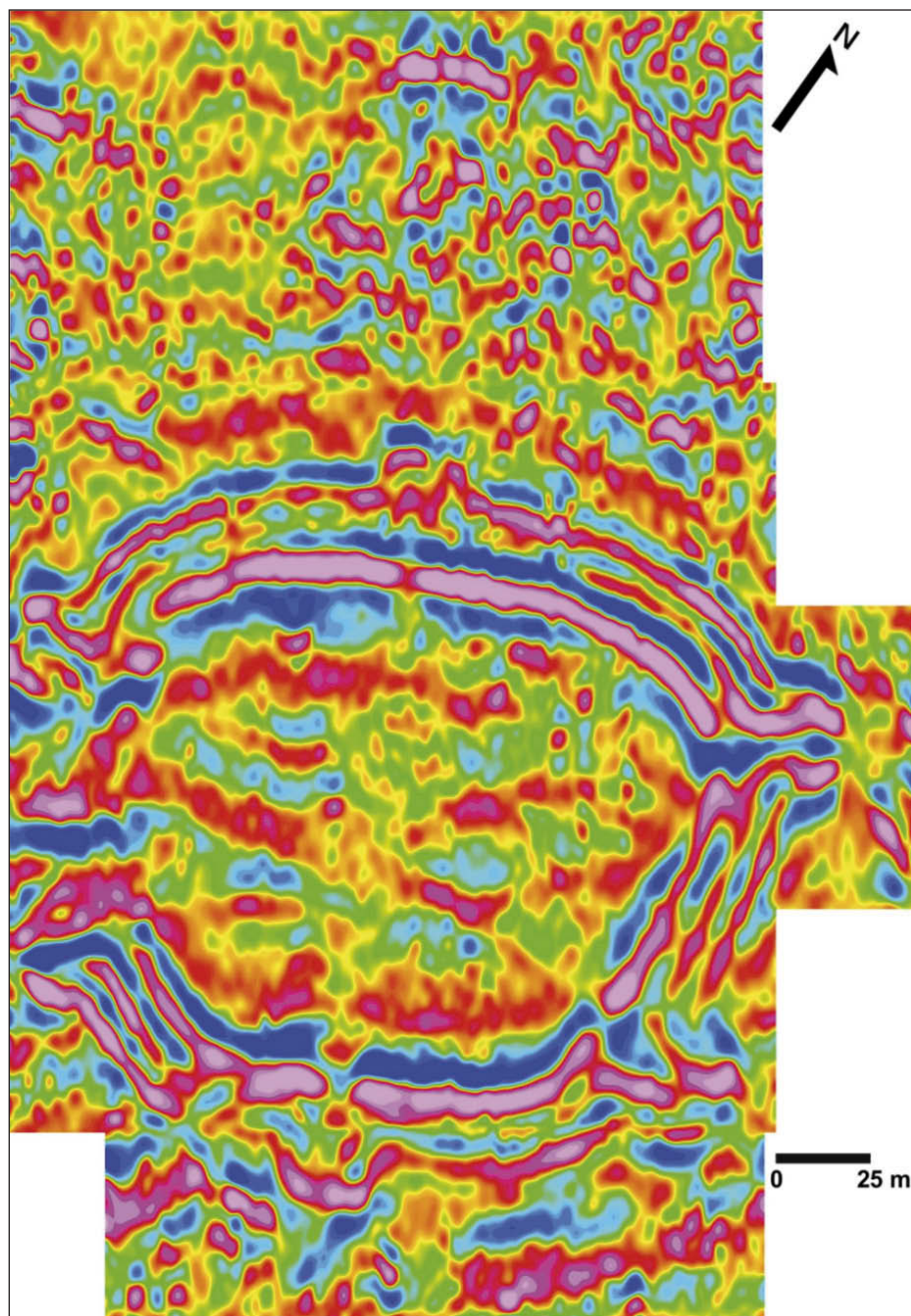

Fig. 5. Golianovo. Magnetogramm, dynamics +/-15 Nanotesla in 256 colour values from blue to violet.

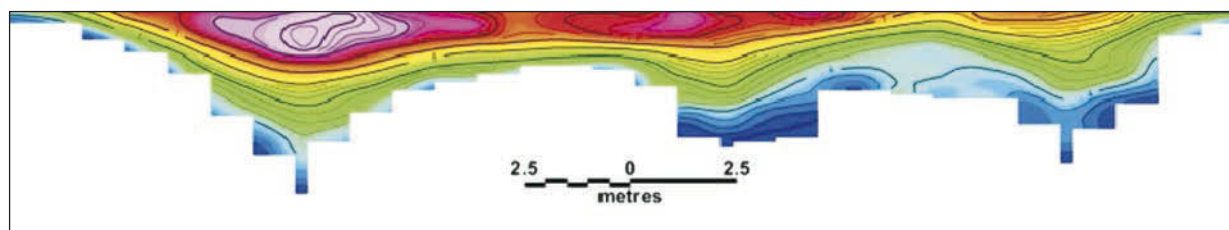

Fig. 6. Golianovo. Vertical profile of apparent magnetic susceptibility, dynamics from $0,1 \cdot 10^{-3}$ to $3,3 \cdot 10^{-3}$ u. SI in 256 colour values from blue to violet.

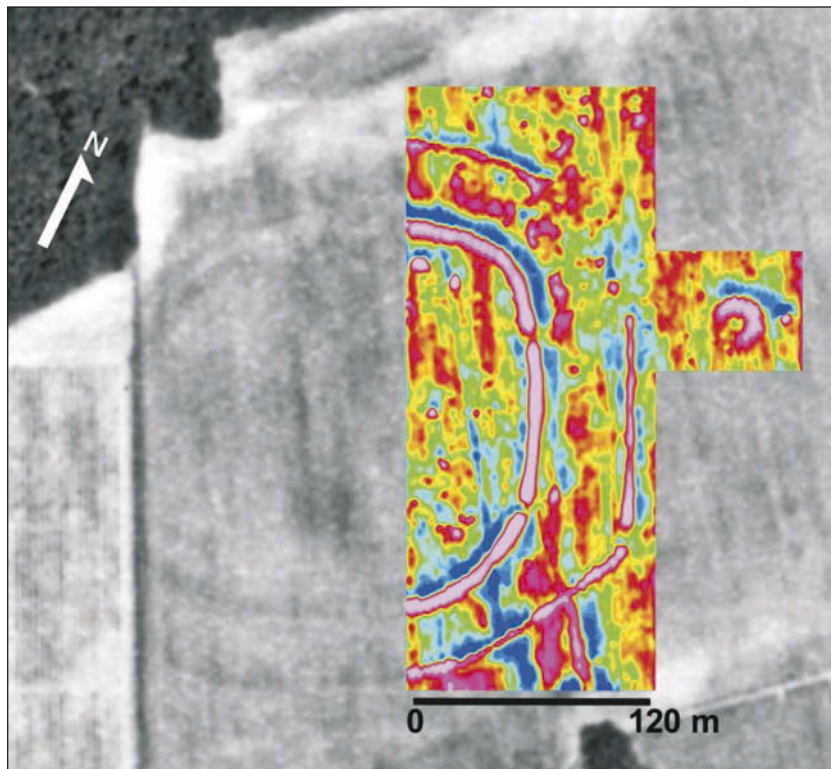

Fig. 7. Hosťovce. Magnetogramm, dynamics +/-10 Nanotesla in 256 colour values from blue to violet.

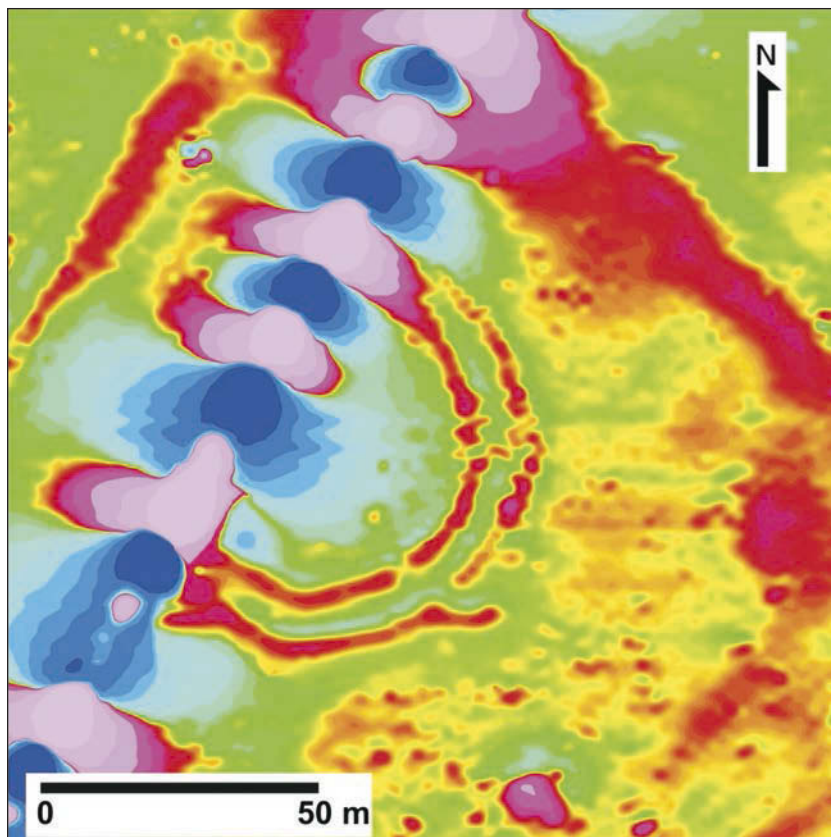

Fig. 8. Kočín. Magnetogramm, dynamics +/-10 Nanotesla in 256 colour values from blue to violet.

density 0,2x0,5 m. It is possible to specify anomalies with intensity -10 to 10 nT on the map of residual magnetic anomalies that reflect the shape of the ditch of diameter ca. 38 m and show an interruption in the southern part of this circular structure. Furthermore, anomalies indicating perhaps settlement structures could have been defined on the prospected area. Archaeological excavation under the direction of I. Kuzma revealed ditch fortification datable to the Early Bronze Age (Kuzma 1999).

CÍFER, Trnava district

Quadruple rondel was detected as a cropmark by aerial prospecting (Kuzma/Bartík/Rajtár 2002; Kuzma 2007, Fig. 16 in this journal). Magnetic measurement was carried out on the area 150x150 m with the point density 0,15x0,5 m. Linear anomalies with intensity -10 to 10 nT and from 2 to 4 m wide can be specified on the magnetic map (Fig. 4). These anomalies form enclosed geometric shapes and reflect a Neolithic rondel with four entrances and four ditches with diameters 60 m, 71 m, 84 m and 114 m. Only the ditch of 71 m diameter has wing entrances along the N - S axis. Along with the linear anomalies, the isolated isometric anomalies of the width up to 5 m were identified with intensity from -5 to 10 nT (Kuzma/Tirpák 2001b). These anomalies probably reflect archaeological objects such as pits, sunken dwellings etc. Measurements were negatively influenced by presence of three ferro-concrete poles on the prospected area.

GOLIANOVO, Nitra district

Magnetic measurements were carried out on the area 420x215 m with the point density 0,15x0,5 m that was specified on the basis of the results of aerial prospecting (Kuzma/Blažová/Bartík/Rajtár 2001; Kuzma 2007, Fig. 15 in this journal). On the map of total vector of magnetic field (Fig. 5) it is possible to specify positive linear anomalies with intensity -15 to 15 nT and width from 3 to 10 m. These anomalies form enclosed geometric shapes and reflect the course of the ditches of a rondel. Along with linear anomalies, isolated isometric anomalies with intensity -5 to 10 nT were identified. The width of these anomalies is up to 5 m and they probably reflect individual archaeological features. According to geophysical measurements, the rondel has trapezoid ground plan and massive 5 to 6 m wide inner ditch with simple entrances that are formed only by interruptions in the course of the ditch. Middle and outer ditches are connected by striking wings in entrances. Rondel has total 6 entrances. Measurements of outer ditch are 180x210 m, middle ditch has 160x180 m and inner ditch 150x170 m (Kuzma/Tirpák 2001b).

To verify the results of geophysical prospecting, the ditches were cut in their northern part. This archaeological excavation under the direction of I. Kuzma (2005) confirmed the information obtained by geophysical measurements. Rondel can be dated to Lengyel I. Vertical section of archaeological trench was measured for magnetic attributes of apparent magnetic susceptibility (Fig. 6).

HOSŤOVCE, Zlaté Moravce district

Rondel was detected as a cropmark (Kuzma/Bartík 2004; Kuzma 2007, Fig. 19 in this journal). It appeared to be a double-ditch fortification system.

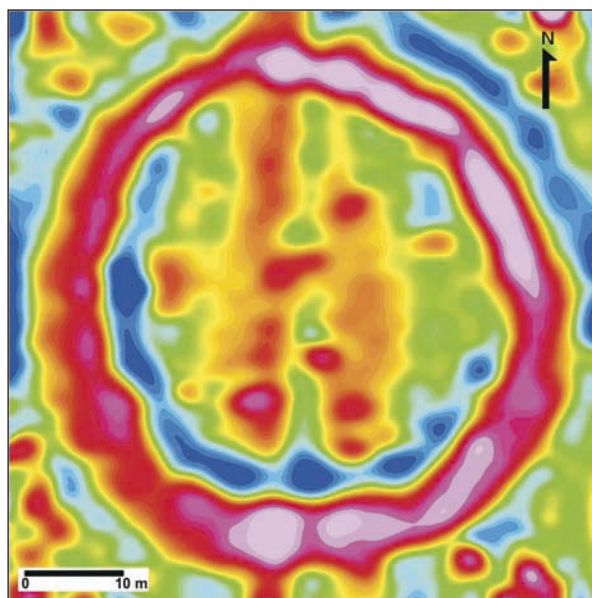

Fig. 9. Komjatice. Magnetogramm, dynamics +/-10 Nanotesla in 256 colour values from blue to violet.

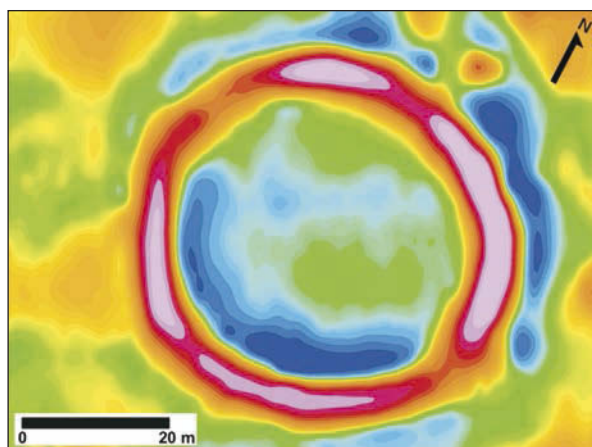

Fig. 10. Nové Sady. Magnetogramm, dynamics +/-10 Nanotesla in 256 colour values from blue to violet.

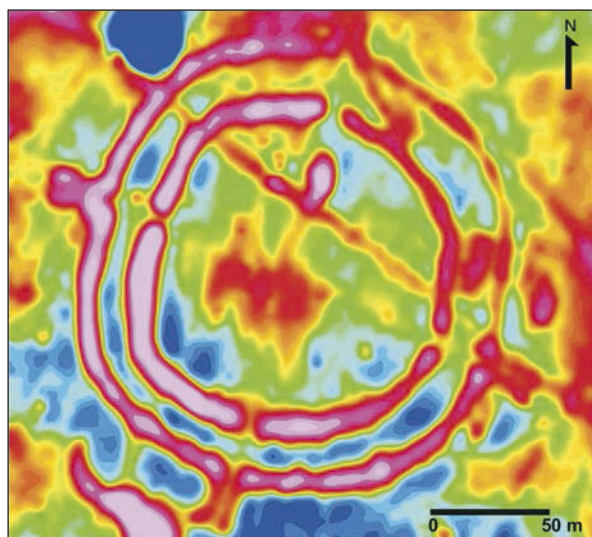

Fig. 11. Podhorany - Mechenice. Magnetogramm, dynamics +/-15 Nanotesla in 256 colour values from blue to violet.

Magnetic measurement was realized on the area 300x200 m with the point density 0,15x0,5 m. On the map of residual magnetic anomalies (Fig. 7) the circular anomalies with intensity -10 to 10 nT and width from 3 to 6 m can be specified. These anomalies reflect the ground plan of a rondel with two ditches. Rondel has probably six entrances. The diameter of outer ditch is 280m in N - S direction and of inner ditch 200 m also in N - S direction. East of rondel a semicircular anomaly with intensity -5 to 6 nT and measurements 20x20 m was detected. Along with the linear anomalies of intensity 5 nT and width of 1 - 2 m, the isometric anomalies with intensity -5 to 5 nT were identified that are caused by archaeological structures of present settlement (Kuzma/Tirpák 2006b).

KOČÍN, Trnava district

Circular double-ditch system occurred as a cropmark (Kuzma/Bartík 2006). Magnetic measurement was carried out on the area 150x150 m with the point density 0,2x0,5 m. It resulted in the map of residual magnetic anomalies (Fig. 8) where it is possible to specify anomalies with intensity from -50 to 50 nT. Anomalies with intensity from -10 to 10 nT are concentrated into two enclosed ditches with four interruptions. Outer ditch has diameter 75 m, inner ditch 60 m. Outer ditch has wing entrances on the southern side. The northern side has probably the same shape but it is disturbed by modern gasoline that causes difficulties by its interpretation.

KOMJATICE, Nové Zámky district

Archaeological structure of circular shape was identified on the vertical topographic photographs (Kuzma 1992). Magnetic measurement was carried out on the area 60x60 m with the point density 0,2x0,5 m in vertical gradient mode. It resulted in a map (Fig. 9) depicting the course of magnetic vertical gradient anomaly in which it is possible to specify anomalies with intensity -10 to 10 nT/m indicating presence of a ditch of 50 m diameter with four interruptions. Noteworthy are two ditches in the south-western part of a rondel. Field walking yielded only indistinct material from Neolithic through the Bronze Age up to the Middle Ages.

NOVÉ SADY, Nitra district

Rondel occurred as a cropmark (Kuzma/Bartík 2004). It appeared as a circular ditch without visible interruptions. Magnetic measurement was realized on the area 70x70 m with the point density 0,15x0,5 m. It is possible to specify a linear anomaly of intensity from -10 to 10 nT on the map of residual magnetic anomalies (Fig. 10). This anomaly forms enclosed circular shape - 4 to 5 m wide ditch of a rondel with measurements 54x50 m. Rondel has two simple entrances along E - W axis. Dating of this prehistoric rondel is not precised yet. Although there were few sherds of Linear Pottery culture recognized among materials from rondel, such dating is not probable (Kuzma/Tirpák 2004a).

PODHORANY - MECHENICE, Nitra district

Rondel was detected as a soil mark during aerial prospecting (Kuzma/Bartík/Rajtár 2002; Kuzma 2007, Fig. 14 in this journal). Magnetic measurement was realized on the area 145x150 m with the point density 0,2x0,5 m. Geophysical measurements on the site was processed as a map of residual magnetic anomalies (Fig. 11) where it is possible to specify anomalies of circular shape with intensity from -15 to 15 nT and width from 4 to 6 m. These anomalies form two ditches system - a rondel with four entrances. Diameter of outer ditch is 120 m in N - S direction and 110 m in E - W direction. The diameter of inner ditch is 85 m in N - S direction and 80 m in E - W direction. Advanced

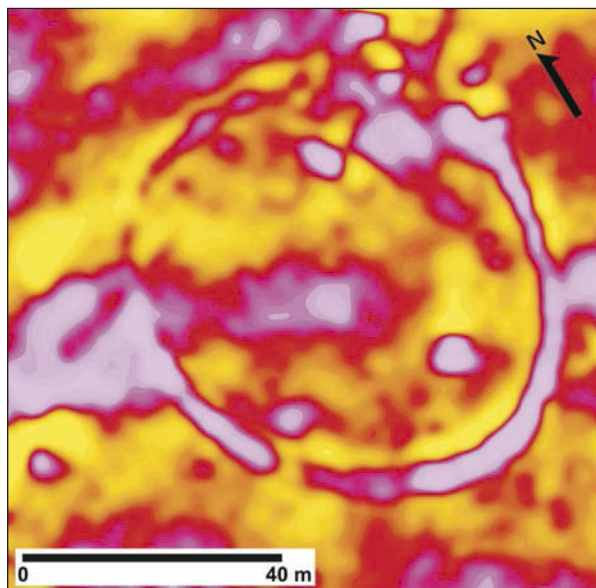

Fig. 12. Podhorany-Sokolníky. Magnetogramm, dynamics +/-10 Nanotesla in 256 colour values from blue to violet.

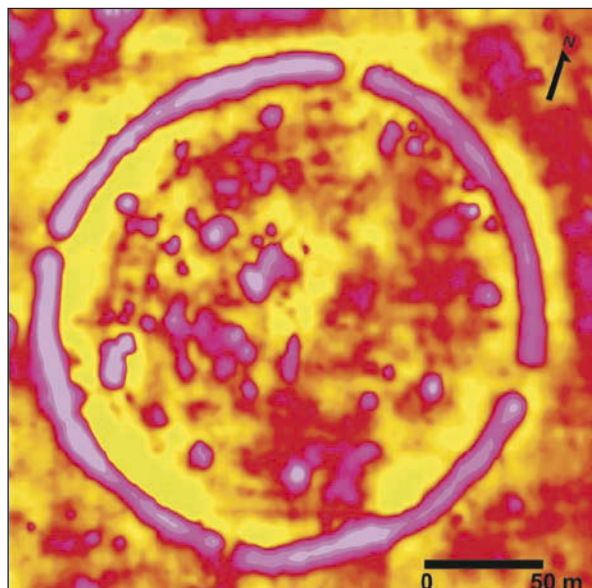

Fig. 13. Prašník. Magnetogramm, dynamics +/-11 Nanotesla in 256 colour values from blue to violet.

four wing entrances can be identified by outer ditch. Along with three linear anomalies with intensity 5 nT and width from 1 to 2 m, the isolated isometric anomalies with intensity from -5 to 10 nT were identified. Average width of the latter varies from 5 to 8 m. The origin of linear anomalies can be probably searched in old roads while isometric anomalies were caused by settlement archaeological objects (Kuzma/Tirpák 2004c).

PODHORANY - SOKOLNÍKY, Nitra district

Rondel was detected by aerial prospecting as a soil mark (Kuzma/Bartík/Rajtár 2002). Magnetic measurement was carried out on the area 90x90 m with the point density 0,2x0,5 m. On the magnetic map (Fig. 12) anomalies of oval shape with intensity from -10 to 10 nT and width from 2 to 4 m can be specified. Residual magnetic anomalies form ellipsoid object with the 70 m long main axis and 60 m long cross-axis. Supposedly, they represent a prehistoric rondel with three entrances. Apart from linear anomalies, the isolated isometric anomalies with intensity from -3 to 5 nT and average width up to 5 m were identified. Magnetic anomalies probably indicate archaeological structures, such as pits, sunken dwellings etc. (Kuzma/Tirpák 2004c).

PRAŠNÍK, Piešťany district

Rondel in Prašník was identified on the vertical topographic image and verified by aerial photography (Kuzma 2002; Kuzma 2007, Fig. 18 in this journal). It occurred as rather indistinct soil mark represented by two incomplete concentric circles. Magnetic measurement was carried out on the area 150x150 m with the point density 0,15x0,5 m. On the magnetic map (Fig. 13) the anomalies with intensity from -11 to 11 nT and width from 4 to 7 m can be specified. They reflect a ditch of 130 m diameter. Measurement confirmed four simple entrances along N - S as well as E - W axis with the width from 3 to 6 m. Other linear anomalies with intensity from -2 to 2 nT run parallelly with the ditches and they probably represent palisade grooves. Anomalies of isometric shape with the same values probably indicate archaeological objects such as pits. Unlike aerial photographs, geophysical measurement confirmed only one ditch (Kuzma/Tirpák 2006c).

RUŽINDOL, Trnava district

The only one from recently discovered rondels where extensive archaeological excavation was realized on the area 60x140 m is situated in Ružindol. Its results are interesting from several perspectives, primarily from the point of view of aerial photographs interpretation. It was identified on the topographic images from 1985 where it appeared like a double circular structure (Kuzma 1995; Kuzma 2007, Fig. 11 in this journal). In 1989 it was also photographed as a double linear soil mark.

Consequent geophysical measurement was carried out with an objective to precise the area of identified fortification. Magnetic method was employed on the site; proton magnetometer PM-2 for the area 190x175 m with the point density 1x1 m and caesium magnetometer for the area 150x100 m with the point density 0,15x0,5 m.

Measurements resulted in the maps of residual anomalies for both proton (Fig. 14a) and caesium (Fig. 14b) magnetometers. The results confirmed only one ditch with two advanced wing entrances (Tirpák 1997). It is represented by two semicircular linear anomalies with magnetic intensity from -15 to 15 nT and width from 5 to 10 m. These anomalies face each other and end up in wing entrances. Inside rondel the isometric and less striking linear anomalies with intensity from -5 to 8 nT were identified. Archaeological excavation also proved only one ditch of the rondel with diameter 93 m and with the width 13 m (Němejcová-Pavúková 1997). It can be dated to Lengyel I.

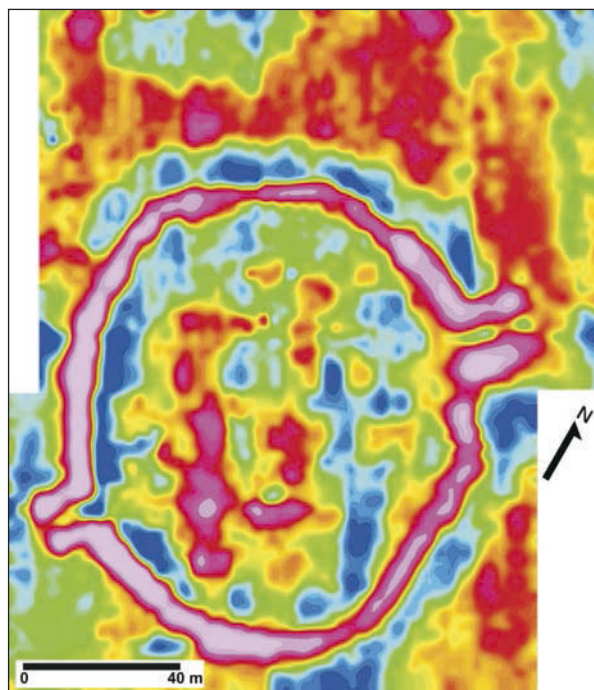

Fig. 14a. Ružindol. Magnetogramm, dynamics +/-15 Nanotesla in 256 colour values from blue to violet (proton magnetometer).

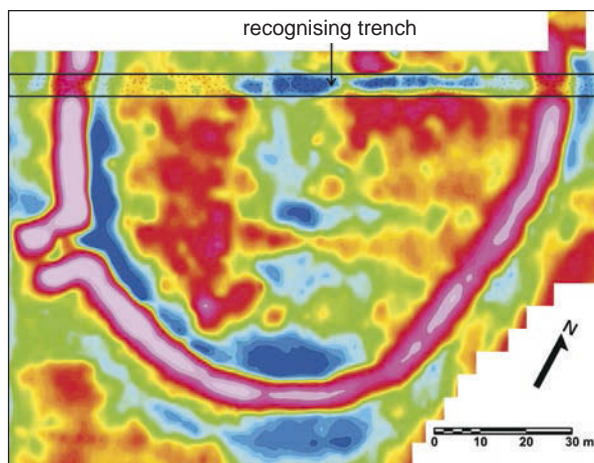

Fig. 14b. Ružindol. Magnetogramm, dynamics +/-15 Nanotesla in 256 colour values from blue to violet (caesium magnetometer).

VELKÝ CETÍN, Nitra District

Rondel was detected by aerial prospecting as a soil mark (Kuzma/Hanzelyová/Rajtár/Tirpák 1996). Magnetic measurement was realized on the area 120x90 m with the point density 1x1 m. On the magnetic map (Fig. 15) the anomalies with intensity from -10 to 10 nT and width from 3 to 5 m can be specified. Residual magnetic anomalies concentrate into enclosed ellipsoid shape with the main axis 95 m long and cross-axis 70 m long. It is probably a circular enclosure from the Bronze Age with three entrances. Moreover, the isolated isometric anomalies with intensity from -4 to 7 nT and width up to 5 m were identified that probably indicate archaeological features such as pits, sunken dwellings etc.

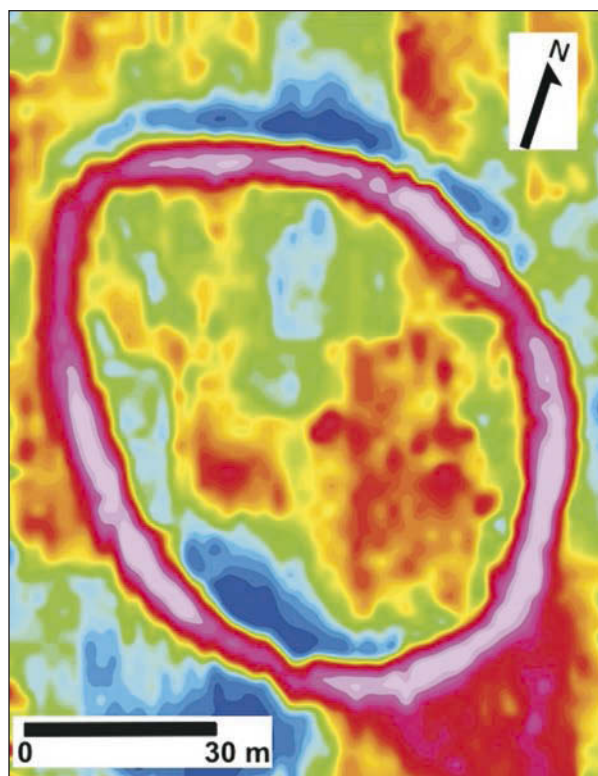

Fig. 15. Velký Cetín. Magnetogramm, dynamics +/-10 Nanotesla in 256 colour values from blue to violet.

VELKÝ LAPÁŠ, Nitra district

Rondel was detected by aerial prospecting as a soil mark (Kuzma/Bartík/Rajtár 2002). Magnetic measurement on the area 100x100 m with the point density 0,2x0,5 m revealed anomalies of oval shape with intensity from -10 to 10 nT and width from 2 to 4 m (Fig. 16). Residual magnetic anomalies concentrate into enclosed ellipsoid shape with the main axis 80 m long and cross-axis 70 m long. It is probably a circular enclosure from the Bronze Age with three entrances. Also isolated isometric anomalies were identified with intensity from -3 to 5 nT and width up to 5 m. They probably indicate archaeological features such as pits, sunken dwellings etc.

ZEMIANSKÉ SADY, Nitra district

Rondel occurred as a soil mark on aerial photographs (Kuzma/Tirpák 2004b). It appeared as slightly oval ditch without visible interruptions. Magnetic measurement was realized on the area 70x70 m with the point density 0,15x0,5 m. Linear anomaly with intensity from -8 to 8 nT can be specified on the map of residual magnetic anomalies (Fig. 17). It forms enclosed slightly ellipsoid shape - a ditch with measurements 45x51 m. From interpretation of the magnetic map it is obvious that the ditch is 4 to 5 m wide and rondel has simple entrances along NE - SW axis. Other linear anomalies with intensity -8 nT were identified in the northern part of the rondel. Anomaly 15 m south of rondel has intensity up to 4 nT.

On the basis of few fragments the rondel can be dated generally to the prehistory, perhaps to the Neolithic.

ŽITAVCE, Nitra district

Rondel was detected by aerial prospecting in 2001 as a soil mark (Kuzma/Bartík/Rajtár 2002; Kuzma 2007, Fig. 17 in this journal). Magnetic measurement was carried out on the area 160x150 m with the point density 0,15x0,5 m. On the magnetic map (Fig. 18) the anomalies with intensity from -12 to 12 nT and width from 2 to 6 m can be specified. Magnetic anomalies concentrate into enclosed geometric shapes that reflect six ditches system presumably from more chronological phases. According to the archaeological material the rondel can be dated to the Neolithic. The first building phase is represented by outer ditches with four entrances where ditches have diameters 132 m, 118 m and 108 m. The second building phase is represented by inner ditches with six entrances. Along with the linear anomalies, the isolated isometric anomalies with intensity from -3 to 8 nT and average width up to 8 m were identified. These anomalies are probably caused by archaeological features such as pits, sunken dwellings etc. (Kuzma/Tirpák 2003).

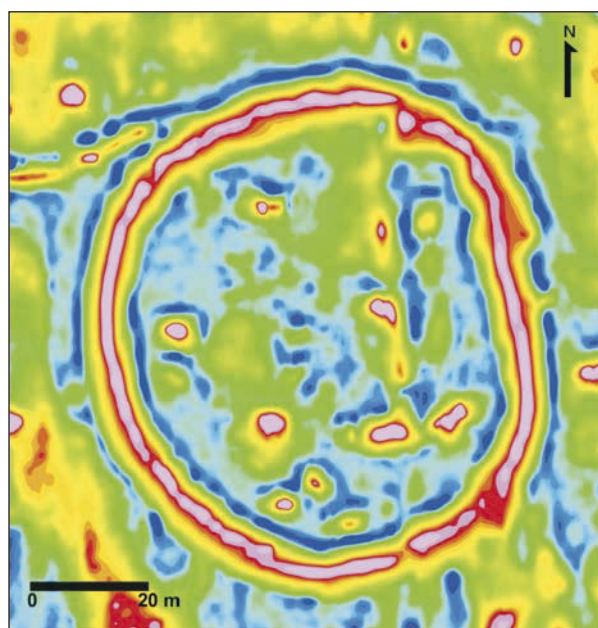

Fig. 16. Velký Lapáš. Magnetogramm, dynamics +/-10 Nanotesla in 256 colour values from blue to violet.

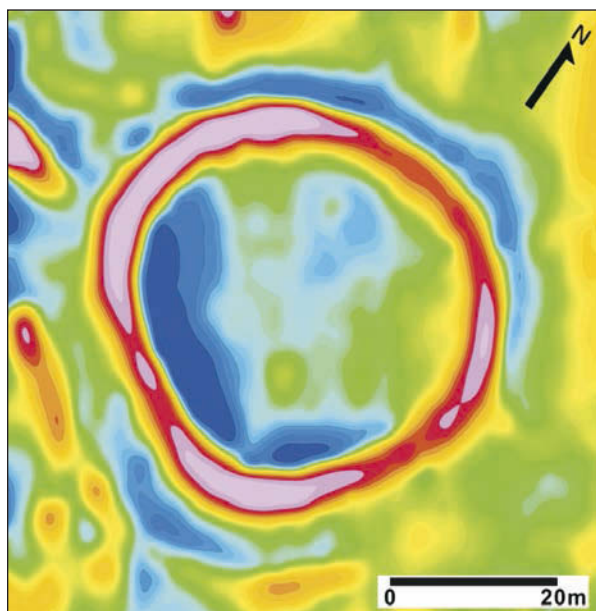

Fig. 17. Zemianske Sady. Magnetogramm, dynamics ± 8 Nanotesla in 256 colour values from blue to violet.

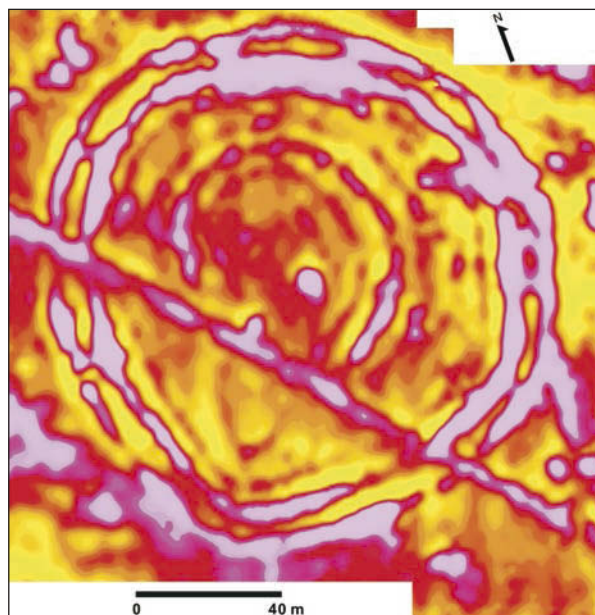

Fig. 18. Žitavce. Magnetogramm, dynamics ± 12 Nanotesla in 256 colour values from blue to violet.

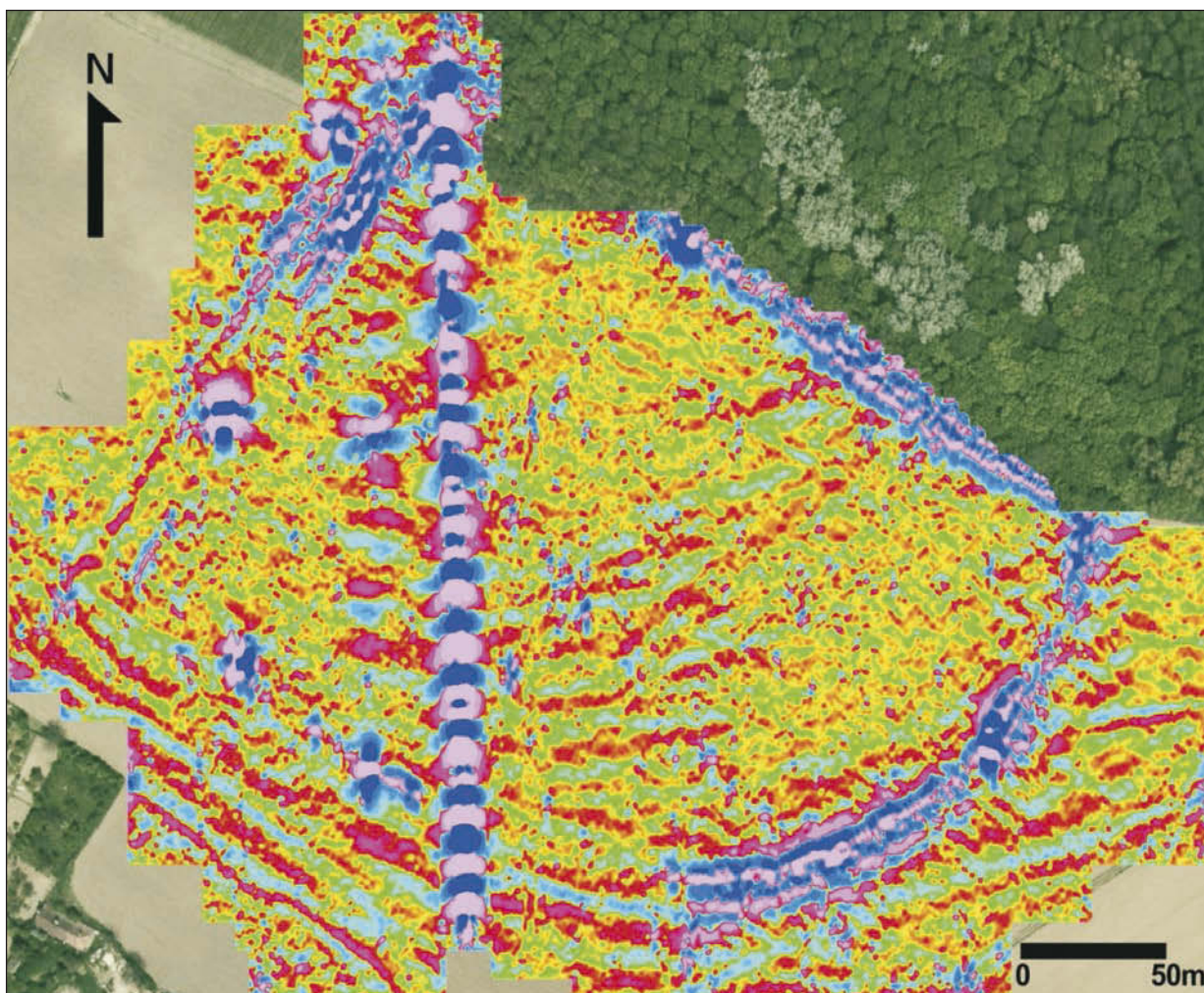

Fig. 19. Majcichov. Magnetogramm, dynamics ± 15 Nanotesla in 256 colour values from blue to violet.

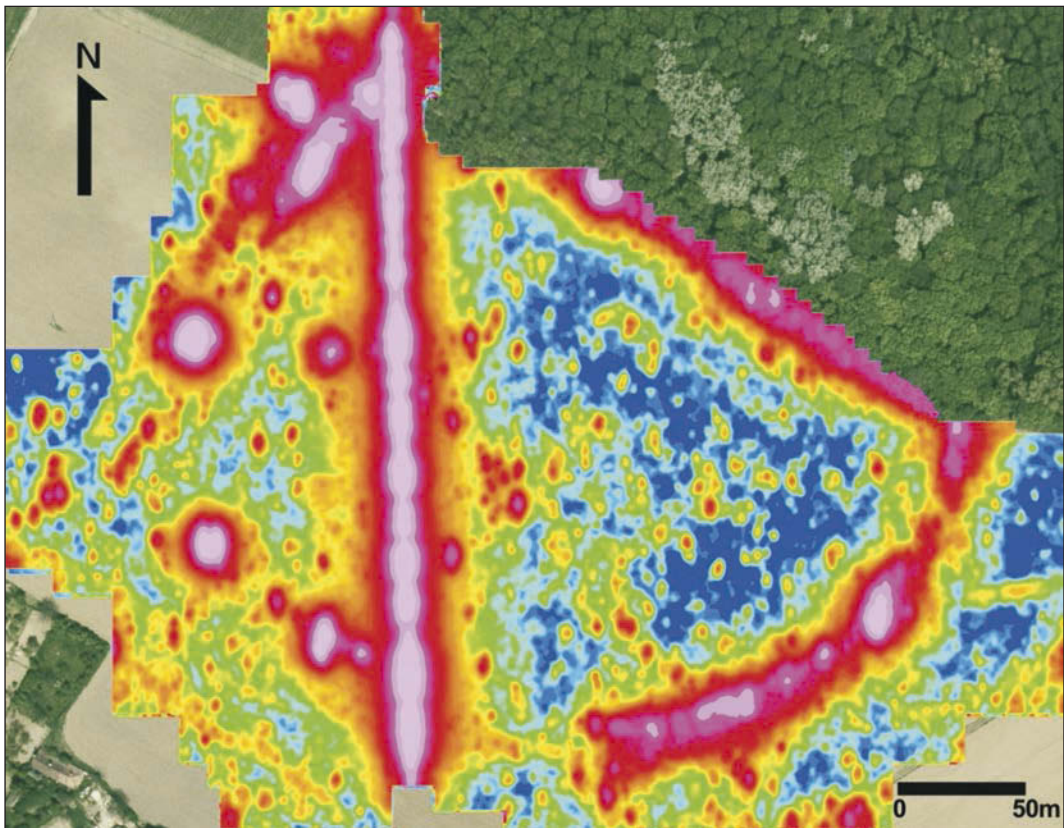

Fig. 20. Majcichov. Map of analytic signal of magnetic field.

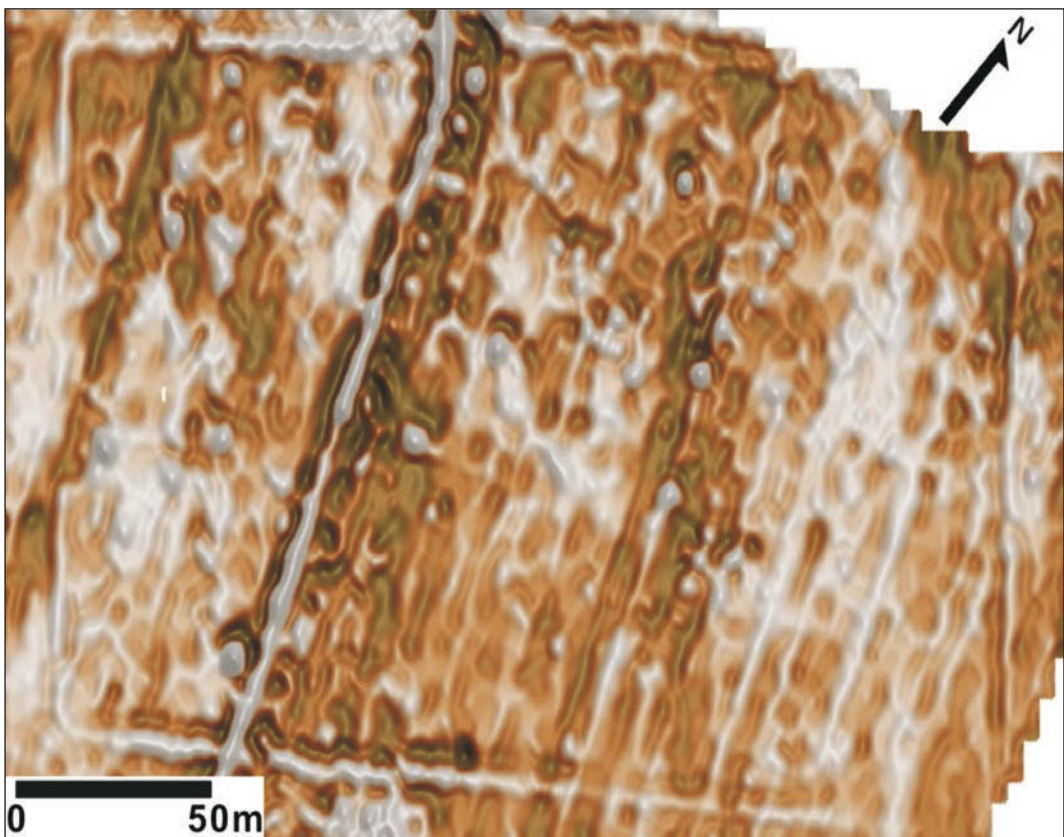

Fig. 21. Závod. Magnetogramm, dynamics ± 7 Nanotesla in 256 colour values from brown to beige.

Fortifications and other features within hill forts

BRANČ, Nitra district

According to the written sources, a medieval settlement was situated on the low sand dune that used to be an island in the past detached from the terrace of the Nitra River by narrow river branch (Ruttkay *et al.* 1995).

Magnetic measurement was realized on the area 1,4 ha with the point density 0,2x0,5 m in the vertical gradient mode. It resulted in a map (Fig. 22) depicting the course of a magnetic vertical gradient anomaly with intensity from -15 to 15 nT/m and width from 3 to 4 m. This anomaly reflects a ditch of circular shape with 45 m diameter and two entrances. Settlement structures datable from the Neolithic through the Bronze Age up to the Middle Ages are present on the site, too.

MAJCICHOV, Nitra district

Two different types of magnetometers were employed by geophysical prospecting in Majcichov, namely Förster Ferex 4.032 DLG from Förster Company (Germany) and caesium magnetometer SMARTMAG SM-4G from Scintrex Company (Ruttkay/Henning/Fotťová/Eyub/Milo/Tirpák 2006).

Below the results obtained by caesium magnetometer are presented. Magnetic measurement was carried out on the area 300x400 m with the point density 0,5x0,2 m. On the map of residual magnetic anomalies (Fig. 19) local anomalies with intensity from -15 to 30 nT were specified that represent archaeological features. A feature that is the best to follow is a fortification system - a rampart of the hillfort and a ditch along its outer face (Kuzma 2007, Fig. 2 in this journal). Magnetic anomalies inside the hill fort reflect present archaeological settlement features. There is only few such features visible on the map what is caused by fluvial layer burying cultural layer, the fact also proved by very few sherds found on the surface.

It is obvious from the map of analytic signal of magnetic field (Fig. 20) that the Slavonic hill fort fortification system - the rampart - was burnt in three fourths of its circumference. Its south-western part that remained untouched by the fire allows following the structure of the rampart on magnetogram. However, the image is negatively influenced by a gasoline with cathode isolation and by electric ferro-concrete poles that caused magnetic values of several hundreds nT.

Roman marching camps

Aerial prospecting played an important role by discovering of the Roman marching camps. More than dozen camps were identified during prospecting and more than half of them was followingly prospected by geophysical methods.

ZÁVOD, Malacky district

The Roman marching camp was detected in the grain field (Blažová/Kuzma/Rajtár 2000). Magnetic measurement was realized on the area 260x210 m with the point density 0,15x0,5 m. From the results a map of residual magnetic anomalies was processed (Fig. 21) where linear anomalies with intensity

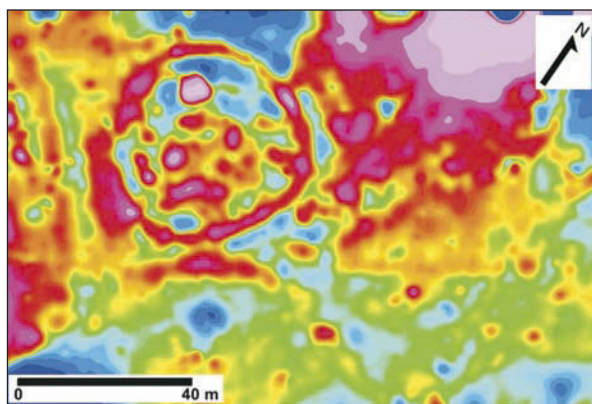

Fig. 22. Branč. Magnetogramm, dynamics +/-15 Nanotesla in 256 colour values from blue to violet.

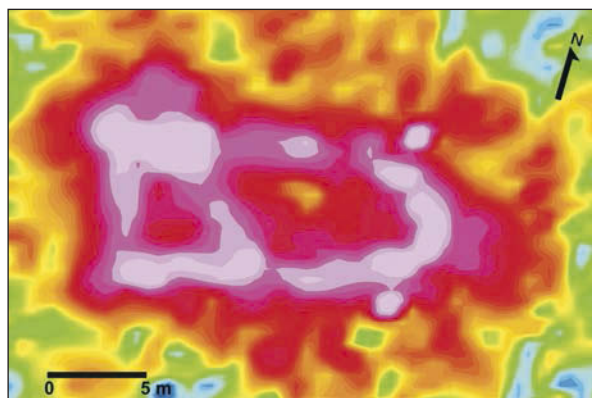

Fig. 23. Poľný Kesov. Map of apparent resistivity, dynamics 50 - 75 Ohm.m in 256 colour values from blue to violet.

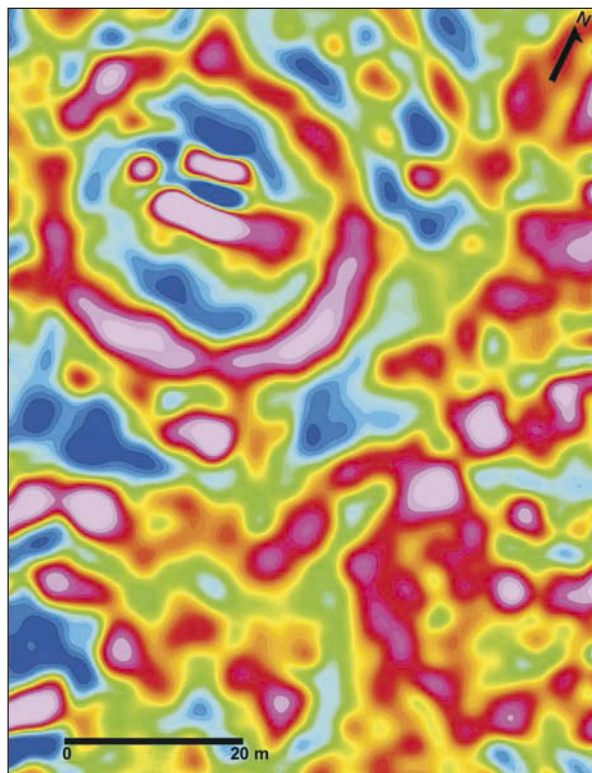

Fig. 24. Poľný Kesov. Magnetogramm, dynamics +/-15 Nanotesla in 256 colour values from blue to violet.

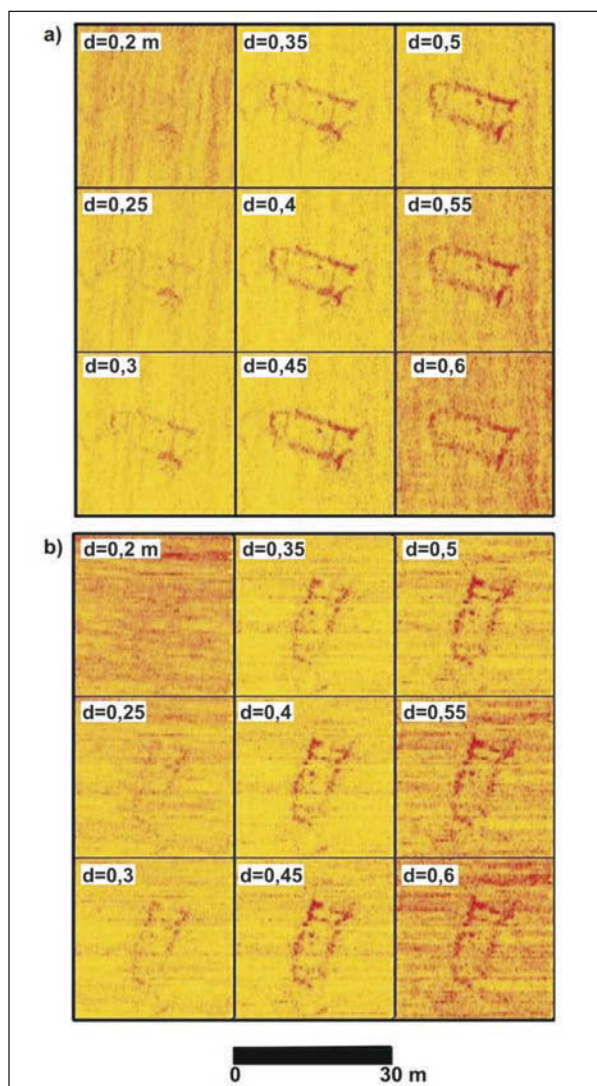

Fig. 25. Poľný Kesov. Selected amplitude time slices from the GPR survey above the main church building.

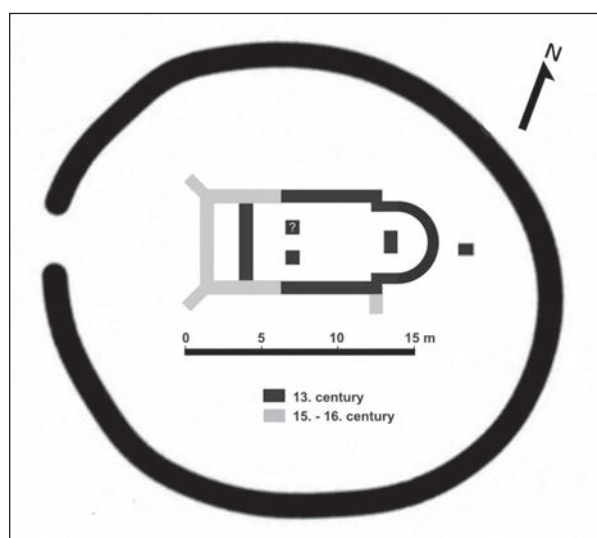

Fig. 26. Reconstruction of church's ground plan on the basis of geophysical measurements.

from -7 to 7 nT indicate the ditches of the marching camp. Measurement allowed precisising the marching camp's ground plan with measurement 170×250 m. Archaeological structures from the Roman Period are present on the site, too.

Architectures

Many of geophysically prospected sites represent sacral objects such as churches, chapels and monasteries. In total 28 churches, 3 chapels and 8 monasteries were prospected. Prospecting was aimed at completing the knowledge about the ground plans of buried structures outside the standing buildings, localisation of architectures below the floors of standing buildings, their interior ground plans, identification of building phases and preservation condition and building development of the sacral architectures.

POLNÝ KESOV, Nitra district

Location of a deserted church was detected by aerial prospecting in 2000 (Kuzma/Blažová/Bartík/Rajtár 2001; Kuzma 2007, Fig. 43 in this journal). In the course of more extensive aerial prospecting knowledge about location and extent of the deserted medieval village were obtained too (Kuzma/Samuel/Tirpák 2004).

Consequently, with the aim to investigate in non-destructive way the deserted architectures, a geoelectric resistivity profiling, magnetic and georadar measurements were carried out on the site.

As seen on isoohm map (Fig. 23), the local resistivity anomalies reached values from 50 to 75 Ohm.m. The resistivity values over 65 Ohm.m show increased ground apparent resistivity. This kind of increased local resistivity anomalies indicate the presence of the foundation remains of a sacral building with measurements 16×7 m with recognizable supporting pillars foundations by the western wall of the church nave.

In the map of residual magnetic anomalies (Fig. 24) a circular anomaly with intensity from -7 to 7 nT can be specified that indicates the ditch of oval shape around the church. Supposedly, the ditch originated at the end of the 19th century and delimited the area of the church. Isometric anomalies with intensity from -3 to 5 nT indicate archaeological settlement structures.

Results of georadar measurements with 500 MHz antenna refined and completed the knowledge about the building development of the sacral object (Fig. 25). Church foundations were identified in the depth 20-150 cm and they are ca. 80-100 cm wide. Georadar measurement allowed defining the eastern part of the church's ground plan, of the apse in the shape of prolonged semicircle and of a feature with measurements 6×7 m situated north-east of the church sanctuary (Samuel/Tirpák 2007). Geophysical measurements allowed reconstructing the building phases of the deserted architecture and of its immediate surrounding (Fig. 26).

RADOLA, Kysucké Nové Mesto district

Geophysical measurement aimed at localising the architectural remains from the 13th century was carried out on the site of the deserted church that was archaeologically excavated in 1956. According to the results of archaeological excavation, the foundations of the stone-

built sacral structure consisting of 9,8×9,1 m large nave and 6,4×5,1 m large sanctuary were unearthed. A sacristy with measurements 5×4,1 m was uncovered on the sanctuary's northern side. The church had NW - SE orientation (Petrovský-Šichman 1963).

To verify these results, the resistivity method with twin configuration of electrodes and the dipole electromagnetic profiling method were used on the site. An area of 300 m² with the point density 1×1 m was geophysically prospected. Anomalies with intensity from 230 to 420 Ohm.m are visible on the resistivity map (Fig. 27) where anomalies with the values over 300 Ohm.m indicate the architectural remains of excavated church. On the isomilisiemensmeter map (Fig. 28) the anomalies vary from 7 to 18 mS/m and anomalies below 10 mS/m indicate the architectural remains of excavated church. Comparison of the results of both applied methods shows the importance of employment of different geophysical approaches that allows obtaining of more complex information about the preservation of the church's foundations.

Conclusions

Non-destructive methods including geophysical prospecting enlarge considerably the database and knowledge about the past settlement of the territory of Slovakia. In the course of the period of employing the geophysical prospecting in archaeology, its undoubted advantages and effectiveness by localising the archaeological sites, by acquiring basic data about their extent, structure and location in the past landscape were established. These data have reliability

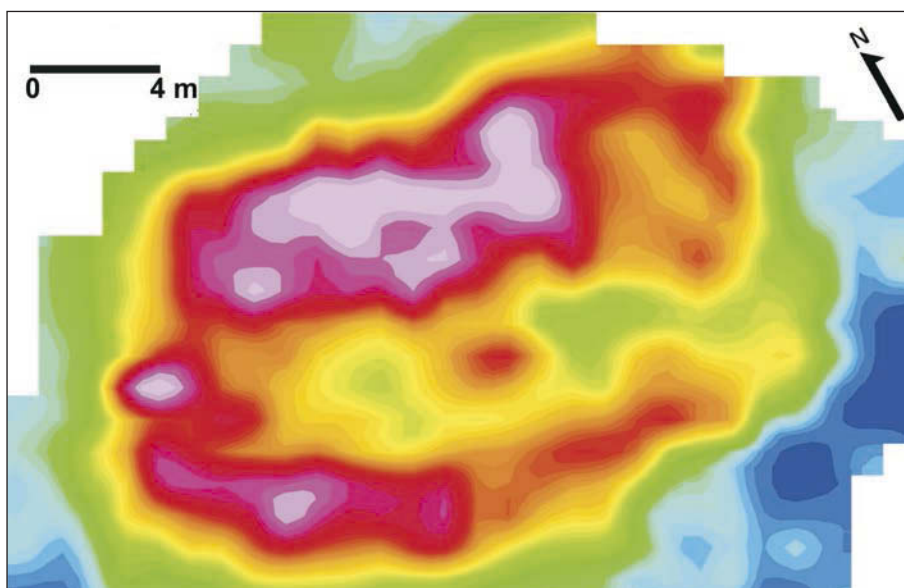

Fig. 27. Radola. Map of apparent resistivity, dynamics 80-300 Ohm.m in 256 colour values from blue to violet.

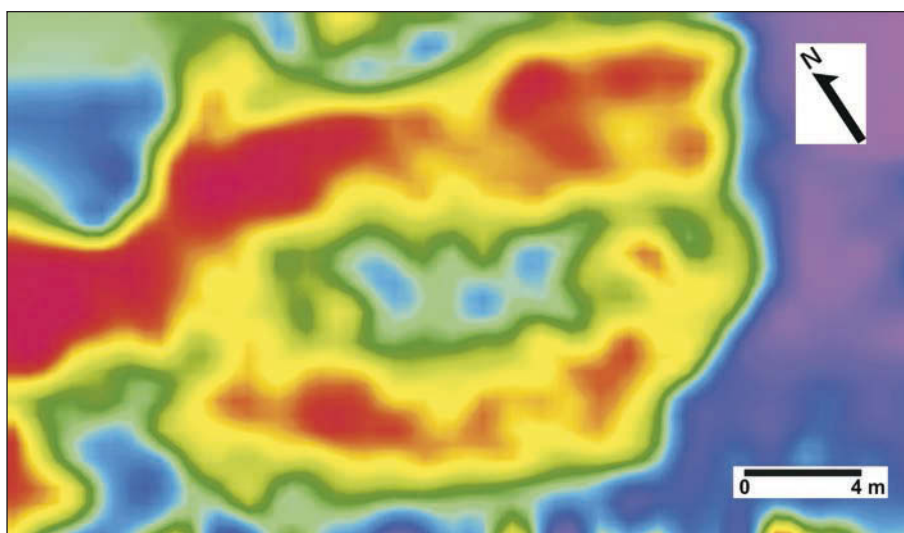

Fig. 28. Radola. Map of apparent conductivity, dynamics 7-18 mS/m in 256 colour values from red to violet.

and they also represent a valuable base for the primary evidence of archaeological sites and their protection. Complex processing of geophysical results along with the geographic, geological, pedological and other data offers new insights on the development of individual sites and of the whole landscape. Geophysical data gained in importance thanks to their irreplaceability and complementarity in the relation with other field methods in archaeology.

REFERENCES

- Blažová/Kuzma/Rajtár 1998* E. Blažová/I. Kuzma/J. Rajtár: Nové výsledky leteckej prospekcie na Slovensku. AVANS 1996, 1998, 32-35.
- Blažová/Kuzma/Rajtár 2000* E. Blažová/I. Kuzma/J. Rajtár: Letecká prospekcia na Slovensku. AVANS 1998, 2000, 36-40.
- Hanzelyová/Kuzma/Rajtár 1995* E. Hanzelyová/I. Kuzma/J. Rajtár: Letecká prospekcia na juhozápadnom Slovensku. AVANS 1993, 1995, 54-58.
- Hanzelyová/Kuzma/Rajtár 1996* E. Hanzelyová/I. Kuzma/J. Rajtár: Letecká prospekcia v archeológii na Slovensku. AR 48, 1996, 194-211, 275-278.
- Javorský 1986* F. Javorský: Záchranne výskumy a prieskumy výskumnej expedície Spiš Archeologického ústavu SAV. In: AVANS 1985, 1986, 110-134.
- Kuzma 1992* I. Kuzma 1992: Výsledky leteckej prospekcie na juhozápadnom Slovensku. AVANS 1990, 1992, 62-64.
- Kuzma 1998* I. Kuzma: Kruhové priekopové útvary na Slovensku (súčasný stav). In.: Otázky neolitu a eneolitu našich zemí. Turnov-Hradec Králové 1998, 94-102.
- Kuzma 1999* I. Kuzma: Kruhovitá priekopa v Branči. In: Otázky neolitu a eneolitu našich krajín. 1998, 1999, 133-142.
- Kuzma 2002* I. Kuzma: Rondel v Prašníku. In: AVANS 2001, 2002, 95-96.
- Kuzma 2005* I. Kuzma: Kruhové priekopové útvary na Slovensku - aktuálny stav. In: Otázky neolitu a eneolitu našich zemí. Nitra 2004, 185-223.
- Kuzma 2007* I. Kuzma/J. Tirpák: Rondel v Bajtave, okr. Nové Zámky. In: AVANS 2004, 2007, 137-138.
- Kuzma/Bartík 2004* I. Kuzma/M. Bartík: Letecká prospekcia na juhozápadnom Slovensku. AVANS 2003, 2004, 108-116.
- Kuzma/Bartík/Rajtár 2002* I. Kuzma/M. Bartík/J. Rajtár: Letecká prospekcia na Slovensku. AVANS 2001, 2002, 101-108.
- Kuzma/Blažová/Bartík/Rajtár 2001* I. Kuzma/E. Blažová/M. Bartík/J. Rajtár: Letecká prospekcia na Slovensku, AVANS 2000, 2001, 112-138.
- Kuzma/Hanzelyová/ Rajtár/ Tirpák 1996* I. Kuzma/E. Hanzelyová/J. Rajtár/J. Tirpák: New Results in Aerial Archaeology in Slovakia: Experience with Reconnaissance, Geophysical Measurement and Follow-up Excavations. Archaeological Prospection, Vol. 3, 71-79.
- Kuzma/Samuel/Tirpák 2004* I. Kuzma/M. Samuel/J. Tirpák: Niektoré výsledky leteckej a geofyzikálnej prospekcie v roku 2002 a 2003 v AÚ SAV Nitra. In: Ve službách archeologie, V. Brno 2004, 39-41.
- Kuzma/Tirpák 2001a* I. Kuzma/J. Tirpák: Štvornásobný rondel v Cíferi, okr. Trnava. In: Ve službách archeologie III. Brno 2001, 203-210.
- Kuzma/Tirpák 2001b* I. Kuzma/J. Tirpák: Triple circle ditch system in Golianovo, district Nitra, Slovakia. In: Archaeological prospection. Wien 2001, 138-141.
- Kuzma/Tirpák 2003* I. Kuzma/J. Tirpák: Rondel v Žitavciach. AVANS 2001, 2003, 78-79.
- Kuzma/Tirpák 2004a* I. Kuzma/J. Tirpák: Rondel v Nových Sadoch. In: AVANS 2003, 2004, 123-124.
- Kuzma/Tirpák 2004b* I. Kuzma/J. Tirpák: Rondel v Zemianskych Sadoch. In: AVANS 2003, 2004, 124-125.
- Kuzma/Tirpák 2004c* I. Kuzma/J. Tirpák: Kreisgrabenanlagen in Podhorany, Bez. Nitra. In: K počtě Vladimíru Podborskému. MU Brno 2004, 101-112.
- Kuzma/Tirpák 2006a* I. Kuzma: Aerial archaeology in Slovakia. Štud. zvesti AÚ SAV 41, 2007, 11-39.
- Kuzma/Tirpák 2006b* I. Kuzma/J. Tirpák: Rondel v Hosťovciach, okr. Zlaté Moravce. In: AVANS 2004, 2006, 138-139.
- Kuzma/Tirpák 2006c* I. Kuzma/J. Tirpák: Rondel v Prašníku. In: AVANS 2004, 2006, 139-140.
- Němejcová/Pavůvková 1997* V. Němejcová/Pavůvková: Kreisgrabenanlage der Lengyel-Kultur in Ružindol-Borová. Studia Archaeologica et Medievalia, Tomus III, Facultas Philosophica Universitatis Comenianae Bratislavensis, Bratislava 1997.
- Petrovský-Šichman 1963* A. Petrovský-Šichman: Výskum zaniknutého stredovekého kostola v Radole. Štud. zvesti AÚ SAV 11, 1963, 229-265.
- Ruttkay/Slivka 1985* A. Ruttkay/M. Slivka: Cirkevné inštitúcie a ich úloha v sídliskovom a hospodárskom vývoji Slovenska. In: Archaeologica Historica 10, 333-356.
- Ruttkay et al. 1995* M. Ruttkay et al.: Archeológia a ropa. Nitra 1995, 30-35.

*Ruttkay/Henning/Fottová/Eyub/
Milo/Tirpák 2006*

M. Ruttkay/J. Henning/E. Fottová/E. Eyub/P. Milo/J. Tirpák: Hradiská v Majcichove a Pobedime. Geofyzikálny prieskum a archeologický výskum včasnostredovekých opevnených areálov na juhozápadnom Slovensku. In: Ve službách archeologie VII, Brno 2006, 93-112.

Samuel/Hunka/Tirpák 2004

M. Samuel/J. Hunka/J. Tirpák: 2004: Zaniknutý stredoveký kostol v Poľnom Kesove. Lokalizácia, prieskum a historické súvislosti, In: Zborník na počesť Dariny Bialekovej. Nitra 2004, 329-334.

Samuel/Tirpák 2007

M. Samuel/J. Tirpák: Nové poznatky o zaniknutom stredovekom kostole v Poľnom Kesove. In: Ve službách archeologie 1/07, Brno 2007, 199-204.

Tirpák 1994

J. Tirpák: Výsledky geofyzikálnych meraní pri precizovaní základov stredovekých sakrálnych stavieb na Slovensku. In: Dejiny a kultúra rehoľných komunít na Slovensku. Trnava 1994, 92-113.

Tirpák 1997

J. Tirpák: Geophysikalische Messungen Urzeitlicher Rondelle, In: Němejcová-Pavúková, V. 1997: Kreisgrabenanlage der Lengyel-Kultur in Ružindol-Borová. *Studia Archaeologica et Medievalia*, Tomus III, Bratislava 1997, 153-156.

Ján Tirpák

Archaeological institute of SAS
Akademická 2
949 21 Nitra, Slovakia
jan.tirpak@savba.sk

THE QUALITY OF DTM WITH RESPECT TO THE USED SOFTWARE AND DEFINITION OF INPUT DATA

Elena Blažová

Key words: digital terrain model, triangulated irregular, GIS software, interpolation

Using modern technological approaches, the topographic mapping and survey of archaeological sites, manifesting by artificial changes of the relief, offer very demonstrative view of the landscape.



Fig. 1. Aerial view of the site. Photo by I. Kuzma, Institute of Archaeology SAS.

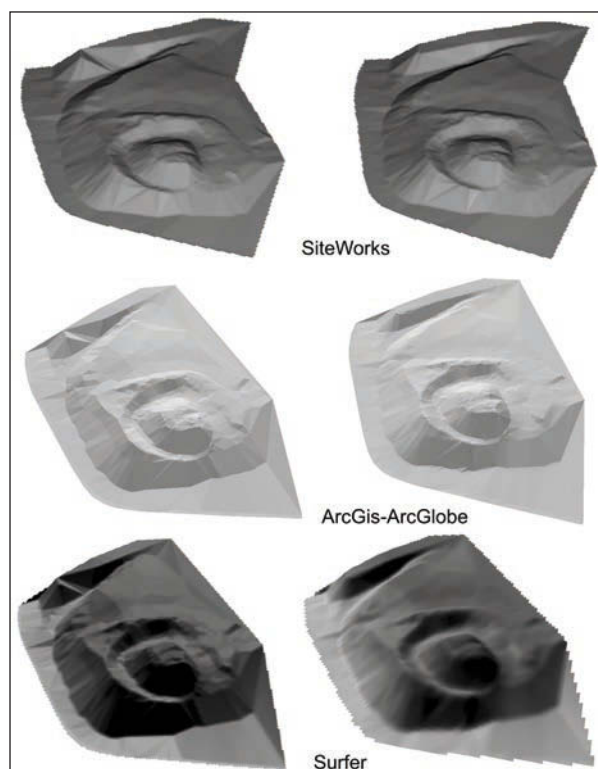

Fig. 2. DTM examples without and with defined terrain lines processed in 3 softwares.

Such, in regard of the extent of the site and its vegetation sometimes rather minor relief changes, can become more expressive after data collecting and model creation.

Digital terrain model can be simply defined as a result of interpolation of a set of spatially defined points.

Paper presents the digital terrain model creation for archaeological sites and compares the models processed from the identical data sets with the help of different softwares. To be able to create the DTM of a good quality, it is inevitable to assign specific character to data already by their collecting. Unlike data collecting in natural terrain, lining-up of single elements is very important by mapping the archaeological sites as they represent the determining characteristics by creation of TIN (triangulated irregular network).

A module for DTM creation is a usual accessory by majority of available GIS softwares. A combination of proper data collecting and suitable software is a precondition for creation of the most realistic model of an archaeological site.

For archaeological site's DTM it is more convenient to use TIN method as the topologic relations between the points are expressed explicitly (triangular network connecting neighbouring points) that becomes evident by complicated processing and presentation. It is also possible to create a DTM from data in regular network, i.e. raster or grid, where, however, topologic relations are expressed implicitly. In regard of processing optimization, this method is rather fitting for processing the topographic relief of larger units.

Further step is interpolation and choice of optimal spatial resolution of resultant rasters. It is obvious that apart from hydrology, meteorology, modelling of geomorphological processes etc., the DTM found its position also in archaeological sites prospecting.

As a case study, a DTM creation from Kamenín site is presented.

Figured DTMs are based on the identical data and processed in three softwares - Site Works (Microstation), ArcGis (Esri) and Surfer (GoldenSoftware). On the right side the results regarding the point characteristics - lines - and on the left side the results not regarding the point characteristics are shown. The models are presented in the grey scale without implementing the colour scale or other overlays for better comparison.

Elena Blažová
Archaeological institute of SAS
Akademická 2
949 21 Nitra, Slovakia
nrauhandz@savba.sk

ARCHAEOLOGICAL RESEARCH AND GEOPHYSICAL EXPLORATION AT THE EARLY MEDIEVAL FORTIFIED SETTLEMENT IN MAJCICHOV AND OTHER SITES

Joachim Henning - Matej Ruttkay - Eyub Eyub - Peter Bednár - Eva Fotová - Peter Milo - Jan Tirpák -
Monika Kopčková - Klaudia Daňová

Key words: Majcichov, Slavic fortified settlement, magnetometry, excavations

More detailed archaeological exploration and excavation at several early medieval fortified settlements in western Slovakia were realized in years 2004-2006 within the common project called Summer School of Archaeology (Archaeological Institute of the Slovak Academy of Sciences in Nitra - the project manager Matej Ruttkay - and the J. W. Goethe Universität Frankfurt am Mein - the project manager prof. Joachim Henning) and in the framework of the project „Protection and Rescue of Archaeological and Historical Monuments as an Integral Part of European Cultural Heritage“. The impulse for the rise of these projects were also first new results of aerial photography that in



Fig. 1. Majcichov, distr. of Trnava. The timber grate found under the chamber and the front stone screen of the mound.

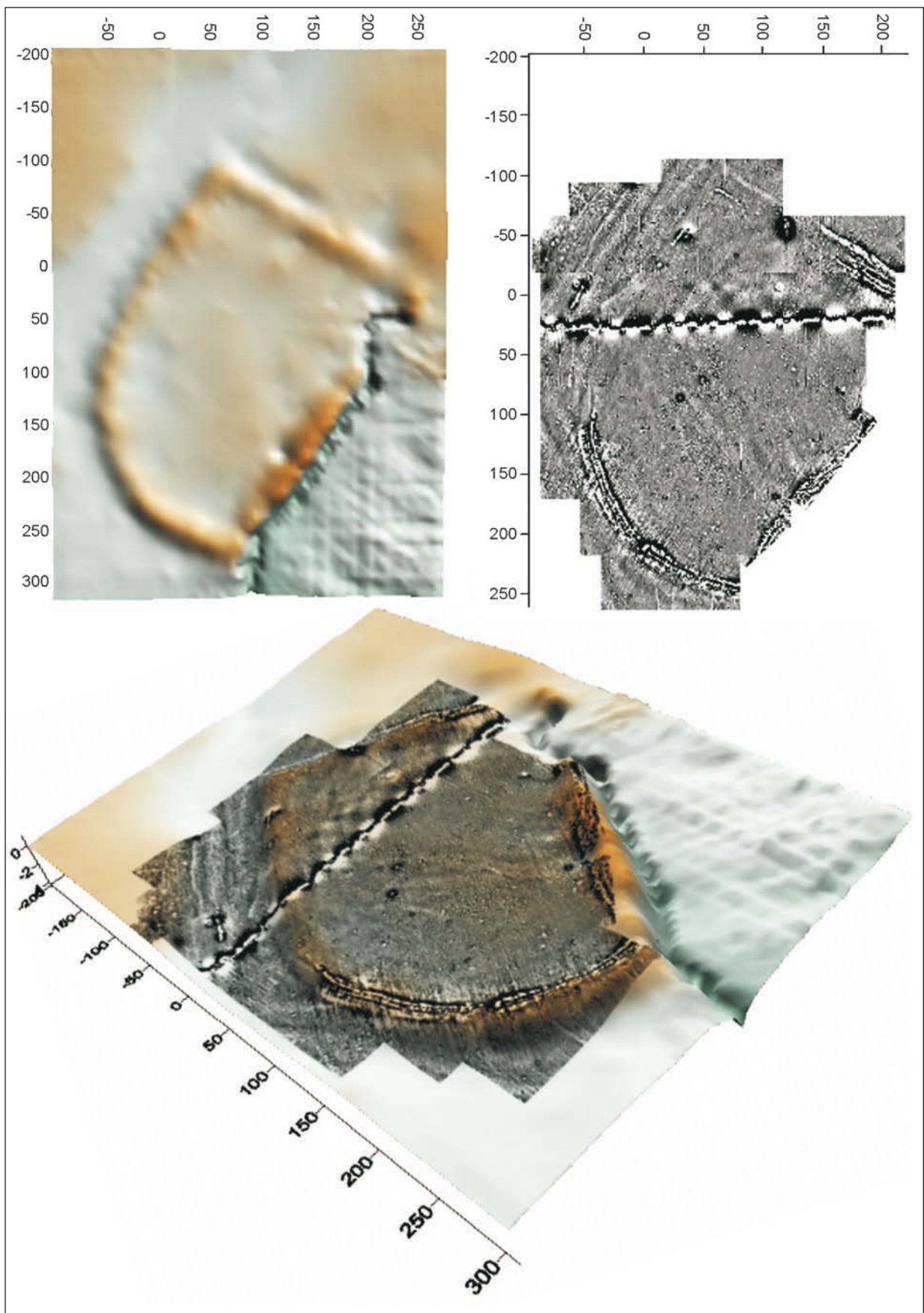

Fig. 2. Magnetic gradiometry survey of Majcichov.

several cases brought signs of changes in original ground plans of buildings or a presence of new fortifying structures. The project task was also to educate archaeological youth within the summer school of archaeology as well as to obtain dendrological samples, which consequently could be evaluated in German laboratories.

Special attention was paid to three lowland finding places - inundation fortified settlements in Majcichov, Pobedim und Bíňa. Majcichov and Pobedim were completely geophysical measured and Bíňa only partly. In Majcichov and Bíňa also probing was done that was aimed in finding-out the site state, defining its construction characteristics and also in précising its dating (the best way by dendro-chronology).

Two independent magnetometric measurements were carried out in Majcichov, the first with caesium magnetometer SMARTMAG SM 4G (Scintrex, Canada) by J. Tirpák and the second one with caesium Forster Ferex 4.032 DLG (Foerster Instruments Incorporated, USA) by E. Eyub and P. Milo. Using these apparatuses we can compare the measured results, which differ in certain details.

As far as the geophysics is concerned, the measurements from the fortified settlements brought relatively different results. Whereas the site in Majcichov is outstanding mainly by its well observable structure of fortification, in which also detailed construction elements are visible at some point, in Pobedim such observations were not possible. In spite of the fact that the mound in Pobedim was also destroyed by fire, it does not show remarkably different magnetic values toward its neighbourhood and its line is only less better observable than non-burnt less identifiable segment of the mound in Majcichov.

The other and basic different in results of geophysical measurements is the presence of archaeological objects inside the fortified settlement area and out of it as well. In Majcichov the archaeological objects on the site area were measured only rarely, however, in Pobedim they are documented almost on the whole acropolis as well as on the big area of the settlement in front. The absence of magnetic anomalies within the fortified settlement in Majcichov cannot automatically indicate the absence of archaeological objects. It probably is a consequence of inundation layer covering the inner area of the settlement. The archaeological research alone documented a system of the fortification construction - a mound and a timber chamber construction with foundation grate.

Results of geophysical measurements between middle and outer rampart in Bíňa pointed out to the presence of earth-houses, but also to other anomalies. At each of these sites, samples for 14C analysis were taken directly from the constructions.

Results of the three stage of the project solving prove that a pointed research can give constant new information on early medieval fortified sites. Remarkable precision has been obtained first of all in the question of knowing of the fortifying construction in Majcichov, in finding of another settlement agglomerations.

Joachim Henning
Eyub Eyub
Johann Wolfgang-Goethe Universität
Seminar für Vor- und Frühgeschichte
Grüneburgplatz 1
D-603 23 Frankfurt am Main
j.henning@em.uni-frankfurt.de
eyub @em.uni-frankfurt.de

Peter Milo
Masarykova univerzita - Filozofická fakulta
Ústav archeologie a muzeologie
Arna Nováka 1
602 00 Brno, Czech Republic
milo@post.sk

Matej Ruttkay
Peter Bednár
Eva Fottová
Jan Tirpák
Monika Kopčková
Klaudia Daňová
Archaeological institute of SAS
Akademická 2
949 21 Nitra, Slovakia
matej.ruttkay@savba.sk
peter.bednar@savba.sk
eva.fottova@savba.sk
jan.tirpak@savba.sk
monika.kopcekova@savba.sk
klaudia.v@atlas.sk

GEOMAGNETIC PROSPECTING OF THE HILL-FORT OF POBEDIM (SLOVAKIA)

Joachim Henning - Eyub Eyub – Matej Ruttkay

Key words: Pobedim, slavic hill fort, magnetometry

The hill-fort of Pobedim, known for a long time, was fully geo-magnetically prospected by three consecutive measuring campaigns (2004, 2005, 2006). With together 23 hectares of prospected surface is Pobedim the largest geo-magnetically researched fort area in central Europe.

After the years-lasting excavations, generously focused on the fortification-structures, an exact picture of the internal-structure of the area could be eventually gained. The geomagnetic prospecting brought many information and interesting results according to this structure. The geomagnetic picture provides us not only with the view of the whole location, but also with lots of detailed information. Besides many little-spacious anomalies, which have clearly definable frontiers, also a lot of linear structures along the fortification line were exactly documented. In spite of the high number of the obviously anthropogenic ground movements enables the geomagnetic picture to identify many of the detectable single structures such as pole-tracks and holes. At many places, parts of the wall constructions with fire-tracks were found. They were the right locations for targeted excavations in order to gain charcoal. Thereby there is a chance for an exact dendrochronologic dating. The last measuring discovered till now unknown parts of the fortification. This new-appearance could have been probably a previous construction, that means an older fortification area.

The complexity of the magnetization-process reflects the existing archeological problems. The geomagnetic prospecting has shown on the example of Pobedim, what a large spectrum of questions could be handled.

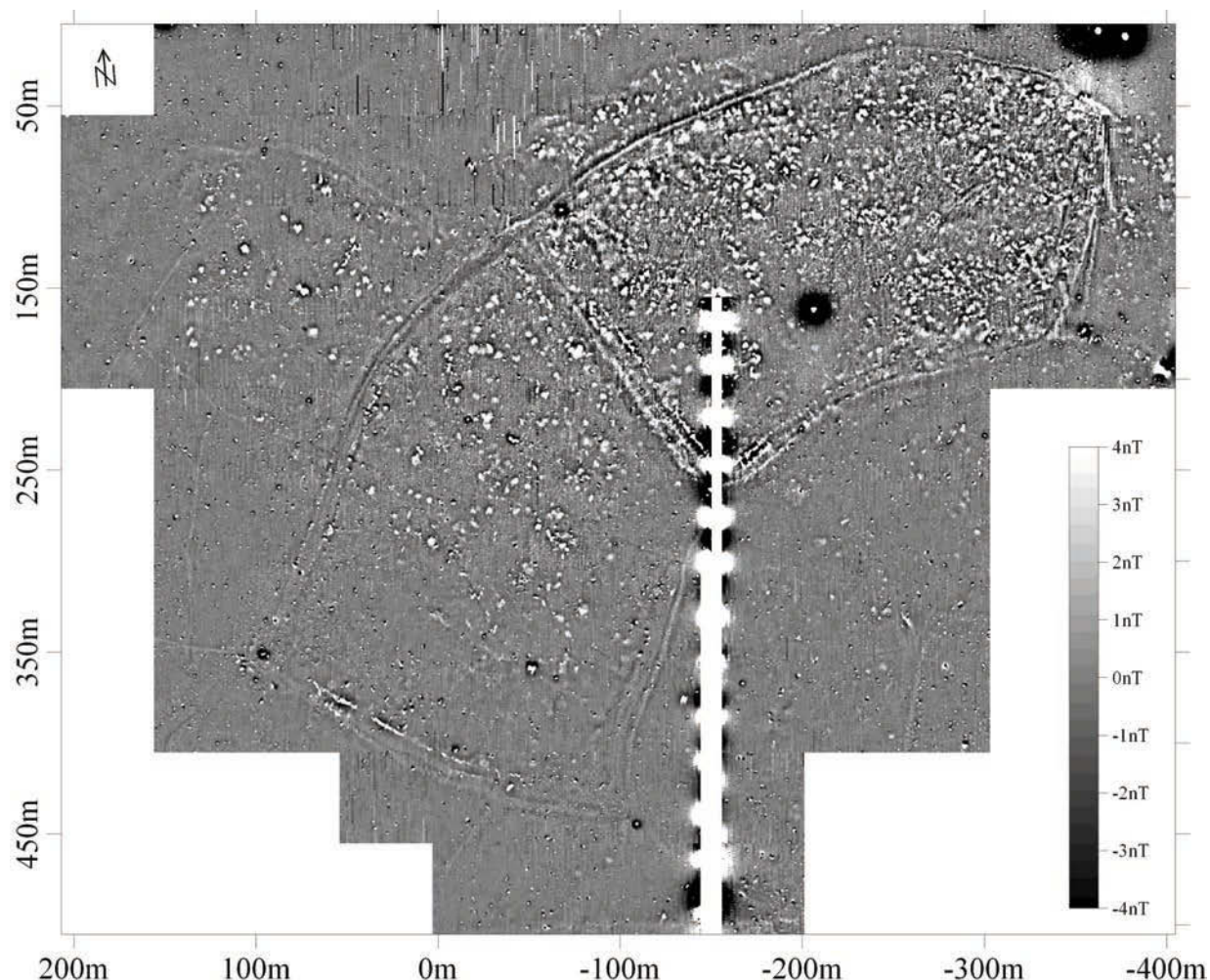

Fig. 1. Magnetic gradiometry survey of Pobedim.

Joachim Henning
 Eyub Eyub
 Johann Wolfgang-Goethe Universität
 Seminar für Vor- und Frühgeschichte
 Grüneburgplatz 1
 D-603 23 Frankfurt am Main
 j.henning@em.uni-frankfurt.de
 eyub@em.uni-frankfurt.de

Matej Ruttkay
 Archaeological institute of SAS
 Akademická 2
 949 21 Nitra, Slovakia
 matej.ruttkay@savba.sk

ANALYSIS OF ROUNDEL VISIBILITY IN GIS ENVIRONMENT

Ivan Kuzma - Tibor Lieskovský

Key words: Prašník, Kočín, roundel, GIS, visibility

Analyses of spatial relations between prehistoric circular enclosures (roundels) and the countryside, and analyses of mutual spatial relations between the roundels may help clarify their origins and function. The analysis of mutual visibility is one of such analyses. Visibility could have been an important factor for selection of a site. It had the pragmatic defensive function, for it was necessary to strategically choose places with the largest possible view and thus control the territory. Mutual visibility of roundels allowed to signal possible attacks. Visibility of roundels could have played an important role also with regard to their functions as centres of cult or power, since sites were sometimes chosen symbolically on elevated areas dominating the countryside (Dreslerová 1996). Visibility was also a key factor in those cases when roundels were built for the purposes of astronomy.

Visibility analyses are currently done in Geographic Information Systems (GIS) environments, which are equipped with relevant analytical instruments (Viewshed, or Line of Sight). The basis for the analysis is a digital altitude

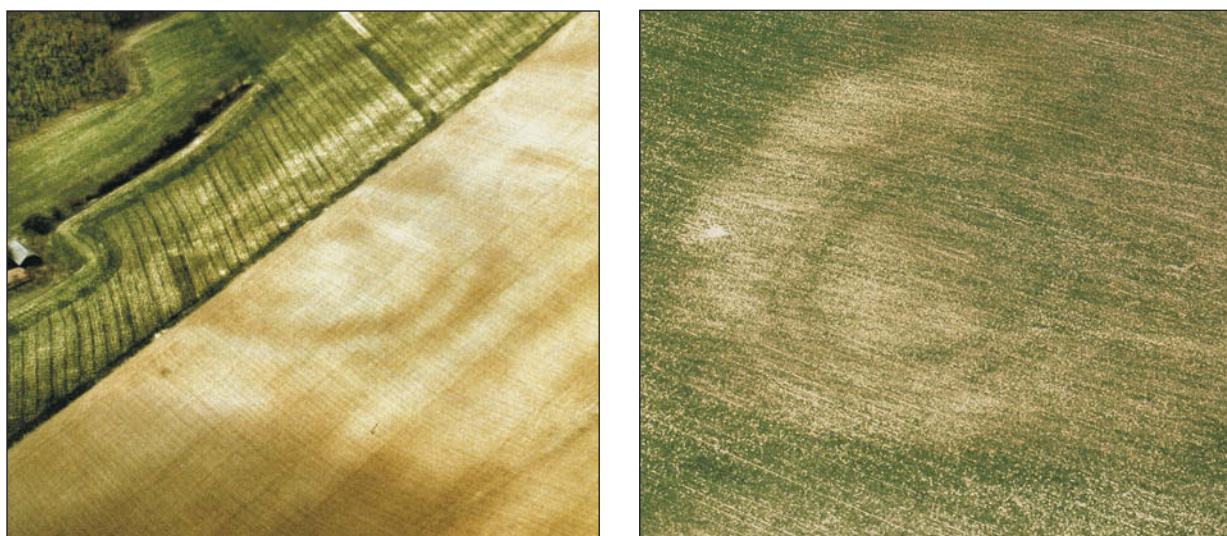

Fig. 1. a - Prašník, oblique photograph 6 May 2001; b - Kočín, oblique photograph 9 June 2004.

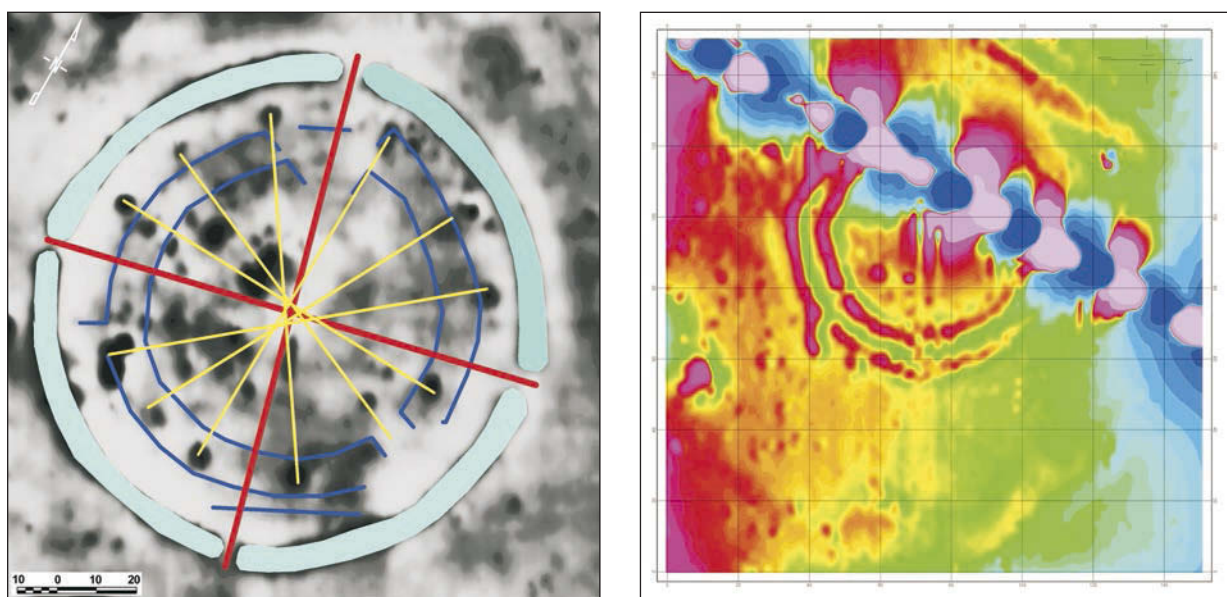

Fig. 2. a - Magnetic map of Prašník enclosure; b - Magnetic map of Kočín enclosure.

model which is most frequently in the grid form. At this point it is important to specify terminological difference between the digital terrain model (DTM) and the digital relief model (DRM):

- *Digital relief model DRM* is a statistical representation of the continual Earth's surface through a large number of selected points with known coordinates x , y and z in a random grid system (Rapant 2005). It defines the primary Earth's surface and excludes anthropogenic and natural elements such as buildings and vegetation.

- *Digital terrain model DTM* represents the top part of the surface including buildings and vegetation. It expresses not only Earth's surface but also the surface of all objects on it (roofs, treetops etc.). The model can be created from entry data acquired by photogrammetry, LIDAR data or similar.

In most cases DRM is used for spatial analyses because anthropogenic and natural elements (woods or lines of trees) cause problems which must be reduced (e.g. analysis of possible watercourses). In contrast, DTM is used for visibility analyses as it takes into account natural and anthropogenic obstructions which might prevent the view (e.g. vegetation). However, usually only DRM is available.

Natural obstructions are generally one of the biggest problems in visibility modelling. This was even more so in the past. If we know the current position of vegetation and at least its approximate height we are able to model its

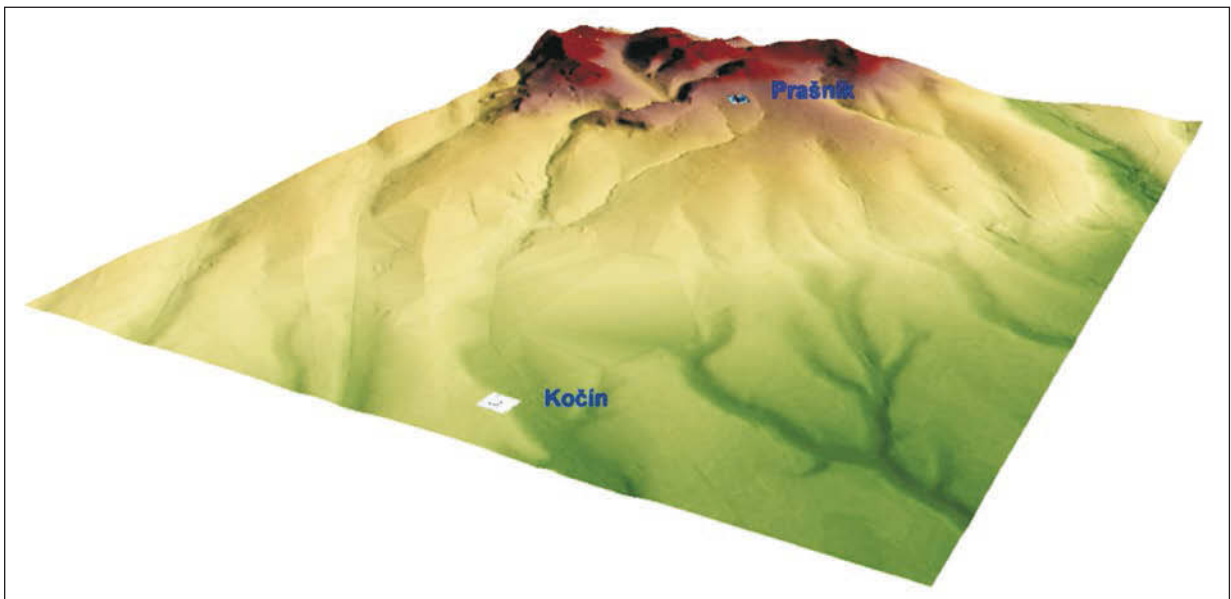

Fig. 3. Digital relief model.

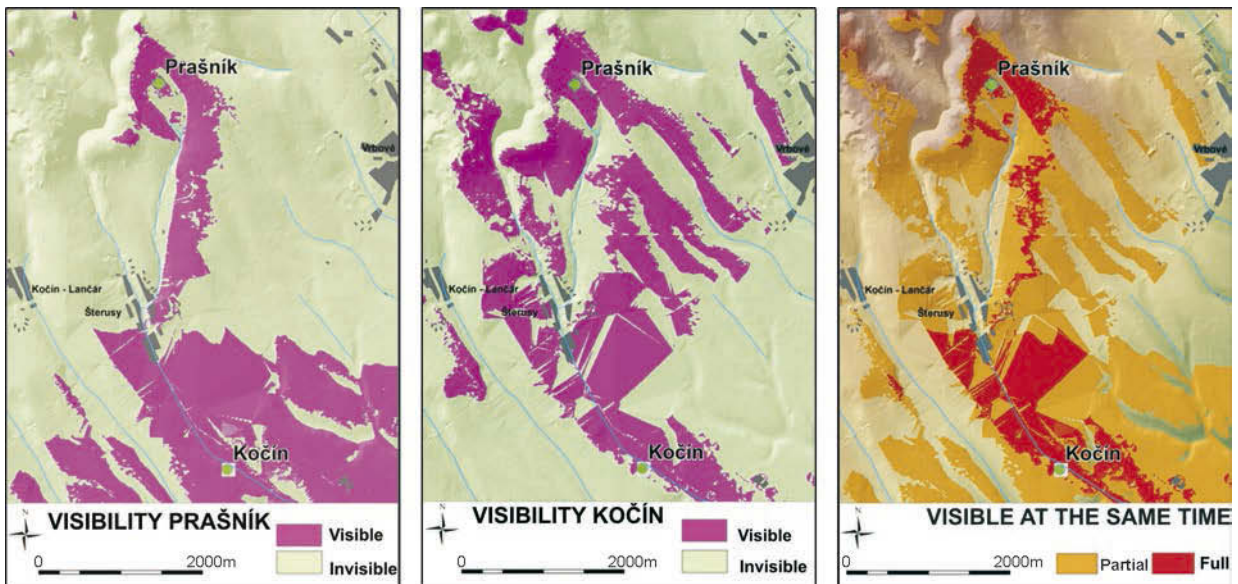

Fig. 4. Process of summing up visibility layers.

course. This is also the case with buildings. The problem arises, however, when the structure of the countryside in the past is being determined. It can partially be reconstructed on the basis of historic maps (e.g. 1st. and 2nd Ordnance Survey) but that is only possible approximately to the Middle Ages. However, we assume there was more vegetation in the prehistoric ages than there is today. Therefore we suppose that where it was necessary and purposeful, there might have existed aisles between two points or, in case of hillforts, the hilltops might have been depleted of vegetation, or artificially elevated areas might have been built (watch towers).

The analysis is done on the principle that from a particular point (the grid cell) the visibility of all other cells is observed. This point approximation has its limitations, for an archaeological site rarely represents only one point (like with e.g. a watch tower). Objects are usually of area character, which means that what is visible is always a particular part or that different parts of the area are observable from different places. There is also certain risk in localising a site (or an object) as a point. If localised for example directly below the hilltop, the object might be hidden in phantom obscuration. Such problems can be partially reduced by adding the height of the observer or the aim to the surface (so-called offset).

We have analysed mutual visibility of Prašník and Kočín circular enclosures. These roundels were identified by aerial prospection. Subsequently they were geophysically measured and their position was determined by GPS.

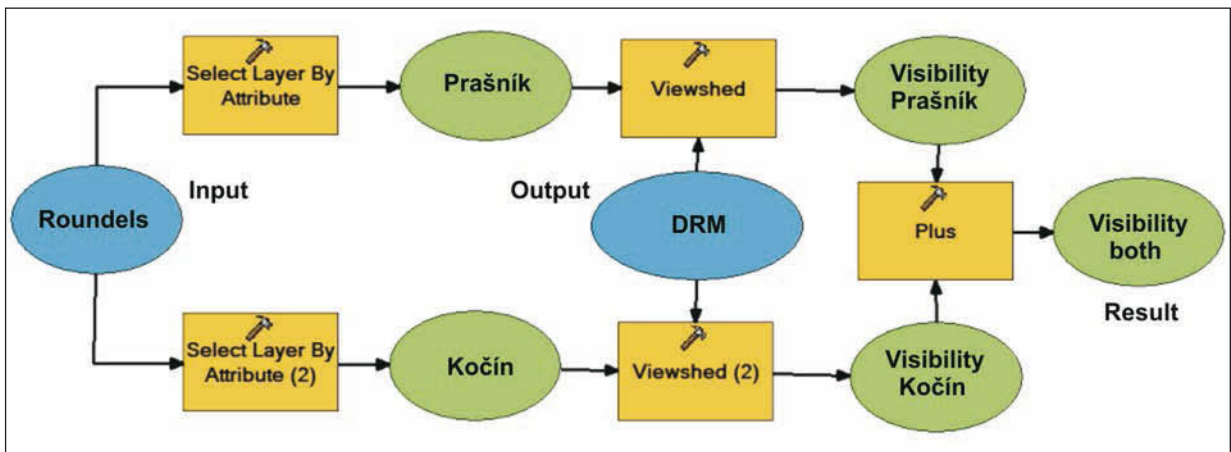

Fig. 5. Geoprocessing model of mutual visibility analysis.

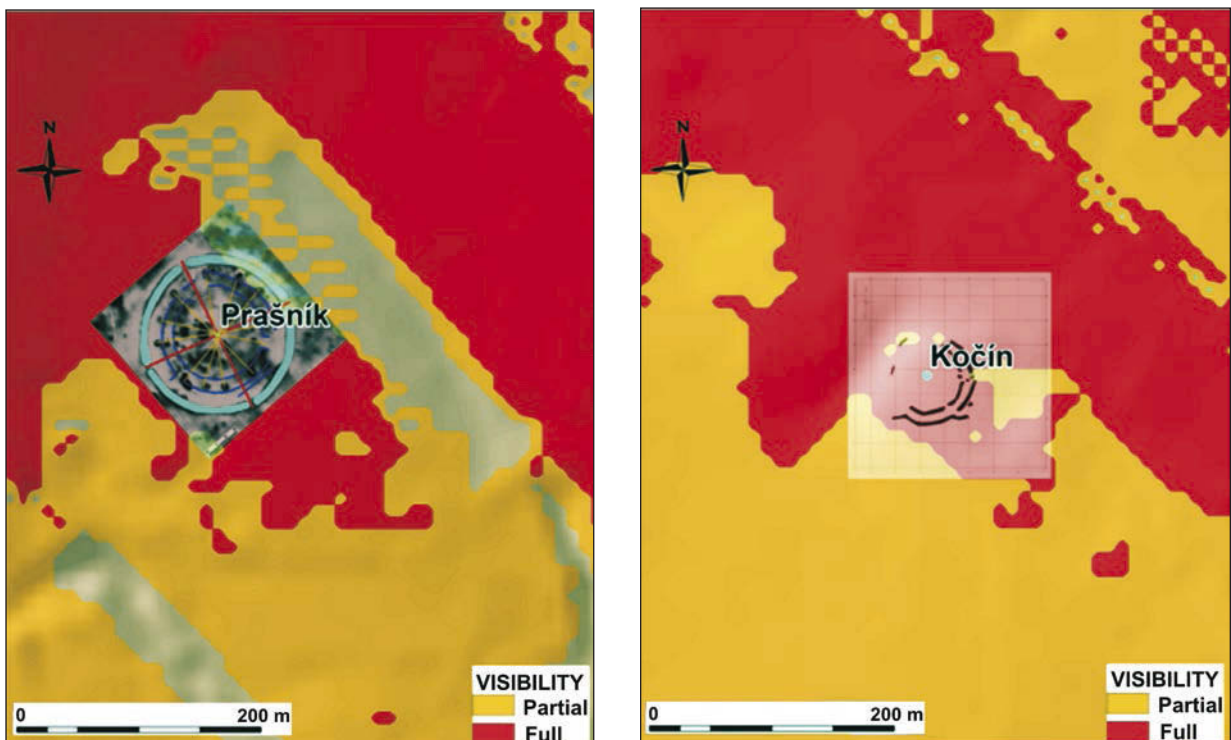

Fig. 6. Visibility of the surrounding area of the rondels.

Prašník

The Prašník roundel was detected on a vertical photograph taken on 24 August 1985 (Kuzma 2002, 95). It was confirmed as a soil mark (Fig. 1a) by oblique photographing on 6 May 2001 (Kuzma/Bartík/Rajtár 2003).

The roundel is situated above Vrbové town in a slight valley. This position allows a view from the enclosure in SSE to SSW direction but in a relatively limited angle of 80-90 grades. It lies 310-322 m above sea level on the slope orientated in south-east direction; the distance between its highest and lowest points is 12 m.

Field walking on the rondel area has given small amount of material, which dates it to the first phase of Lengyel Culture.

The magnetometric measurements confirmed a ditch with diameter of 130 m with four simple entrances 3 to 6 m wide and orientated in north-south and east-west directions (Fig. 2a).

Further anomalies are inside the rondel. They follow the ditch in two lines in the distance of 11 and 19 m. The diameter of the first one is 90 m, that of the second one is 70 m; they are 1 m wide. The inner line has two interruptions: one is wing-shaped, 7 m long and directed outwards; the other one has 8 m long wings directed inwards, the width between them is 10 m on southern side and 13 m on northern side. The outer line has four interruptions with width of 28 m on northern and south-western side, and 6 m on eastern side. The wings on the northern side are orientated inwards, on the eastern side outwards. The interruptions of both of the lines only follow the entrances of the main ditch in case of the northern entrance.

The most surprising result of the geophysical measurement are 12 distinct anomalies with intensity of 4 to 16 nT and with a diameter of 4 to 6 m, situated in regular distances between the ditch entrances. It is always three holes between two interruptions. When the opposite holes are connected by lines, their intersections are with slight deviation situated in the middle of the rondel.

We suppose the existence of two other concentric circles with unclear point anomalies inside the inner line, on the axes of the lines of the outer holes. The inner circle has a diameter of 38 m, the other one 60 m. However, this interpretation is hypothetical and could be confirmed by a new measurement by a magnetometer of higher sensitivity (0,001 nT).

KOČÍN, Trnava district

A roundel of a diameter of 60-70 m was detected as a positive crop mark in low maize on 9 June 2004 (Fig. 1b). It lies 180 m above sea level on a slight slope orientated south-eastwards.

Geophysical measurements on the site were processed into a map of residual magnetic anomalies (Fig. 2b). Negative factor was the presence of an iron pipeline, only the south-eastern part of the enclosure can thus be used for interpretation as two ditches can be identified here, probably with two interruptions.

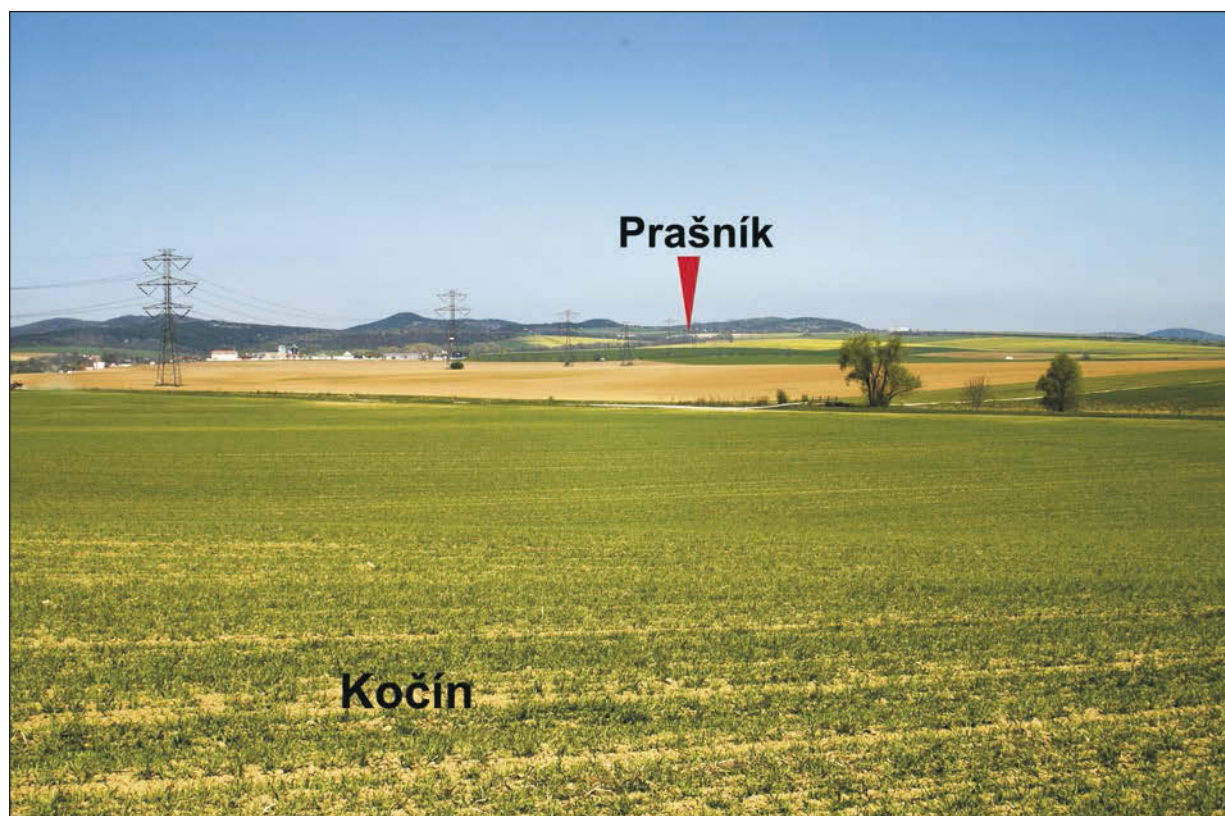

Fig. 7. View from Kočín on Prašník.

The original intention to analyse these rondels with regard to the orientation of the gates was made impossible by the presence of the pipeline running through the Kočín rondel, which also disabled its exact interpretation. We have therefore only analysed mutual visibility with respect to the geometric centre of the rondels.

As a basis DRM (Fig. 3) was used, acquired by vectorisation of contour lines of the Basic map of the Slovak Republic in scale 1 : 10 000. These contour lines were supplemented with terrain edges and with height points. Superstructure ArcGIS - 3D Analyst was used to generate a terrain model in TIN form, which was for the purpose of further analyses converted to grid with cells of 10 m.

The process of analysis was as follows (Fig. 4):

- for each rondel an individual binary grid was generated, with visibility values 1 - visible, and 0 - invisible
- the grids were summed up
- the final grid shows the number of places from which a particular cell of the grid is visible at the same time, or how many places are visible from a particular cell at the same time

For this process the so-called "Geoprocessing" instrument was created in ArcGIS - Model Builder environment, which also allows analyses on a different area or on different sites (Fig. 5). This instrument can be modified to script, which is used for batch processing of several sites and for generating of "Visibility matrix" (Lieskovský, 2006).

When analysing we assumed visibility from Earth's surface, i.e. we did not add any artificial height above the terrain. With respect to the short mutual distance we did not account for the influence of atmospheric refraction or for earth curvature. This influence can be modelled and must be accounted for especially in case of more distant points, for in this way artificial visibilities could be created, which are in reality impossible because of earth curvature.

The results imply that both rondels were mutually visible almost on the whole area. From the visibility of the surrounding area (Fig. 6) we can assume that they might have been built deliberately out of the requirement about their mutual visibility. This assumption is especially valid for the Prašník rondel, as almost the whole area is situated in the zone of mutual visibility (red colour), while the closest area is partially or completely invisible. This analysis was experimentally verified in the terrain (Fig. 7).

In conclusion, the spatial analyses of archaeological objects and their relations may bring significant results. The analyses contribute especially to a better understanding of the function and significance of these constructions.

However, the analyses and their interpretations have their limitations caused by both the methods and the quality of input data. In case of rondels it will be interesting to observe the mutual visibility with regard to the orientation of the gates and inner features. The basic and necessary assumption is the simultaneous existence of these constructions in the same period.

REFERENCES

- Dreslerová 1996* D. Dreslerová: Modelování přírodních podmínek mikroregionu na základě archeologických dat, In: Archeologické rozhledy 48, Praha 1996, 605-712.
- Kuzma 2002* I. Kuzma: Rondel v Prašníku. AVANS 2001, 95-96.
- Kuzma/Bartík/Rajtár 2003* I. Kuzma/M. Bartík/J. Rajtár: Letecká prospekcia na juhozápadnom Slovensku, AVANS 2002, 2003, 70-77, 190-193.
- Lieskovský 2006* T. Lieskovský: Priestorové analýzy prehistorických objektov na mapách. Diplomová práca, KGZA STU SvF, Bratislava 2006.
- Rapant 2005* P. Rapant: Geoinformační technologie. Inštitút geoinformatiky, VŠB TU Ostrava 2005, 71-80.

Ivan Kuzma
Archaeological institute of SAS
Akademická 2
949 21 Nitra, Slovakia
ivan.kuzma@savba.sk

Tibor Lieskovský
KGZA SvF STU Bratislava
Radlinského 11
813 68 Bratislava, Slovakia
tibor.lieskovsky@gmail.com

GEOPHYSICAL PROSPECTING OF DESERTED VILLAGE DOLNÝ POLTÁR

Ján Tirpák - Eva Fottová - Martin Bartík

Key words: dipole electromagnetic profiling, ground penetrating radar, magnetometry, digital terrain model, Middle Ages, deserted village

Archaeological excavation of a deserted village Dolný Poltár was realized in 1965-1968 by Institute of Archaeology of Slovak Academy of Sciences in Nitra under the direction of I. Hrubec. Site is situated in the south of the central Slovakia in the valley of the river Ipel', at the south-western edge of town Poltár. The first known written record about medieval village in Dolný Poltár comes from the mid 13th century. Village was deserted in the 17th century.

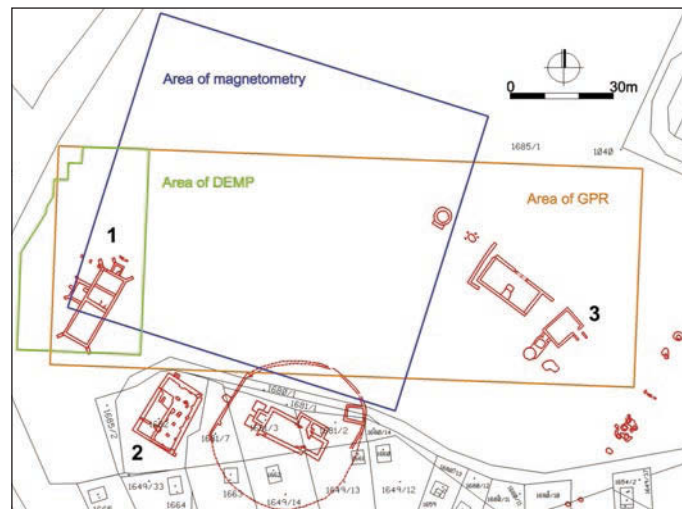

Fig. 1. Plan of archaeological excavation in Dolný Poltár. 1 - manor house 15th century; 2 - manor house 16th century; 3 - tower 13th century.

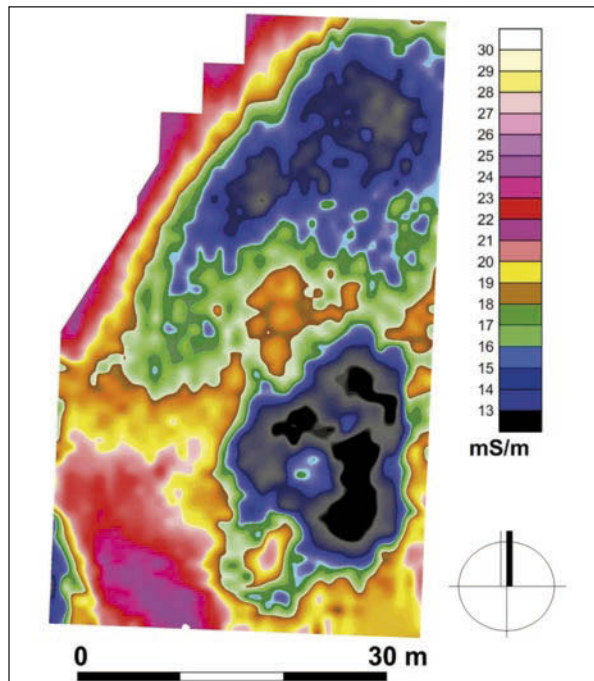

Fig. 2. Dolný Poltár. Map of apparent conductivity, dynamics 12-32 mS/m in 256 colour values from black to violet.

In the course of four excavation seasons major part of the village was explored (Fig. 1). Three manors, a church with a cemetery and several outbuildings were unearthed. In the 13th century two- to three-storey stone-built residential tower and one-nave gothic church with cemetery were established in Dolný Poltár. In the later periods the cemetery was enclosed by a stone wall and ossarium was built there. In the 15th century a new gothic manor was established. It was built on the rectangular ground plan (23 x 8 m) with northern tower and western annex. The third manor - a mansion of the Sóos' family originated in the course of the 16th century. It consisted of fortified renaissance building with a tower and inner courtyard and was rebuilt after fire in the second half of the 16th century. The village and Sóos' mansion deserted during the Turkish raids in the 17th century. In 1791 remaining stones from the ruins were collected and used for the construction of a new church in Horný Poltár village (present Poltár). At the same time the inhabitants from deserted Dolný Poltár moved to Horný Poltár, too.

It was during the archaeological excavation of Dolný Poltár in 1966 when non-destructive resistivity profiling method was used for the first time in Slovakia that was aimed at localisation of the church. On the spots with anomalies of apparent resistivity the negatives of church foundations and stone enclosure were uncovered.

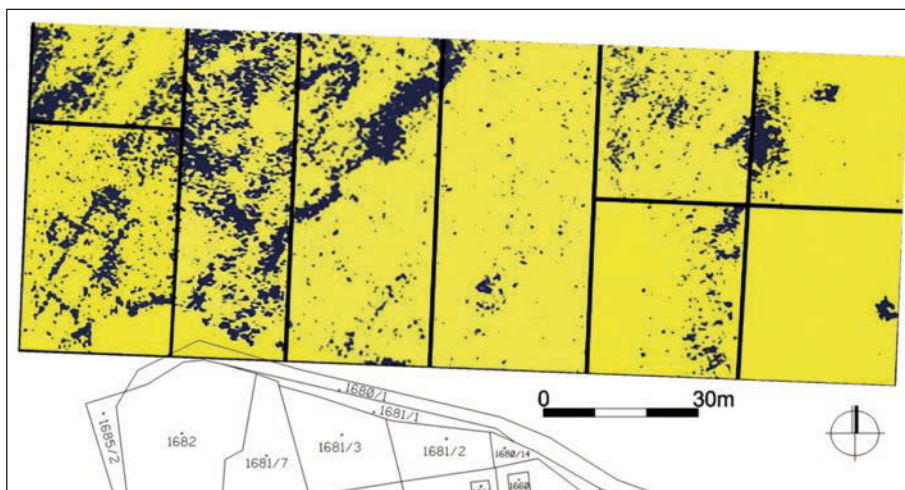

Fig. 3. Dolný Poltár. Magnetogram, dynamics 20 - 110 in 256 colour values from blue to violet.

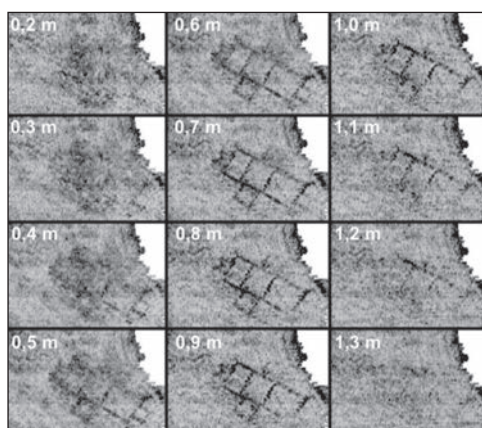

Fig. 4. Dolný Poltár. GPR survey of the 15th century manor, selected amplitude time slices.

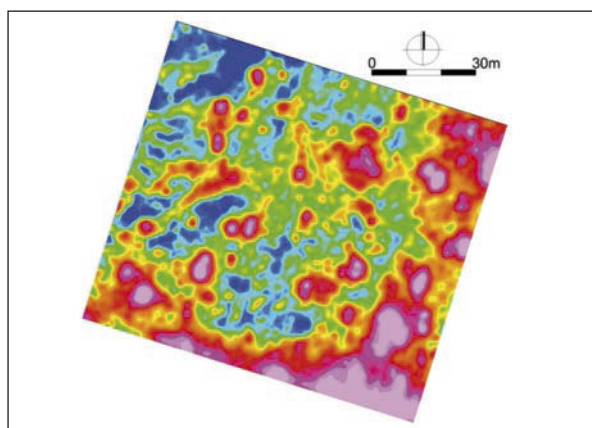

Fig. 5. Dolný Poltár. GPR survey of archaeological structures, selected amplitude time slice for depth = 0,35 m.

The main goal of the geophysical prospecting in 2006-2007 was to investigate the preservation condition of the archaeological structures uncovered in the course of excavation in the past and buried again as well as to detect up-to-now unknown archaeological structures. Total area of 1,5 ha with the point density 0,5 x 0,2 m was measured. Several non-destructive methods were used at the site, namely mapping and survey, dipole electromagnetic profiling (DEMP), magnetic and ground penetrating radar (GPR) measurements.

The DEMP results are presented on the map of apparent conductivity for the area 60 x 37 m (Fig. 2) where anomalies reach the values from 12 to 32 mS/m. The conductivity values below 15 mS/m indicate present remains of the foundation masonry and stone destruction of the 15th century manor. In the north-eastern part of prospected area the lower conductivity value is caused by the presence of foundations, probably preserved only in their negatives.

Magnetic measurement was carried out on the area 100 x 90 m with the point density 0,5 x 0,2 m. Local anomalies on the map of analytic signal of magnetic field (Fig. 3) indicate presence of archaeological structures of a settlement character.

Obtained results of GPR measurements with 500 MHz antenna completed the information about the building development of the 15th century manor (Fig. 4) where new southern annex, division of inner space by two division walls and foundation walls with the width 80-100 cm in the depth 40-160 cm were specified. Furthermore, in the north-western and eastern part of prospected area a concentration of anomalies indicating up-to-now unknown and unexcavated archaeological structures was detected (Fig. 5).

REFERENCES

Hrubec 1971

I. Hrubec: Výskum zaniknutej dediny Dolný Poltár. Archeologické rozhledy 23, 1971, 69-79.

Ján Tirpák, Eva Fottová, Martin Bartík

Archaeological institute of SAS

Akademická 2, 949 21 Nitra, Slovakia

jan.tirpak@savba.sk, nraufott@savba.sk, martin.bartik@savba.sk

GEOPHYSICAL PROSPECTING IN POROLISSUM, ROMANIA

Ján Tírpák - Ján Rajtár - Alexander Matei - Florin Scurtu - Vladimír Varsík

Key words: Roman city, magnetometry

Porolissum is one of the largest and best preserved archaeological sites in Romania. It is an ancient Roman city established by the Roman Emperor Trajan in 106 AD. In the course of the time the site developed from a large military base for 5000 auxiliary soldiers to a Roman city of about 25000 inhabitants (*Matei 1997*).



Fig. 1. View of the Porolissum site.

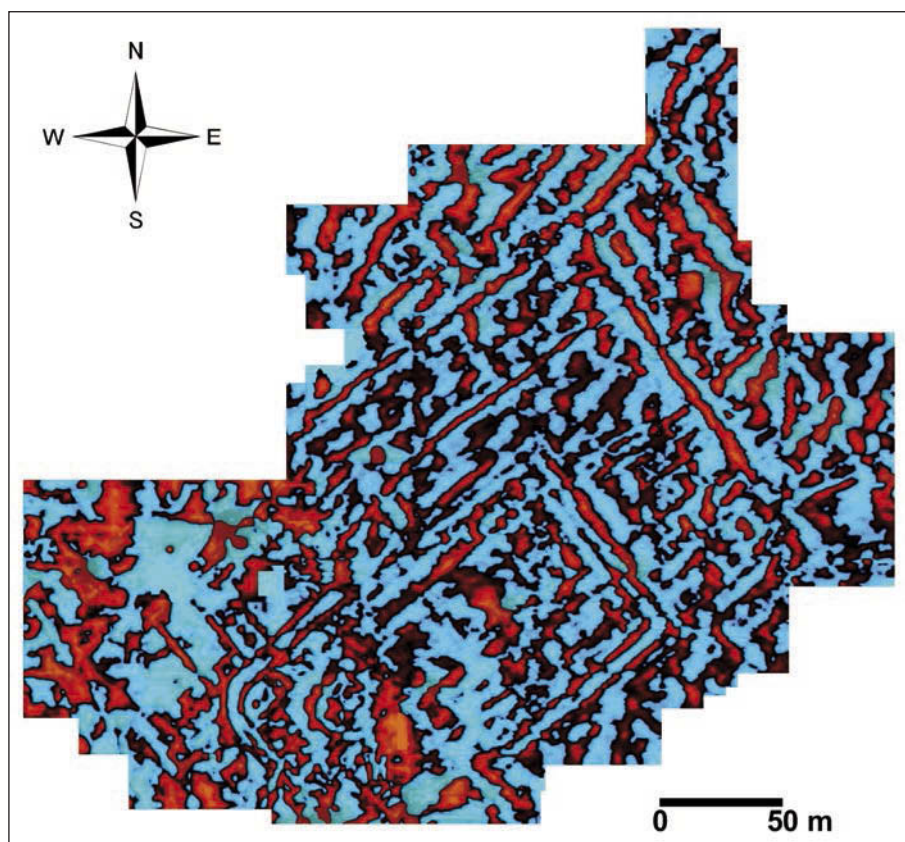

Fig. 2. Porolissum. Magnetogramm, dynamics ± 75 Nanotesla in 256 colour values from blue to orange.

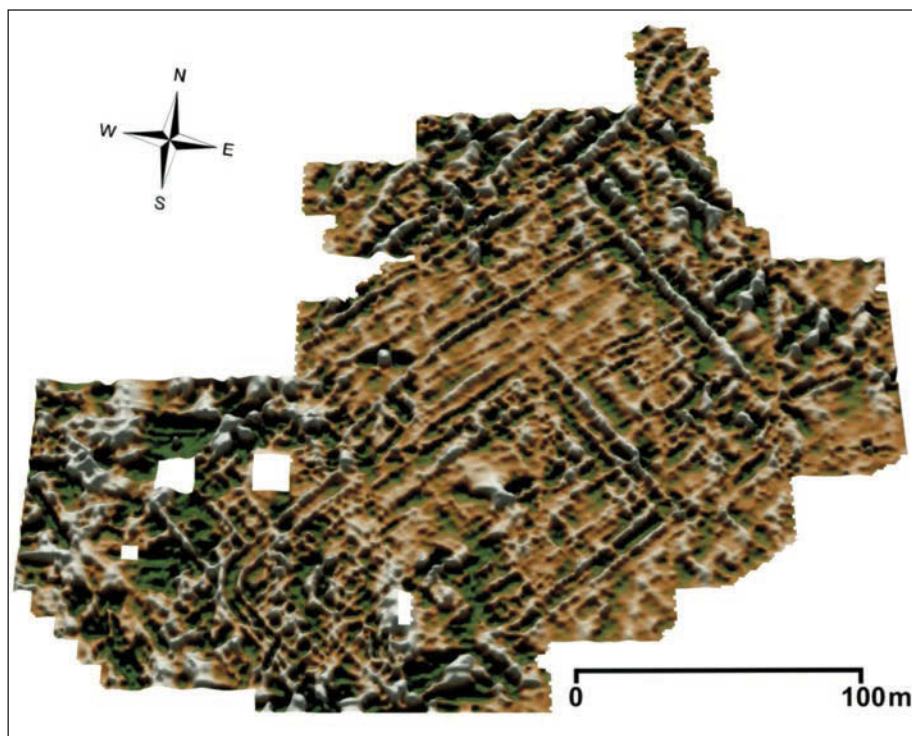

Fig. 3. Porolissum. 3D visualization of magnetogramm.

In 1982 geophysical prospecting (magnetic measurement) was realized in the cooperation of Zalău County Museum of Art and History in Zalău (Romania) and Institute of Archaeology SAS in Nitra (Slovakia). An area 300 x 300 m was measured with Cesium Smartmag SM 4 magnetometer (point density 0,15 x 0,5 m) and with proton magnetometer (point density 1 x 1 m, Fig. 1). As the geological bedrock is formed by neovolcanites, the high values of magnetic anomalies were expected. On the spots with the large terrain gradient corrections were made before data interpretation.

On the map of residual magnetic anomalies (Fig. 2), where data from both magnetometers were joined, it was possible to specify line anomalies with intensity from -75 nT to 75 nT that indicate terraces, street system and structure of neovolcanites - built foundation walls of architectural complexes - individual buildings of the city. *Forum* area is dominating on the 3D visualization of magnetogramm (Fig. 3). *Forum* represented a centre of the city that covered an area ca. 100 x 85 m and appears to consist of a central court that might have served as a marketplace, of basilica on the northern, and of the public buildings, porticoes and shops along the western, eastern and southern sides.

The results of the geophysical prospecting are gradually verified by archaeological excavation within the American-Romanian project (2006-2010) focused on the Porolissum Civic Forum (www.porolissum.org).

REFERENCES

Matei 1997

A. V. Matei: "A new defensive line discovered at the Roman military site of Porolissum in Dacia Porolissensis." In: *Roman Frontier Studies*, Oxford, 93-101.

Ján Rajtár
Vladimír Varsik
Ján Tirpák
Archaeological institute of SAS
Akademická 2
949 21 Nitra, Slovakia
jan.rajtár@savba.sk
vladimir.varsik@savba.sk
jan.tirpak@savba.sk

Alexander V. Matei
County History and Art Museum
Str. Unirii 9
450 42 Zalău, Romania
muzeu@zalau.astral.ro

Florin Scurtu
GEI - PROSECO
Str. Sibiu 10
773 17 București, Romania
florinscurtu@pcnet.ro

GEOPHYSICAL PROSPECTING OF THE BRONZE AGE SITE AL-KHIDR, FAILAKA ISLAND, STATE OF KUWAIT

Peter Barta - Martin Bartík - Lucia Benediková - Jozef Ďuriš - Karol Pieta -
Shehab A. H. Shehab - Svorad Štolc, Jr. - Ján Tirpák

Key words: *Al-Khidr, Failaka, Bronze Age, Early Dilmun, dipole electromagnetic profiling (DEMP), ground penetrating radar (GPR), stone architectures, 3D modeling*

Abstract

Al-Khidr is a Bronze Age (Early Dilmun) site in the north-west of Failaka that has been excavated by the Kuwaiti-Slovak Archaeological Mission (KSAM) since late 2004. The site indicated by numerous sherds and stone alignments over uneven surface is not in full accessible for digging. While a smaller part on the western shore of Al-Khidr Bay is fully accessible for both non-destructive and destructive archaeology, a larger portion below the ground of a modern Islamic cemetery is available only for field-walking and geophysical prospecting (Fig. 1)

Geophysical survey, which is aimed at tracing archaeological structures to estimate the extent of the site, has been carried out at Al-Khidr since 2004. Unlike DEMP and GPR, magnetic method turned to be unsuitable due to the large amounts of iron (Gulf War) spoiling the signal.

DEMP

During the first season (2004) the shoreline part of the settlement and 2 smaller test areas in the cemetery were measured by DEMP and maps of apparent resistivities were produced (values 16 - 34 Ohm.m for horizontal component and 9 - 20 Ohm.m for vertical component, device EM38 from Geonics Company/Canada).

After comparing results of the DEMP measurements with results of excavation it was possible to associate anomalies on the shoreline with the Bronze Age architectural remains (value 29-34 Ohm.m for horizontal and 17-20 Ohm.m for vertical component, pink and violet colours; Fig. 2). In the next seasons (2006, 2007) the whole cemetery ground was prospected by DEMP. The map of apparent resistivities for the cemetery showed same values of anomalies as the map for the area along the shoreline. This fact together with Bronze Age sherds from the surface of

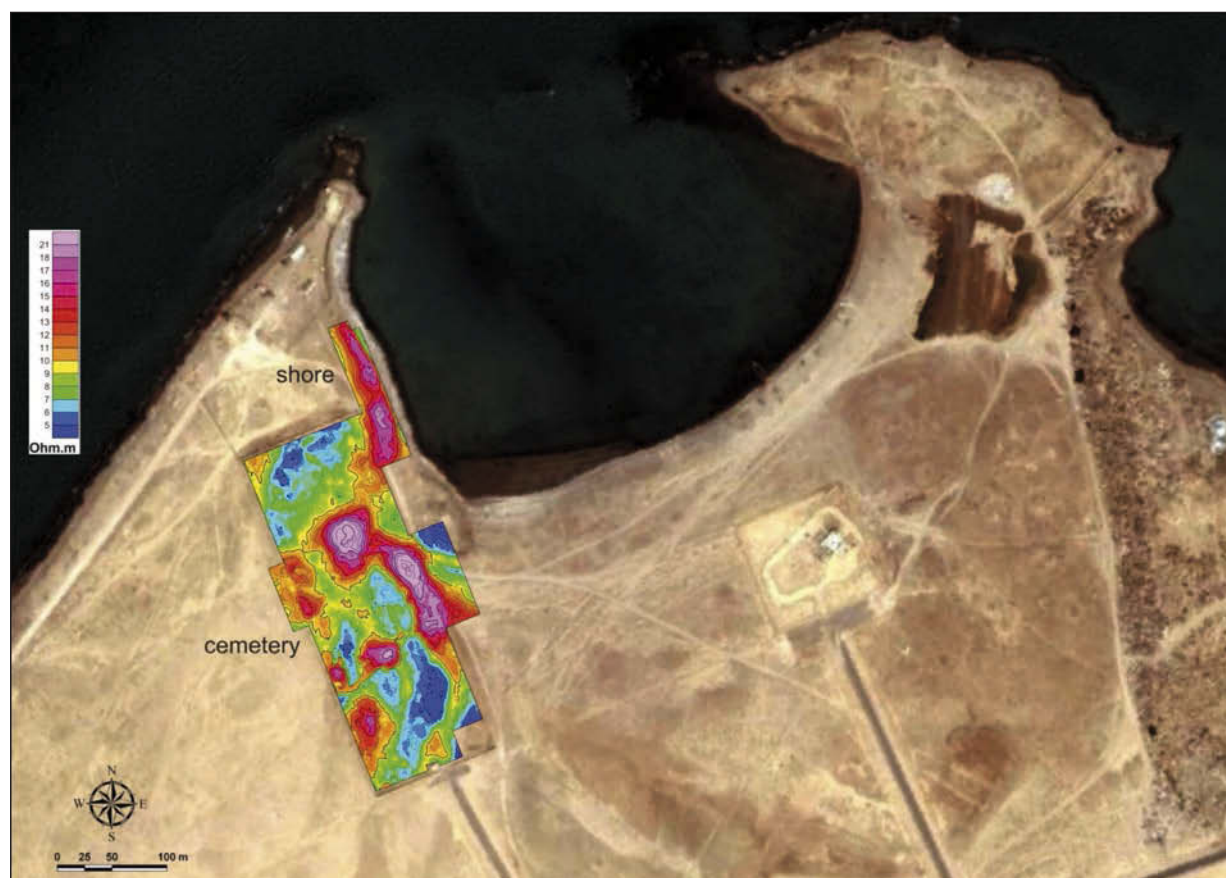

Fig. 1. General view of Al-Khidr site with general map of apparent resistivity for vertical component.

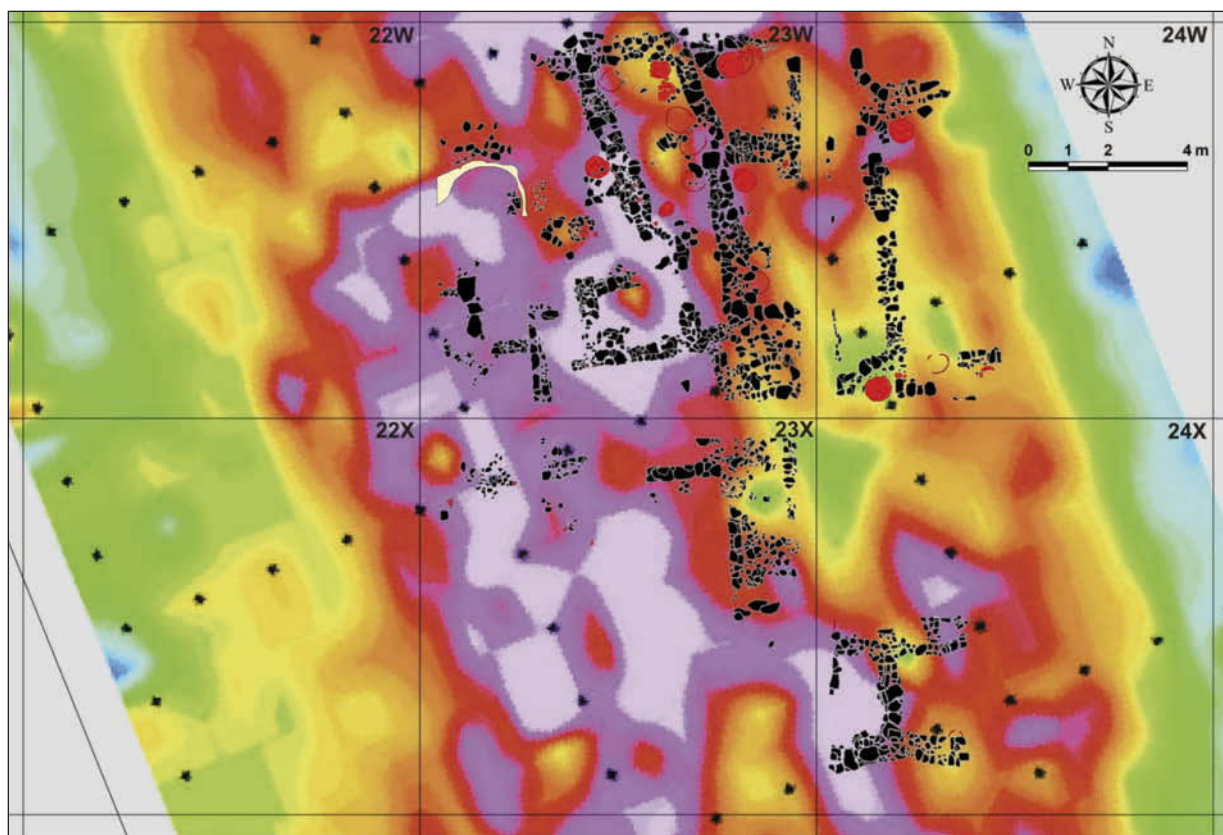

Fig. 2. Comparison of geophysical (DEMP, horizontal component) and archaeological results on the shore of Al-Khidr.

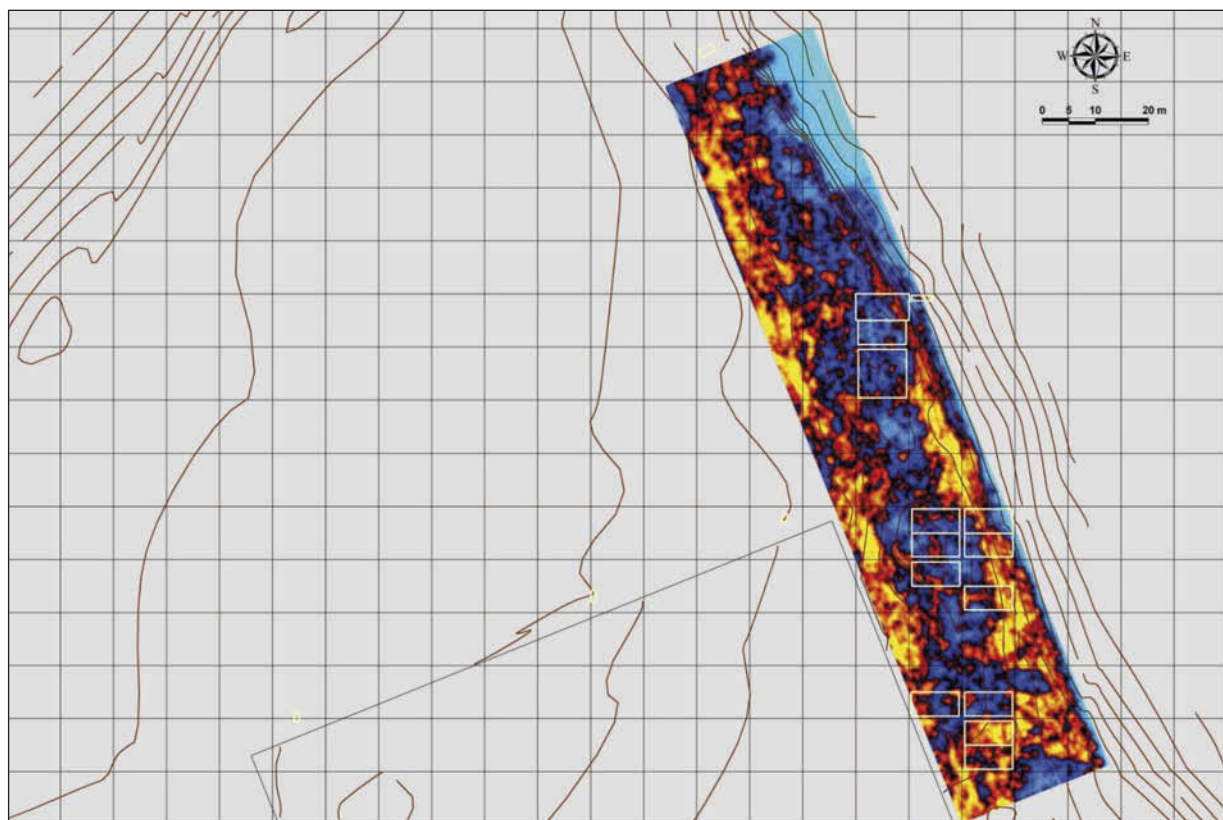

Fig. 3. GPR results for Al-Khidr shore.

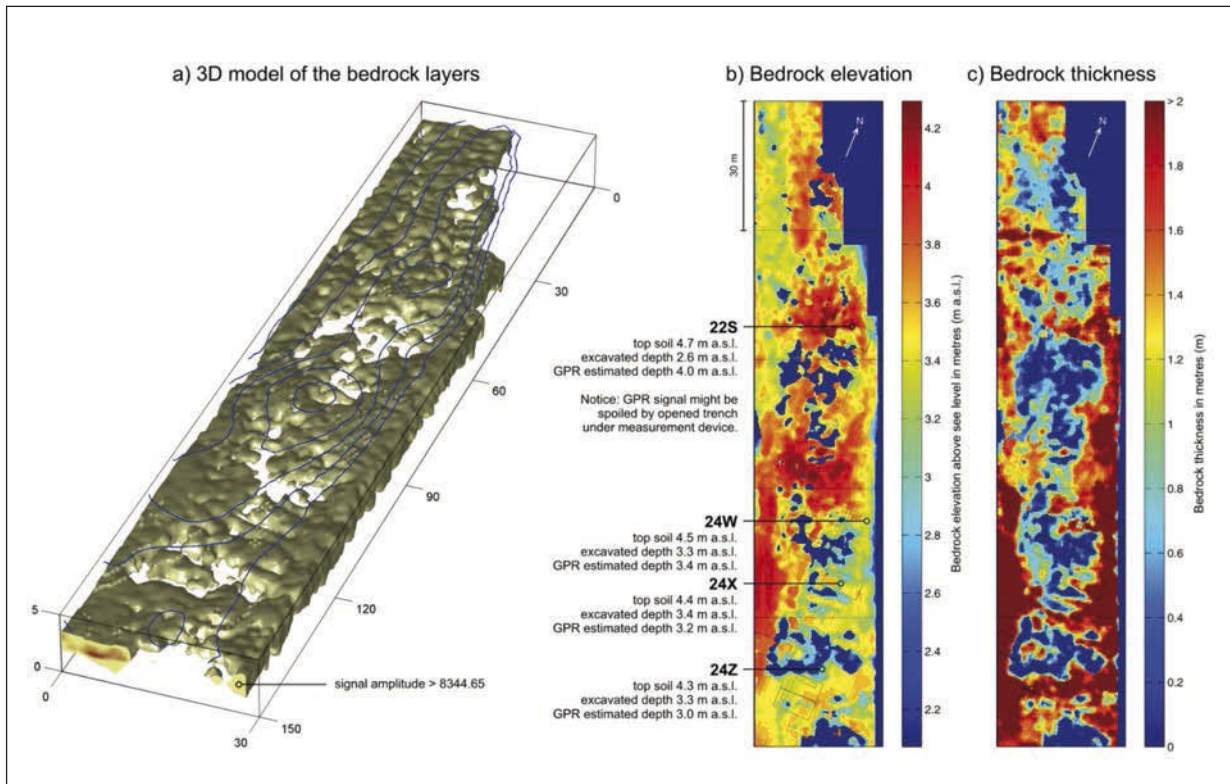

Fig. 4. 3D model of bedrock layers on Al-Khidr shore on the basis of GPR data (250 MHz antenna).

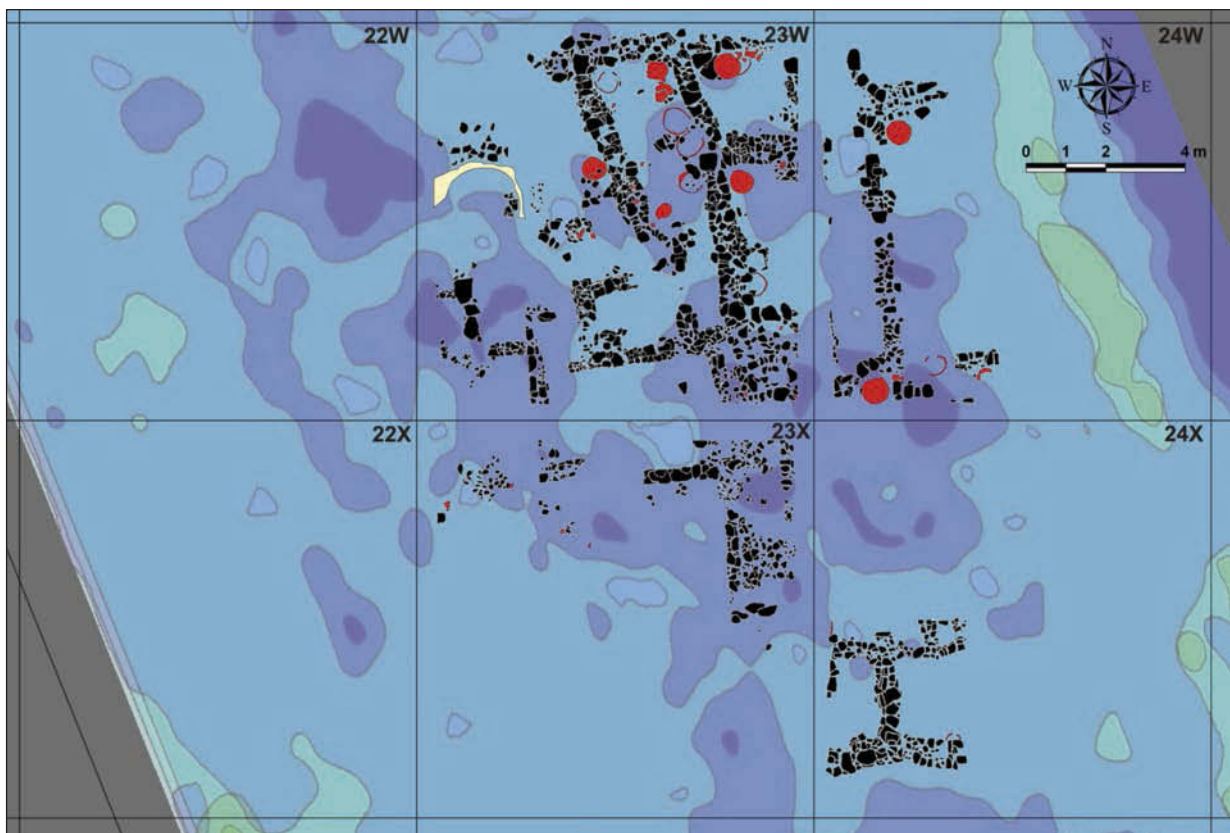

Fig. 5. Comparison of geophysical (GPR, 250 MHz antenna, depth 75 cm) and archaeological results on the shore of Al-Khidr.

the cemetery allowed us to assume here some Bronze Age architectures and to conclude that the Bronze Age settlement spread from the shoreline to the south-west (Fig. 1). However, a sounding in the peripheral zone of the apparent resistivity anomaly outside the middle of eastern cemetery wall did not prove any buried features. As the core of the anomaly lies inside the cemetery, which must for now remain unexcavated, we could not investigate its origin.

GPR

The areas on the shore and in the cemetery previously measured by DEMP were in 2006 and 2007 surveyed by GPR (device RAMAC X3M from Geoscience Malå Company/Sweden with 250 MHz and 500 MHz antennas). The GPR collected data have been presented in vertical and horizontal plains and further analysed by a complex image processing.

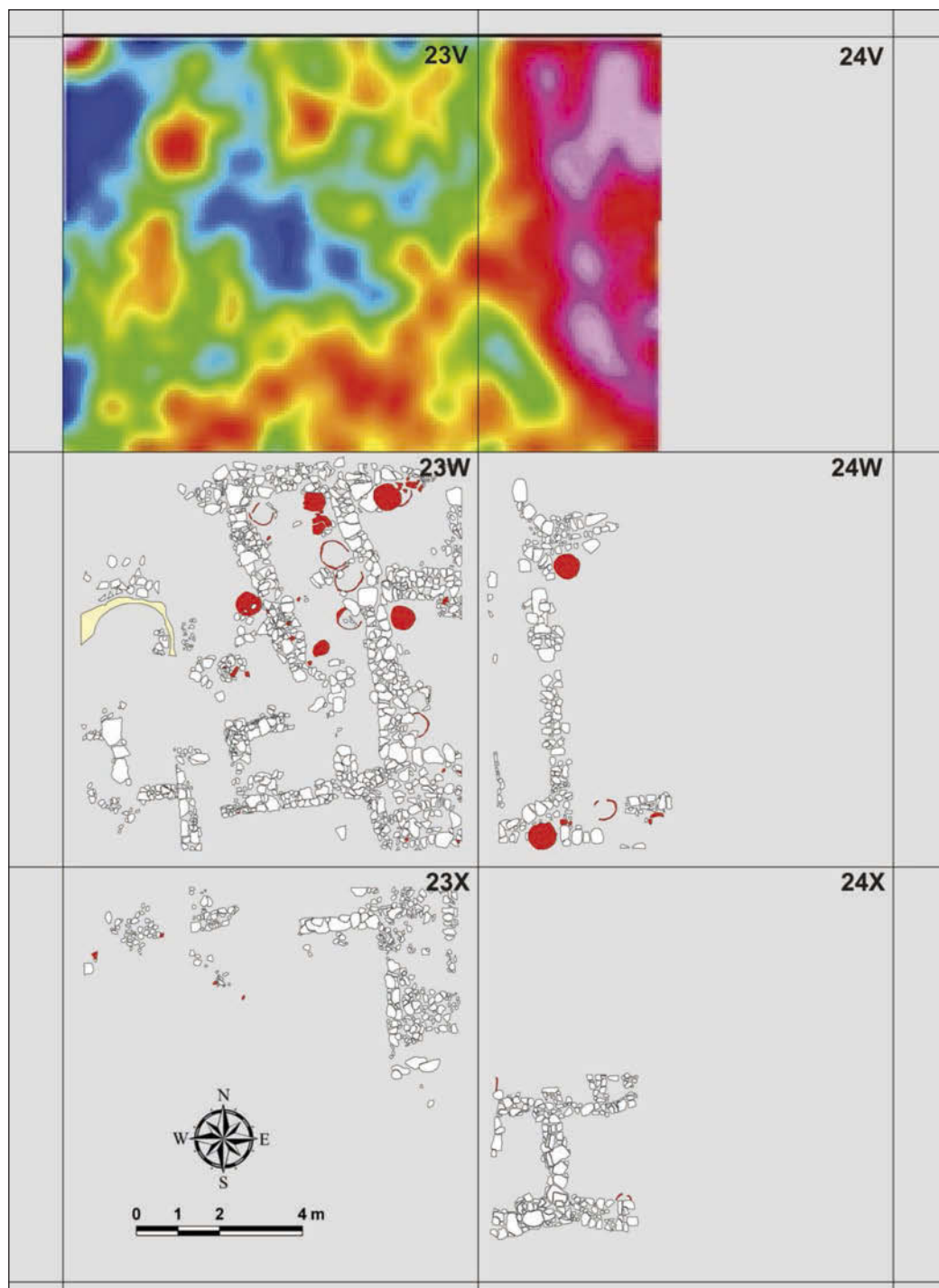

Fig. 6. Comparison of geophysical (GPR, 500 MHz antenna, depth 30 cm) and archaeological results on the shore of Al-Khidr.

As for the shore (250 MHz antenna), the areas with the highest amplitude of signal (value from 10000 to 23000; yellow and orange) are in the horizontal view recognizable as two curved lines (Fig. 3). The eastern one corresponds with the course of the coastline, i.e. with the solid sea rock sloping down to the bay and forming its present bottom. Similarly, the western line might correspond with other solid sea-rock formation, perhaps marking an earlier coastline. This preliminary view could support stratigraphic observations throughout the site (investigated by 9 test soundings along the cemetery wall). Irregular course of layers of hardened sand and other marine sediments, as well as varying level of water table testify to local changes of palaeorelief. As seen on the vertical GPR profiles, the bedrock layer between the two curved lines is not fully interrupted. Even a 3D model of the bedrock layers built from the vertical GPR profiles hardly shows major disturbances of the bedrock in the extent estimated from Fig. 3 on the spots with lower amplitude of signal (below 8344.65; Fig. 4a, 4b). Accordingly, the hypothesis about an earlier coastline has to be viewed with caution.

The 3D bedrock modeling as well as depth and thickness estimation (Fig. 4b, 4c) has been carried out using the scientific computational environment Matlab R2006a. Fairly good agreement between real bedrock depths and GPR estimated depths has been achieved in three soundings 24W, 24X, 24Z. However, in 22S a substantial estimation error has been observed (Fig. 4b). Nevertheless, in this particular case the GPR signal might have been spoiled by opened trench under the GPR device while measuring. Therefore we may assume that our view of the bedrock layers is generally correct.

However, the main goal of prospecting by GPR was to detect archaeological (architectural) remains. Leaving the areas of the highest amplitude of signal out of consideration, relation of GPR results (250 MHz antenna) with archaeological remains is rather problematic. As shown on the general horizontal slice for the measured area on the shore, the anomalies with amplitude of signal 3500-5000 (dark blue) follow the main course and orientation of the excavated architectures from the Bronze Age (Fig. 3). However, as seen from detailed comparison of GPR images with what has been excavated, the radar signal from certain depths does not indicate buried stone architectures (Fig. 5).

The 500 MHz antenna applied on two small areas on the shore (trenches 22S, 23V, 24V) turned out to be more appropriate for this type of environment as it shows more details in the course of the ground plans of underground structures. Fig. 6 shows e.g. continuation of the stone walls from trench 23W to the north (23V). At the same time it has to be kept in mind that the 500 MHz antenna, like the 250 MHz one, reflects not only archaeologically interesting structures (e.g. stone foundations) but also natural layers of sea rock that occur very close to surface on spots with lower altitude.

Even though some details from GPR horizontal slices (250 MHz antenna) and DEMP maps of resistivities depict, perhaps, the same facts (Fig. 2; 5), the GPR results from the 250 MHz antenna (used for the whole investigated area) cannot be unambiguously interpreted, even for the excavated area.

Therefore, neither the linear anomalies on the 250 MHz antenna horizontal slices from the cemetery allow univocal conclusion about the presence or absence of the Bronze Age stone architectures.

Conclusion

As seen from comparisons of geophysically measured data and excavated situations, a simplistic interpretation of geophysical maps from environment of Al-Khidr may well be over- or misinterpretation of the buried features. Having learned our lesson on the shore, the question of the presence and extent of the Bronze Age structures in the cemetery seems to be open.

Beyond work at Al-Khidr site, KSAM is involved in the general archaeological survey of Failaka employing the geophysics also elsewhere on the island. This first extensive survey project in the north of Arabian Gulf (for more details see paper on Al-Qusur site in this volume and) is possible only thanks to generous financial and material support of National Council for Culture, Arts and Letters (State of Kuwait) and the scientific background provided by the Institute of Archaeology of Slovak Academy of Sciences (Nitra, Slovakia).

Peter Barta
 Dendrolab Bratislava
 PO BOX 83
 Karloveská 34
 840 00 Bratislava, Slovakia
 peterbarta@chello.sk

Shehab A. H. Shehab
 National Council for Culture,
 Arts and Letters, State of Kuwait
 P.O. Box 23996
 13061 Safat-Kuwait
 State of Kuwait
 knm2000@hotmail.com

Svorad Štolc, Jr.
 Institute of Measurement Science SAS
 Dúbravská cesta 9
 841 04 Bratislava, Slovakia
 umerstol@savba.sk

Martin Bartík
 Lucia Benediková
 Jozef Ďuriš
 Karol Pieta
 Ján Tirpák
 Archaeological institute of SAS
 Akademická 2
 949 21 Nitra, Slovakia

martin.bartik@savba.sk
 luciabenedikova@yahoo.com
 jozefduris@seznam.cz
 karol.pieta@savba.sk
 jan.tirpak@savba.sk

ARCHAEOLOGICAL AND GEOPHYSICAL PROSPECTING OF DESERTED EARLY ISLAMIC
VILLAGE AL-QUSUR (FAILAKA ISLAND, STATE OF KUWAIT)Karol Pieta - Shehab A. H. Shehab - Ján Tirpák - Mario Bielich -
Martin Bartík - Jozef Ďuriš

Key words: ground penetrating radar (GPR), archaeological excavations, settlement units, Early Middle Ages (6th-8th cent. AD), Al-Qusur, Failaka Island, Kuwait

Abstract

First records of a settlement at Al-Qusur site inland of the Failaka Island with exceptionally well preserved foundations of settlement units (houses with enclosures) come from 1960 aerial prospecting.

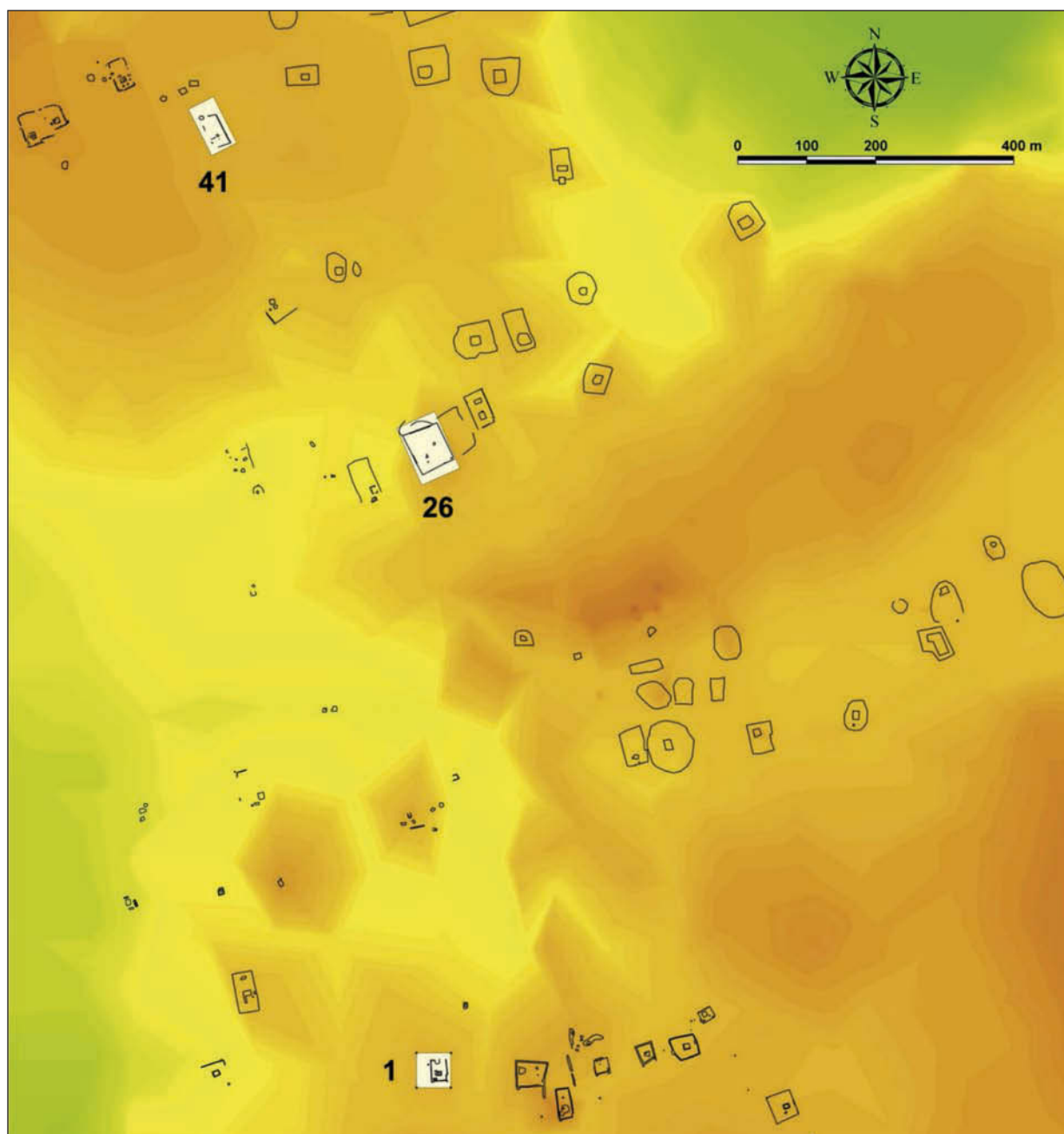

Fig. 1. Plan of Early Medieval village at Al-Qusur on digital terrain model.

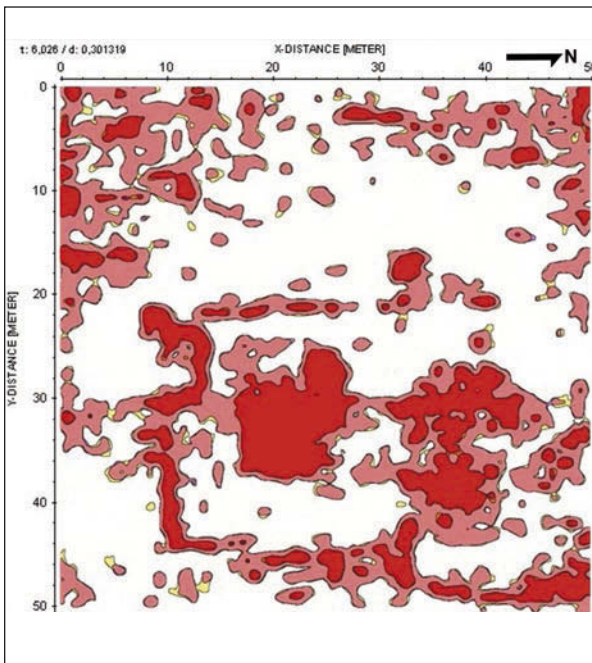

Fig. 2. Horizontal time slice for depth 0.3 m on the area of settlement unit 1.

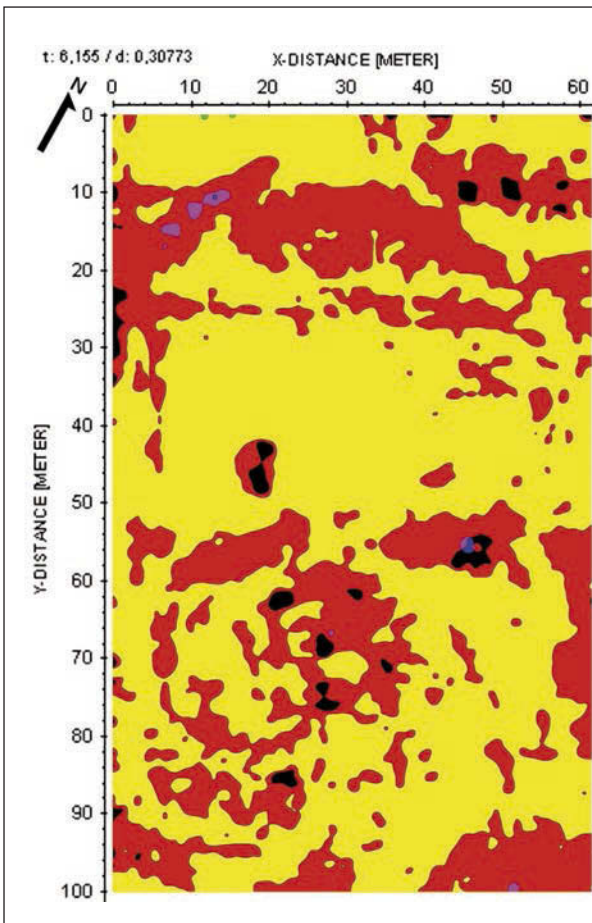

Fig. 3. Horizontal time slice for depth 0.3 m on the area of settlement unit 26.

Early Medieval village at Al-Qusur was discovered and first excavated by Italian mission in 1970s (*Patitucci/Uggeri 1984*). In late 1980s it became a part of a research project of the French mission that discovered and excavated, inter alia, a church there (*Callot/Calvet 1999*).

In the course of excavations in 1970s Italians uncovered two houses in the centre of the site. In the monograph about discoveries on Failaka they presented a general plan of Al-Qusur settlement that does not show all the houses and enclosures, however. At the end of 1990s the French mission worked out a new plan that was accessible for us only as a copy of a low quality without numeration of individual objects.

According to the results of both missions it is possible to say that the centre of the site was a monastery with a church (6th-7th cent. AD) surrounded by densely settled area. In its broader surroundings a large village was located with ca. 80 settlement units organized in rows that can be dated to the Early Islamic period (7th-8th cent. AD, Umayyad and Early Abbasid dynasties).

Scientific program of the Kuwaiti-Slovak Archaeological Mission (KSAM) at Al-Qusur started in February 2006. Apart from field walking, ground penetrating radar (GPR) was employed on the site.

Archaeological prospecting

In 2006 KSAM mapped and surveyed sparser settled and not yet completely documented southern part of the Early Medieval village. Most of the settlement units were sketched and some were 3D modelled in PC on the basis of the surface details observed in field.

Only three units were prospected in details with the main goal to obtain datable material. One of the units, No. 1-S (81 according to Italian numeration), was prospected using two geophysical methods - GPR and dipole electromagnetic profiling (DEMP).

In the course of survey in February and March 2007, 26 settlement units as well as number of simpler structures was mapped on the western and very southern edge of the Early Medieval settlement at Al-Qusur and previous plans by Italian and French missions were corrected in important details. Settlement units 26 and 41 were surveyed by GPR.

According to the knowledge obtained by three missions (Italian, French, KSAM), the southern part of the village was organized on linear ground plan (with main axis in W-E direction) where enclosures and houses had N-S orientation. The settlement unit consisted of the house, generally built of mud bricks on stone foundations, outbuildings (e.g. barns, storerooms) and other structures (e.g. fireplaces, wells, water cisterns).

In several settlement units, particular details, such as turrets in the corners of enclosures, tower-like central houses, well defendable entrances etc., could have been observed.

As for an extent of the settlement, in comparison to previous knowledge, KSAM proved much larger area inland of Failaka was occupied during Early Middle Ages (Fig. 1). The eastern and western borders of the settlement area are, at the present time, clearly delimited by the marshes.

GPR prospecting

GPR data were obtained using RAMAC X3M (Geoscience Malå, Sweden) device equipped with 500 MHz shielded antenna. Selected areas were measured along parallel profiles with mutual distance 0.50 m, in a step mode of 0.035 m and time window of 60 ns.

The time slice data were processed in Reflex-Win Sandmeier Software (Germany) and Oasis Montaj (Geo-soft Inc., Canada).

Three areas were measured with GPR: 1. settlement unit 1 (50 x 50 m; Fig. 2), 2. settlement unit 26 (60 x 100 m; Fig. 3), 3. settlement unit 41 (40 x 77 m; Fig. 4).

On each horizontal slice the structures can be identified between 0 ns to 5 ns and from 23 ns to 40 ns. Time slices (Fig. 2, 3, 4) clearly show that anomalies are caused by the foundations of the houses and enclosures. The results obtained with GPR within all investigated areas highlight the relevance of using the method on this specific site. In particular, this method can be used for detection of complete ground plans of the structures only partially exposed on surface.

Conclusions

Recent archaeological excavations confirmed some details of the structures detected by geophysical prospecting. This part of the project is still in progress and new surveys with employment of integrated geophysical methods are planned for the future years.

As for next, field research will be followed by scientific analysis of the obtained material to draw up complex picture of this 6th-8th century AD settlement important for chronological and cultural development in Kuwait and in the whole region of Arabian Gulf.

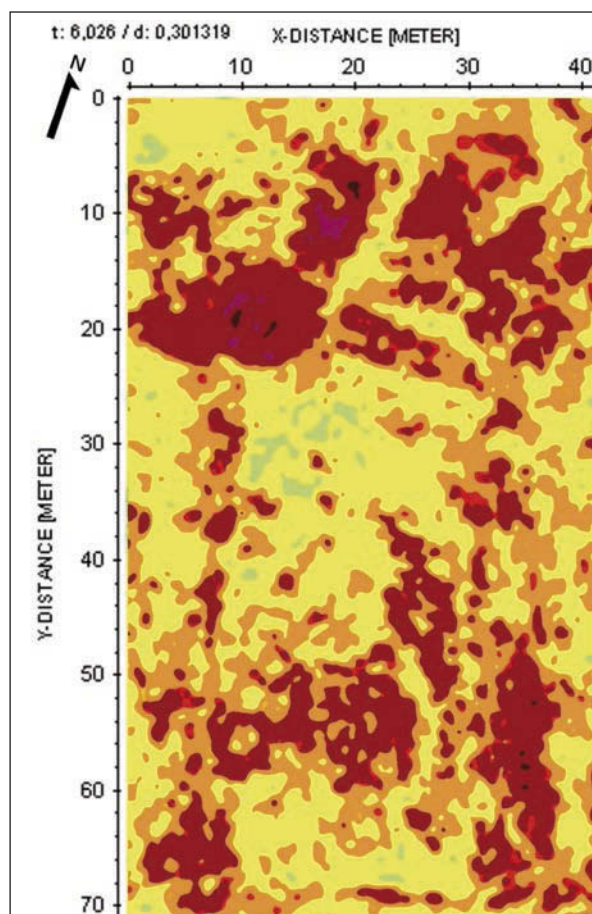

Fig. 4. Horizontal time slice for depth 0.3 m on the area of settlement unit 41.

REFERENCES

- Bernard/Callot/Salles 1991* V. Bernard/O. Callot/J.-F. Salles: L'église d'al Quosur Failaka, Etat de Koweit. *Arabian Archaeology and Epigraphy* 2, 1991, 145-181.
- Callot/Calvet 1999* O. Callot/Y. Calvet: Preliminary report on the topographical mission at Failaka. Unpublished report. Kuwait 1999.
- Elders 2003* J. Elders: Nestorians in the Gulf: Just Passing Through? Recent Discoveries on the Island of Sir Bani Yas, Abu Dhabi Emirate, U.A.E. In: *Archaeology of the United Arab Emirates. Proceedings of the First International Conference on the Archaeology of the U.A.E.* (2001), 2003, 230-236.
- Elders 2001* J. Elders: The lost churches of the Arabian Gulf: recent discoveries on the island of Sir Bani Yas and Marawah, Abu Dabi Emirate, United Arab Emirates. *Proceedings of the Seminar for Arabian Studies* 31, 2001, 47-57.
- Pieta 2007* K. Pieta: Failaka/Al-Qusur. Preliminary report on activities in 2006. Unpublished report. Kuwait 2007.

Shehab A. H. Shehab
National Council for Culture,
Arts and Letters, State of Kuwait
P.O. Box 23996
130 61 Safat-Kuwait
State of Kuwait
knm2000@hotmail.com

Karol Pieta, Ján Tirpák, Mário Bielich
Martin Bartík, Jozef Ďuriš
Archaeological institute of SAS
Akademická 2, 949 21 Nitra, Slovakia
karol.pieta@savba.sk
jan.tirpak@savba.sk
mario.bielich@seznam.cz
martin.bartik@savba.sk
jozef.duris@seznam.cz



ARCHAEOLOGICAL INSTITUTE
OF SLOVAK ACADEMY OF SCIENCES

7th International Conference on Archaeological Prospection

11 - 15 September, 2007, Nitra, Slovakia

under the auspices of the President of the Slovak Republic
Dr. Ivan Gašparovič

TOPICS AND ABSTRACTS

CONFERENCE ORGANISATION

ARCHAEOLOGICAL INSTITUTE OF SLOVAK ACADEMY
OF SCIENCES

INTERNATIONAL SOCIETY FOR ARCHAEOLOGICAL PROSPECTION (ISAP)

ORGANIZING COMMITTEE

Ivan Kuzma - CHAIRMAN - AI SAS
Ján Tirpák - CO-CHAIRMAN - AI SAS
Alexander Ruttkey - DIRECTOR OF AI SAS
Armin Schmidt - PRESIDENT OF THE ISAP

INTERNATIONAL ADVISORY BOARD

Christophe Benech - „Archeorient“ - CNRS, Lyon, France
Marcello Ciminale - Department of Geology and Geophysics, Bari, Italy
Michel Dabas - Université Paris IV, Paris, France
Michael Doneus - Universität Wien, Wien, Austria
Mahmut G. Drahor - Dokuz Eylül University, Buca-Izmir, Turkey
Joerg Fassbinder - Bayerisches Landesamt für Denkmalpflege, München, Germany
Chris Gaffney - GSB Prospection, Cowburn Farm, Bradford, U.K.
Dean Goodman - Geophysical Archaeometry Laboratory, Los Angeles, USA
Tomasz Herbich - Institute of Archaeology and Ethnology, PAS, Warsaw, Poland
Juerg Leckenbush - Institute of Geophysics, Zurich, Switzerland
Wolfgang Neubauer - Vienna Institute for Archaeological Science, Wien, Austria
Yasushi Nishimura - Asia/Pacific Cultural Centre for UNESCO (ACCU), Nara, Japan
Salvatore Piro - ITABC (CNR), Roma, Italy
Alain Tabbagh - Université Pierre et Marie Curie, Paris, France
Gregory N. Tsokas - Department of Geophysics, Aristotele University, Thessaloniki, Greece
Ugur Yaramanci - Technical University of Berlin, Berlin, Germany

INVITED LECTURE

Braasch Otto

Gallipoli Ahead - Air Survey Between the Baltic and Mediterranean

TOPIC 1: AERIAL ARCHAEOLOGY/PROSPECTION

Ceraudo G. Castrianni L.	Poster	Giacomo Boni: a Pioneer of the Archaeological Air Photograph
Korobov D. S.	Poster	Early Medieval Settlements in the Kislovodsk Basin (South of Russia): GIS, Aerial Photography and Geophysics
Kuzma I.	Oral	Aerial Archaeology in Slovakia

TOPIC 2: REMOTE SENSING, IMAGING AND GIS

Ako T. Kamei H.	Poster	Circular Archaeological Survey Based on the GIS at the Sikiryu-site, Kagoshima, Japan
Belinskiy A.	Oral	Usage of "Corona" Satellite Images in the Creation of a Geo Information System (GIS) "Archaeological Sites of the Stavropol Region"
Blažová E.	Oral	The Quality of DTM with Respect to the Used and Definition of Input Data
Colosi F. Fangi G. Gabrielli R. Orazi R. Peloso D.	Poster	Satellite Images and GIS for the Archaeological Park of Chan Chan
Dominici D. Del Guzzo F.	Oral	The Use of Remote Sensing in Archeology: the Example of Capestrano Project
Dovgalev A.	Poster	Geoinformational Monitoring of Archaeological Monuments in the Stavropol Region
Fossataro D.	Poster	Geophysics and Geo-electrical Investigations Integrating the GIS of Iuvanum Survey Project
Frînculeasa A. Frînculeasa M.	Poster	Photogrammetry and Remote Sensing in Archaeology. Benefits and Limits
Frînculeasa M. Frînculeasa A.	Poster	Applications to Landsat Thematic Mapper Imagery in Geosciences Research (Special View to Geology and Archaeology)
Hornák M. Stegmann-Rajtár S.	Oral	Late Bronze Age Settlement in the Middle Nitra Region: Applicability of GIS Analyses
Kuzma I. Lieskovský T.	Oral	Analysis of Roundel Visibility in GIS
Lasaponara R. Lanorte A. Coluzzi R. Masini N.	Oral	On the Use of Satellite Imagery in Archaeological Context: a Comprehensive Review
Masini N. Coluzzi R. Lanorte A. Lasaponara R.	Oral	Performance Evaluation of Edge Detection Algorithms for the Detection of Archaeological Features by Using Satellite Data
Menzio O.	Oral	GIS Project of the Cyrenaican Valleys (Libya)
Merola P.	Poster	Roman Centurie Reconstructed by Hyperspectral Remote Sensing
Trebeleva G.V.	Poster	Geoinformation System (GIS) of Archeological Sites of Northeast Black Sea Coast

TOPIC 3: INTEGRATED PROSPECTION APPROACHES

Bogacki M. Małkowski W. Mikocki T. Misiewicz K. Muszyńska M.	Oral	Multimethodological Approach to the Study of Ancient City Planning: the Case of Ptolemais
--	-------------	---

Bonsall J. Gimson H. Barton K.	Poster	The Role of Integrated Archaeological Geophysical Surveys in Development-led Housing and Road and Community Projects in Ireland
Campana S. Piro S. Felici C.	Oral	Integration between Different Remote-sensing Surveys to Characterise Aiali Archaeological Site (Grosseto, Central Italy)
Dabas M. Cassassolles X. Chemin M. Conte L./ Favard A. Valet J. M. Simon F. X.	Poster	Integration of ARP and AMP for Rescue Archaeology: Example of a 50 ha Project
Dernoga M. Herbich T. Pietrzak R. Rączkowski W. Święch D.	Poster	Discovering Medieval Szamotuły (Wielkopolska Region): a Multidisciplinary Approach
Drahor M. G. Kurtulmuş Ö. T. Berge M. A. Hartmann M. Speidel M. A.	Oral	Large-Scale Magnetic Imaging and Electrical Resistivity Tomography Studies in a Roman Military Installation Area in Zeugma Archaeological Site, South-eastern Turkey
Dresler P. Milo P. Šešulka V.	Oral	Magnetic Prospection of the Rampart of the Early Medieval Hill-fort Pohansko by Břeclav
Druzhinina O. Skhodnov I.	Poster	Using Methods of Palaeogeography in the Field Archaeological Prospecting
Gaffney Ch. Gaffney V. Cuttler R. Goodchild H. Kane S. Sears G.	Poster	Magnetometer Survey at the Roman Town of Cyrene, Libya
Gajdoš V. Hajach M. Pašteka R. Rozimant K.	Poster	High Resolution Magnetometry and Resistivity Imaging in Archaeological Prospecting - Case Studies from the Territory of Slovakia
Gallo D. Ciminale M. Becker H.	Oral	Highly Integrated Non-Destructive Investigation for the Reconstruction of Ancient Sites
Garbuzov G. Toločko I.V.	Poster	The Greek Colony Tanais Case Study: Integrated Prospection Approaches
Gondet S.	Oral	Multi-scaled Approaches of a Renewed Survey Program into the Plain of Persepolis (Central Fars, Iran). Did Everyone Live in Palaces During Achaemenid Times?
Haley B. S. Johnson J. K.	Poster	Mapping the Chickasaw with Integrated Magnetic Geophysics
Hašek V. Kovárník J. Peška J.	Oral	The Present State of Non-destructive Archaeological Surveing in Moravia

Haynes I. Gaffney V. Lobb M. Watters M. Wilkes S. Piro S. Zamuner D.	Poster	High-resolution Integrated Surveys in the Archaeological Site of St. John Lateran Basilica (Roma, Italy)
Henning J. Ruttkey M. Eyub E.	Oral	Geomagnetic Prospecting of the Hill-fort of Pobedim (Slovakia)
Henning J. Ruttkey M. Eyub E. Bednár P. Fotová E. Milo P. Tirpák J. Kopčeková M. Daňová K.	Oral	Archaeological Research and Geophysical Exploration at the Early Medieval Fortified Settlement in Majcichov and Other Sites
Křivánek R. Čížmář M.	Oral	The Combination of Magnetometric Prospection and Other Non-destructive Survey Methods of a Large La Tène Site Near Némčice, Central Moravia. Present Results and Future Possibilities
Piro S. Gabrielli R. Peloso D.	Oral	Integrated Surveys to Locate Chamber Tombs in the Sabine Necropolis (Rome - Italy)
Piro S.	Poster	Application of GPR Investigations in the Urban Area of Forum (Roma, Italy)
Poreba A.	Poster	Electromagnetic, GPR and Resistivity Imaging Measurements for Studying the Loess Archaeological Site of Karmanowice (Poland)
Poscetti V.	Oral	Georadar and Electrical Tomography Surveys Compared to an Old Archaeological Map (Necropolis of "Casale del Fosso" - Veio, Italy)
Tirpák J.	Oral	Geophysical Prospecting in the Slovak Archaeology
Tirpák J. Rajtár J. Matei A. Scurtu F. Varsik V.	Poster	Geophysical Prospecting in Porolissum, Romania
Trinks I. Larsson L. I. Eder-Hinterleitner A.	Oral	Mapping of Sweden's First Town Birka Using Georadar and Magnetometer Prospection
Ullrich B. Zöllner H. Makhortykh S. Orliuk M. Rolle R.	Oral	Geophysical Prospection of the Scythian Fortification of Belsk (Boľšoe Bel-skoe Gorodišče)

TOPIC 4: PROCESSING, INTERPRETATION AND VISUALISATION OF PROSPECTION DATA

Becker H. Campana S. Himmler T. Nicolosi I.	Oral	Fluxgate, Overhouser and Caesium-Magnetometry for Archaeological Prospection at Roselle-Aiali (Italy)
Berge M. A. Drahor M.G.	Oral	Electrical Resistivity Inversion Modelling Studies for Commonly Used Arrays in Höyük (Artificial Hill) Type of Archaeological Settlements

Bondar K. Virshylo I.	Poster	Archaeological Interpretation of Magnetometric Data Using 3D Magnetic Modeling Examples from Ukraine
Eppelbaum L. V.	Oral	Localization of Ring Structures in Earth Environments
Izjumov S. K. Mironov S. Gajdoš V.	Oral	Application of Georadar Method for Engineering and Geological Surveying of Historical Places
Leckebusch J. Sütterlin H.	Poster	Large Scale GPR Surveys in Augst
Leckebusch J. Weibel A. Bühler F.	Oral	Computer-assisted GPR Data Interpretation
Linford N. Linford P. Martin L. Payne A.	Oral	Geophysical Evidence for Assessing Plough Damage
Novo A. Lorenzo H. Rial F. I. Pereira M. Solla M. Arias P.	Oral	From Searching to 3D Imaging: GPR Ultra-dense Grid Methodologies
Pašteka R. Terray M. Hajach M. Pašiaková M.	Oral	Microgravity Measurements and GPR Technique in the Search for Medieval Crypts: a Case Study from St. Nicholas Church in Trnava, SW Slovakia
Sala R. Lafuente M.	Oral	Visualising the Ibero-Roman Site of Puig-Ciutat (Catalonia, Spain) from Magnetic Variation Maps and GPR Time-Slices
Schultze V. Linzen S. Schüler T. Stolz R. Chwala A. Schulz M. Meyer H.-G.	Oral	Large-scale, Fast and Sensitive Geomagnetic Archaeometry Using a SQUID-based Measurement System
Thiesson J. Tabbagh A. Dabas M.	Oral	What Are the Advantages of Several Magnetic Parameters Measurements in Prospection?

TOPIC 5: TECHNICAL ASPECTS

Hulin G. Dabas M. Tabbagh A. Tabbagh J. Thiesson J.	Poster	Feasibility of a Towed EM and Magnetic Device for Archaeological Prospecting
Křivánek R.	Poster	Possibilities and Limitations of Surveys by Caesium Magnetometers in Forested Terrains of Archaeological Sites
Tsokas G. Tsourlos P. I.	Oral	Non Destructive Ert Survey at the South Wall Of Acropolis of Athens

TOPIC 6: ARCHAEOLOGICAL FEEDBACK

Babak A.	Oral	Comparison of The Magnetic Survey and Excavation Results in Rescue Archaeological Project of Tang-e Bolaghi (Iran)
Barone P. M. Pettinelli E. Mattei E. De Santis A. De Minicis E.	Oral	GPR Investigations in the Archaeological Area of Ferento (Viterbo, Lazio, Italy)

Barta P. Bartík M. Benediková L. Ďuriš J. Pieta K. Shehab A. H. Shehab Štolc S. Tirpák J.	Oral	Geophysical Prospecting of the Bronze Age site Al-Khidr, Failaka Island, State of Kuwait
Benech Ch.	Oral	Study of Ancient City Planning With Axial Maps and Visibility Graph Analysis
Fassbinder J. W. E. Korobov D. Reinhold S. Belinskiy A. Merkulov S.	Oral	Magnetometry on Newly Discovered Bronze Age Settlements in the North Caucasus (Russia)
Fassbinder J. W. E. Berghausen K. Vogt B. Moser J.	Oral	Easter Island (Chile): Magnetometry of Archaeological Structures On Basaltic Geology
Forstner-Müller I. Herbich T. Schweitzer Ch.	Poster	Surveying Ancient Cities in the Nile Delta: the Tell el-Dabca Case
Goldmann T. Wutzler R. Mekiffer B. Wolf P. Mohamed Abdelwahab Mohamed A.	Oral	Geomagnetic Survey at the Meroitic Settlement Hamadab / Sudan
Gondet S. Benech Ch.	Poster	Understanding of the Succession of Geomagnetic Anomalies Due to a Complex Defence System: the Case of Al-Rawda (Syria)
Gorka T. Fassbinder J. W. E. Lambers K.	Poster	Magnetometry on the Geoglyphs of Palpa and Nasca (Peru)
Herbich T.	Oral	Geophysical Surveying in Egypt: Periodic Report for 2005-2006
Kaneda A. Nishimura Y. Miyake Y. Shimoda J. Nezu H.	Poster	Geophysical Survey at Tokushima Castle in Japan
Kogawa K. Kamei H. Honda M. Nagase S. Kamimura D. Shinba K.	Poster	Intergrated Geophysical Survey around Mt. Kaimondake, Japan – To Search an Original Location of Hirakiki Shrine
Pieta K. Shehab A. H. Shehab Tirpák J. Bielich M. Bartík M. Ďuriš J.	Oral	Archaeological and Geophysical Prospecting of Deserted Early Islamic Village Al-Qusur (Failaka Island, State of Kuwait)
Posselt M.	Oral	Geophysics and Excavation – Layers of Archaeological Feedback
Schmidt A. Coningham R.	Oral	Geophysical Prospection for Archaeological Investigations in South Asia
Tirpák J. Fottová E. Bartík M.	Oral	Geophysical Prospecting of Deserted Village Dolný Poltár
Trinks I. Larsson L.- I.	Oral	Geophysical Prospection and Archaeological Feedback in Rescue Archaeology – Examples from Sweden
Tsourlos P. I. Tsokas G.	Oral	Archeological Prospection by Means of Fully Non-destructive DC Resistivity Surveying

GALLIPOLI AHEAD - AIR SURVEY BETWEEN THE BALTIC AND MEDITERRANEAN

Otto Braasch

Key words: aerial archaeology, Baltic, Central Europe, Mediterranean

Anyone who flies from the German Baltic Sea coast to the Mediterranean, in order to search for archaeological traces there, would be well advised to gather experience in domestic waters. There are sufficient opportunities on offer. When the private flying prohibition in East Germany, that had lasted over 50 years, was finally waived after the fall of the Iron Curtain (*Braasch 1995*), the official Archaeological Monuments Authority in Mecklenburg-Western Pomerania under Fritz Lueth soon called for archaeological aerial survey. The intention was to expand knowledge of the existence of monuments, to document the condition and endangerment of well-known archaeological sites - on land and at sea - as well as to make good with it the considerable lack of research caused by the prohibition of flying and air photography (*Braasch 1999*). It should be said that Romania amongst other countries still forbids aerial photography officially and that Italy only waived the prohibition in the spring of 2000 - aerial archaeology in Europe still suffers from the consequences of war and a fossilized bureaucracy.

Searching in shallow water applies equally to unknown shipwrecks as well as to sunken harbour facilities, fortifications and settlement traces. Changes are documented to already known underwater monuments and possible threats to them are observed on repeated flights over a period of years. Flights are concentrated from October till June. Low sea-temperatures during this time provide acceptable visibility under water. The search applies just as much to unknown ship wrecks as to sunken harbour facilities, fortifications and settlement traces. The aims also include the lake forests, moorlands and stream meanders which have sunk into the sea over the millennia and which are also of interest to the most diverse fields of Baltic Sea research.

Airplane and equipment

The author travels as a one-man pilot and photographer in a light airplane of Cessna 172 type at flight altitudes of between 150 to 600 m. The plane is equipped as a stable photographic platform for quiet slow-speed flight over noise-sensitive beach zones with a STOL kit (Short field TakeOff and Landing kit), a 3-blade-propeller and a special silencer. The rich bird world of the coast deserves those pollution free, expensive alterations and benignly accepts the slow forward movement of the metallic species together with its considerable route planning and does not let itself be disturbed by the aircraft's size and noises. Occasionally migratory birds invite the aircraft to accompany them in autumn and spring on their way over the open sea. As a high-winged machine with hinged upward opening side windows the airplane offers ideal viewing conditions. The open windows and a roomy cabin offer ample freedom of movement to the handheld digital and analogue 35 mm cameras so that they can be positioned freely for oblique photographs. Solidly mounted cameras are not used. GPS devices and coloured electronic land and sea charts, which are adjusted automatically, help to mark position coordinates of discoveries, to store them and to display them on the screen as symbols. Thus rapid and secure navigation is made possible to the find spots. The stored coordinates and the recording time are set and evaluated after the flight together with handwritten recordings as a check list. The similarly installed autopilot heads independently to the wrecks, that have been marked by GPS on previous flights, for renewed control observation. Its assistance, above all its reliable maintaining of altitude, is no luxury over the sea with thick mist and a concealed line of horizon. The fuel supply is sufficient for more than eight hours of economical aerial survey, which permits a full working day in the air without time-consuming interruptions for landing or refuelling.

Water, sand and wind

Although the aeroplane's performance and equipment are every bit as good as required, the successful search for and documentation of underwater objects is dependent on a number of additional factors. Apart from the required clarity of the water, which is determined in the main by its temperature and thus by the proportion of plankton and suspended matter - the summer and early autumn months are therefore mostly less suitable - the condition of the sea-surface is crucial. Suspended matter from river mouths or as a consequence of strong shoreline erosion can float along the coast like smoke clouds depending upon the direction of the current and really „fog up“ long stretches of the water. Along some stretches of coast considerable sand shifting takes place under water. Particularly under the influence of winter storms this shifting can reach a thickness of up to 2.5 m and in the spring not only the marine navigation and port authorities can receive a nasty surprise when charting, marking and keeping clear channels. The

J. Stewart Aitchison, Netolice, I thank very much for translating my German text into English and I am grateful to Gabor Bertok, Pécs, who in advance provided information about the sondaging and the geophysical survey at the henge in Szemely (plate 7).
Susanne Gerhard, Schwerin, supplied data on the wooden wreck off the Darss (plate 3) for which I heartily thank her.

All Photographs taken by the author.



Fig. 1. An 80-year old legend. The Russian four-masted barque "Krusenstern" under full sail on the Baltic Sea off Arkona, Mecklenburg-Western Pomerania, Germany. Digital photo, 14th of July 2007.



Fig. 2. A journey ends off Dierhagen. The Finnish schooner "Janne" foundered during the night of 14th November 1930 just off Dierhagen village, Mecklenburg-Western Pomerania, Germany. The sand devours the wreck in the course of the years and releases it again at intervals. 30th of March 1999, Fujichrome Velvia film.



Fig. 3. Stranded and broken. A broken up Danish fishing cutter off the Darss peninsula, Mecklenburg-Western Pomerania, Germany. In the top left of the picture its stern disappears into the dark, deeper water. Winter storms distribute the wooden remains in the sand. 30th of March 1999, Fujichrome Velvia film.

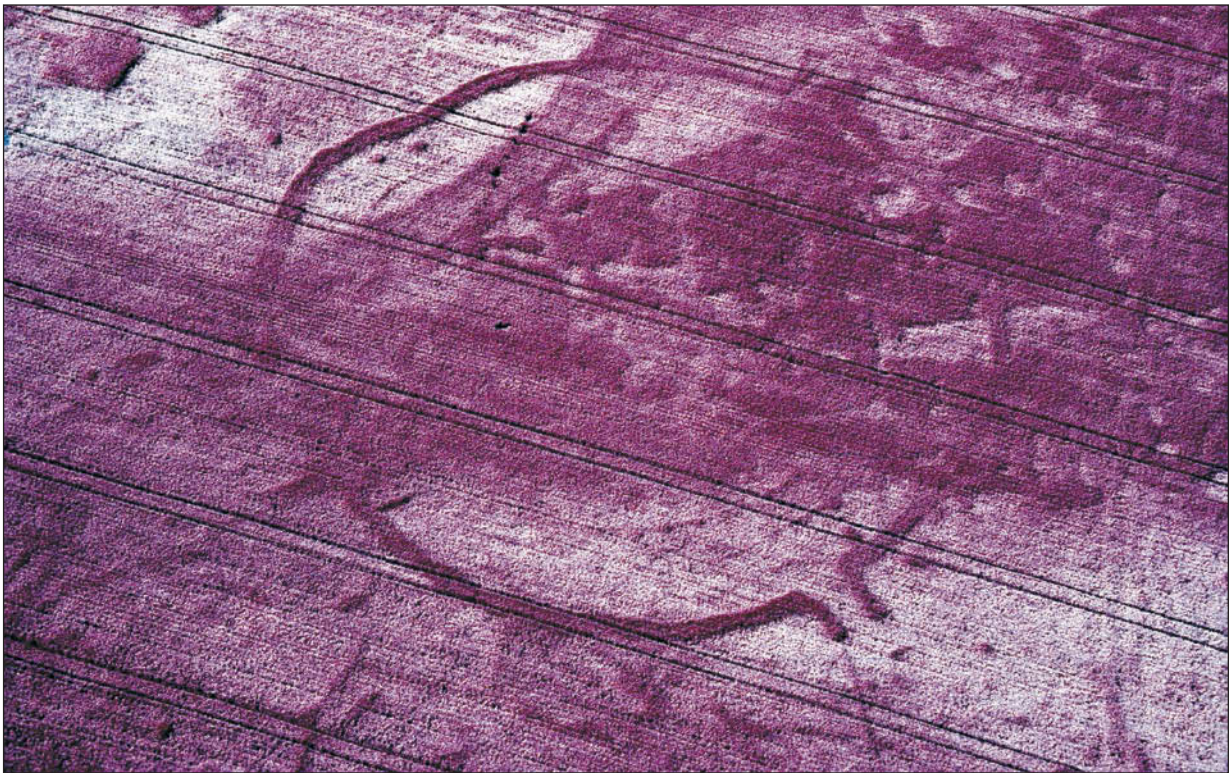

Fig. 4. Middle Neolithic in infra-red. After 50 years the sky opens for archaeological aerial survey in the east - the Middle Neolithic henge near Goseck, Weissenfels District, Saxony-Anhalt, Germany. Positive crop marks. 19th of June 1991, Kodak EIR film.

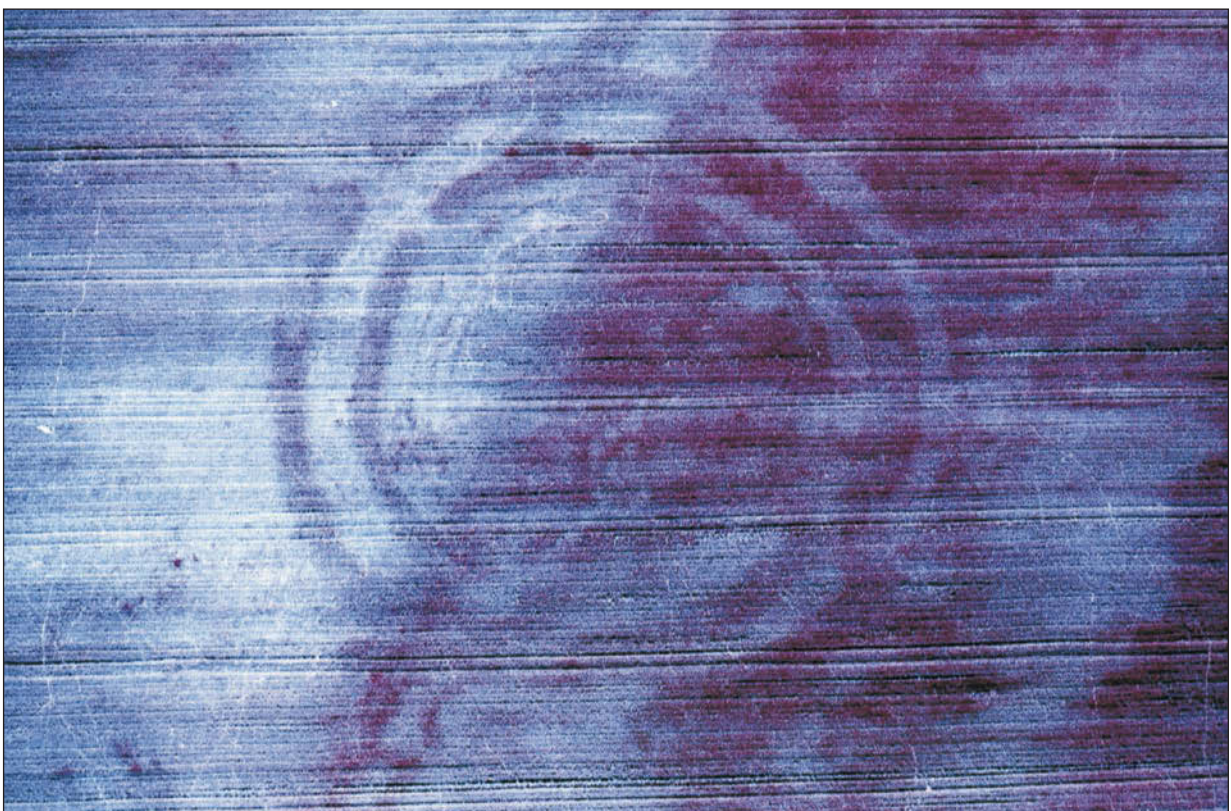

Fig. 5. Arrived in Hungary. Vegetation characteristics at the interface of positive to negative at the Ikervár henge, Antónia major corridor, Komitat Vas, Hungary. 4th of June 2002, Kodak EIR film.

sand beaches provide the airman with a new, often surprising picture each spring, depending on the storm and flow events of the winter: Recently discovered wrecks disappear, new ones suddenly emerge and „old acquaintances“ stretch out their wooden framework again from the sand after years of absence (*Braasch, in print*).

The eye and brain work with previously known examples during the search. Thus the encounter with the Russian four-masted barque “Krusenstern” encourages the imagination when sailing past the island of Ruegen (Fig. 1). Likewise, its picture helps to identify a wooden wreck off Dierhagen as a sailing ship on the basis of the shape of its hull (Fig. 2). You can also make out an eighty-year old story from the full sails of the 115 metre long four-masted sailing ship: The earlier “Padua” was built in 1926 by the J. C. Tecklenborg shipyard in Wesermuende for the Laeisz shipping company in Hamburg and it sailed as one of the “Flying p-liners” together with the “Pamir” and “Passat” in the saltpeter trade journeys to Chile and transported late wheat from Australia. The ship was delivered to the USSR as war reparations after World War II and is now a Russian naval academy school ship.

Off Dierhagen right beside the beach bathers can observe how the wreck of the Finnish three-masted schooner “Janne”, which foundered on the 14th of November 1930, is regularly buried and reexcavated in the sand by the sea over a several-year cycle. Finally we obtain an impression of the destructive forces, which can transform a wooden ship to “matchwood”, by looking at the photograph of the wreck on the west coast of the Darss peninsula (Fig. 3). With the proud “Krusenstern” before your eyes your thoughts can wander from the sight of the scattered, pitiful rubble to the sailors, whose cutter came to such a disastrous end off the Darss. Thus curiosity for the past and a healthy imagination provide effective motivation for the aerial survey - over land and sea.

A steady wind starting from 5 knots in strength produces waves with such reflections and mirroring within two hours that even with the use of polarisation filters to reduce them the search in deeper layers becomes practically impossible. Therefore low wind high pressure weather conditions with weak pressure gradients and the morning hours in general are ideal for aerial work over the sea before the onset of disturbing local sea and land winds which occur during the course of the day. Therefore obtaining of longer term weather forecasts is a routine part of flight planning - and a due portion of patience, particularly if the local weather God transforms the best forecast into its opposite.



Fig. 6. A henge prompts questions. Comparative photo of the site of Ikervár after 5 years in natural colours. Digital photo, 14th of June 2007.

Eyes and Patience

The aerial survey takes place exclusively with the naked eye, which undertakes the main burden of the aerial work as a flexible "biological sensor". While the pilot and photographer recognize traces, identify them and interpret them on an ad hoc basis, camera and film only provide the recording. Sites are not discovered "in" or "with the aerial photograph" during these aerial surveys - as even archaeologists often thoughtlessly and erroneously write under the influence of the anonymity of the authoritative picture - but by the observer in the aeroplane. The German expression "Luftbildarchaeologie" (aerial photographic archaeology) encourages this misunderstanding.

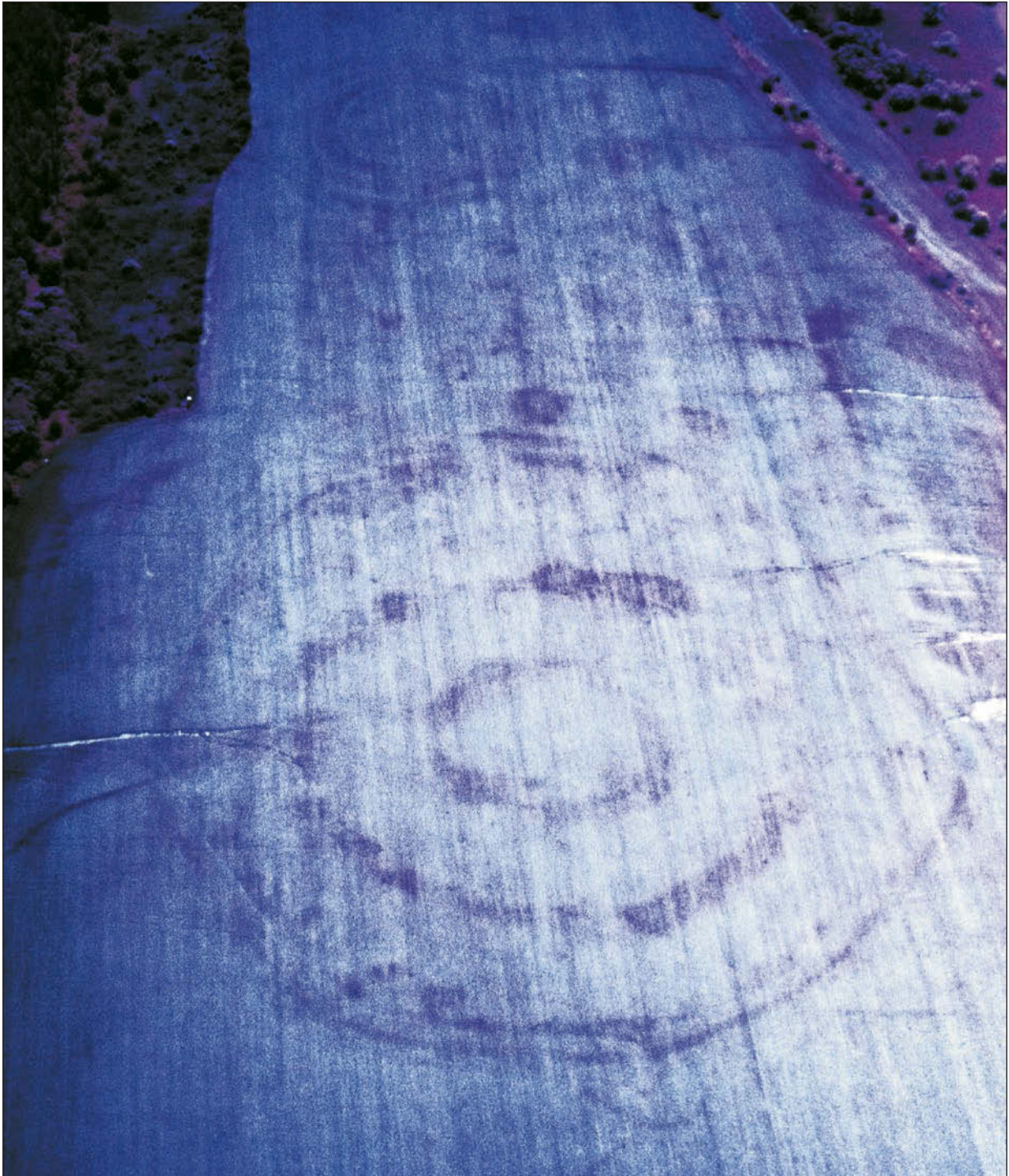

Fig. 7. Monumental Lengyel culture. The largest Neolithic henge in Europe so far is situated on a loess tongue in South-west Hungary. Szemely, Hegyes corridor, Komitat Baranya, Hungary. Positive vegetation characteristics with erosion gulleys. Discovery photo, 12th of June 2003, Kodak EIR film.

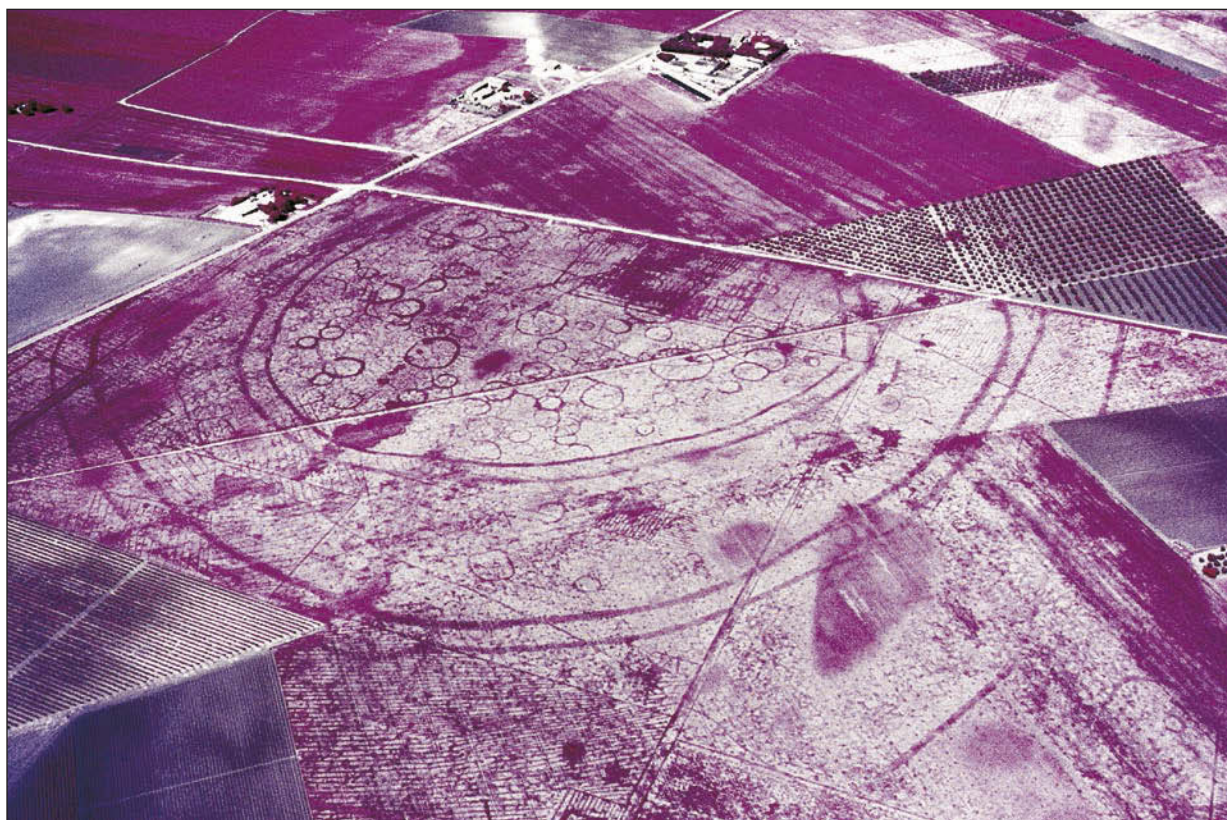

Fig. 8. Ancient Apulia. A Neolithic ditch work with house foundations appears under a complex Roman agrarian corridor in Tavoliere. Palmori, Foggia province, Puglia Region, Italia. 22nd of May 2005, Kodak EIR film.

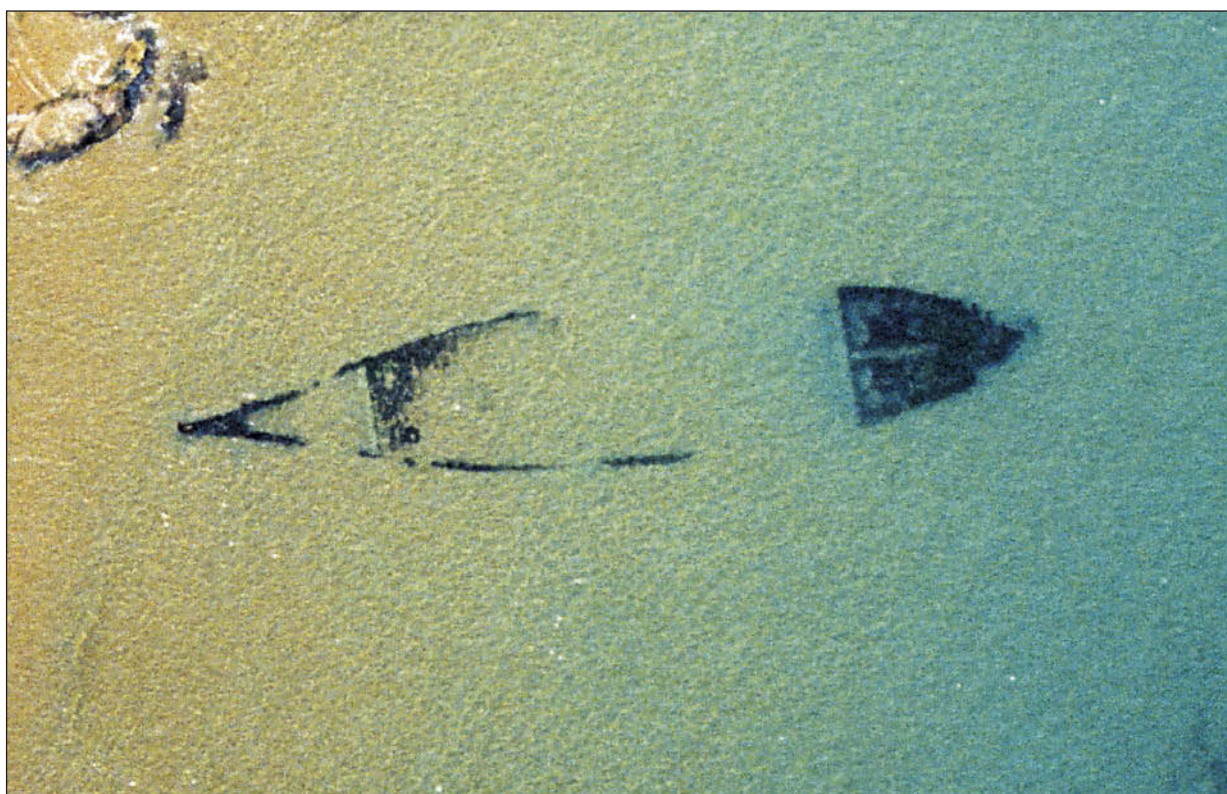

Fig. 9. In front of the harbour. The slim wooden wreck of a sailing ship lies half buried in the sand with the bow pointing towards the beach. Vieste del Gargano, Foggia Province, Puglia Region, Italia. Digital photo, 30th of May 2003.



Fig. 10. Sunken remains. Massive stone tablets mark the remains of a harbour facility under water off the west coast of Salento. Porto Cesareo, Lecce Province, Puglia Region, Italia. Digital photo, 24th of May 2006.



Fig. 11. Gallipoli, Greek foundation on the Ionian Sea. View of a Mediterranean port with a long, eventful history. Gallipoli, Lecce Province, Puglia Region, Italy. Digital photo, 24th of May 2006.

We are however not dealing with the search for archaeological traces in vertical photographic images or in satellite photos, like Google-Earth offers.

Under favourable conditions larger objects in the Baltic Sea can be made out and identified up to a depth of approximately 6 metres. However bright sandy sea-soil is then necessary, so that dark outlines can appear at all clearly enough as wreck or harbour traces. A darker, usually rocky seabed makes the search more difficult just like regular deposits of dark sinking material, which together with sand can form a dune-like underwater landscape. Occasionally swarms of fish - as long as they remain still - fool the aviator as a grey shadow. If you keep your eye on these suspicious features for long enough it can happen that the alleged wrecks transform themselves into groups of wandering animals which shoot away as amorphous shadows on the approach of cormorants, carnivorous fish or hunting seals. As is the case with waiting for suitable weather, perseverance and patience are required for the search: finds often remain unclear and unconfirmed for a long time. And sometimes it takes years until traces can be confirmed with any degree of certainty from the air. Then diving archaeologists are required for final clarification. Access to historical sources, like maps and writings and looking into navigation history and historical ship types is also helpful. Constant information exchange with an intact and flexible Archaeological Monuments Service and close co-operation with inventory and research workers are a requirement for aerial survey both on land and along the coast. These tools for the broad and comprehensive acquisition of information hold the key to success. The actual craftsmanship in the air appears comparatively simple in contrast, the keywords here are "information management" (*Braasch 1983*).

Camera and Film

Apart from a few characteristics the photographic equipment for the work over the sea corresponds to the tried and tested set-up for flights over land. And for as long as the Archaeological Monument authorities do not have a system for the safe long-term archiving of digital photographic data, work will continue with analogue films. Analogue 35mm cameras with the following set of features that enable rapid deployment have proved their worth to the "one-handed flier" who carries out the tasks of pilot, observer and photographer:

- single lens reflex cameras (SLR) featuring automatic bracketing at a robust version for professional employment;
- automatic film transport including rewinding;
- insertion of exposure data, if possible, in the film bar between photographs.

Professional cameras with their large number of mechanical and electronic components operate for more than 400 films without breakdown in 2007 whereas in 1983 the average was only at 150 films. Between 40 and 60 photographs are taken per flying hour. At the beginning high-quality, strong light adjustable lenses with focal lengths of between 50 to 200 mm worked satisfactorily. In the meantime they have been increasingly replaced by zoom lenses with image stabilizers to avoid blurring through movement. Automatic focussing is also increasingly used. Both types of mechanism have been subject to constant improvements in the course of the years and these days they permit work with longer exposure times with an acceptable rate of occasional out of focus pictures. In the case of long focal lengths this is usually to be put down to the failure of the automatic focus when photographing underwater and land objects with extremely low contrast, where the automatic focus is pushed to its present limits. A remedy is provided by manual focussing which however requires some practice in the case of underwater objects with telescopic lenses.

The previously often mentioned restrictions on small display format regarding magnification and reproduction of detail have long been compensated for in relation to the larger medium or aerial photograph formats through the use of fine-grained films with higher resolution. These films however are less sensitive, they are "slow". The shutter speeds however have to be kept as short as possible because of the danger of blurring through engine vibrations of the plane and by gusts of wind. As a result of this the lens is required to fulfil a standard which can only be achieved at great expense i.e. it has to have a large initial opening with good contrast and high resolution at the same time. Picture stabilizers can reduce the shutter speed problem, but they cannot banish it completely. Thus the choice of lens retains a key role for the quality of the picture results. In the following list of priorities, which was set up for the selection of complete camera equipment, the optics therefore also appear in first place:

1. High resolution already during the initial opening of the lens;
2. High reliability and a small error rate;
3. Simple and fast operability;
4. Little danger of making a mistake when aiming and operating;
5. Compact dimensions and light weight.

While the requirements for lenses and cameras are generally fulfilled by several makes such as Canon, Contax and Nikon with their lenses, only a few of the exclusively used colour slide and monochrome photographic films come into consideration for the specialized work over the sea. In the case of black and white films the Kodak Technical Pan film 2415 was the leader for 20 years. However it has not been manufactured since 2006 and as the last supplies are running out it is necessary to find a replacement. With a theoretical dissolution of a maximum of 400 lines per millimetre and variable sensitivity, which in the case with low-contrast objects, such as underwater targets, can be increased up to 100 ASA, the Technical Pan Film supplies excellent results. Photographs with this film, which was originally created for astronomical photography, can be magnified to an almost unlimited extent.

In the case of colour slide films after the cessation of production of the „slow“ archive reliable Kodachrome 25 which had only 25 ASA - which only permitted the employment of fast lenses with focal lengths of 50-90 mm - Ko-

dachrome 64 and Fujichrome Velvia 50 as well as Fujichrome Velvia RVP 100 have been used. Because polarisation filters greatly reduce the available light, the achievement of sufficiently short shutter speeds in the case of a dark water background remains critical even when employing Velvia RVP 100 at 100 ASA. The deeper-lying stern of the large wreck off the Darss, which has already broken into pieces, is already a headache during exposure and details can therefore scarcely be made out there now (Fig. 3). The sensitivity of the Velvia RVP 100 can however be pushed to 200 ASA and higher through adapted development with little loss of quality. There is no quick fix for analogue photography with high resolution, when targets lie so deep in the water that their weak outlines only appear blurred even under optimum conditions. Here digital photography with almost arbitrarily high ASA values in combination with image stabilizers followed by image processing on the computer provides some remedy. It is also therefore to be wished that digital archaeological photographic data will very soon be able to be entrusted to a reliable, long-term safe archiving system.

For longer air journeys over land to the Mediterranean the film assortment is completed by an exotic candidate: Kodak Ektachrome Professional Infrared EIR film (Kodak 2005). It is also known as false-colour film and first French archaeologists have been experimenting with it on an individual basis since the 1960s. This particular type of film was originally invented in the USA for military aerial photography.

Roger Agache was the first archaeologist to report about it in 1968 (Agache 1968). He was followed by Daniel Jalmain in 1970, who amongst other things demonstrated through example the special suitability of the film for the clearer rendition of soil dampness (Jalmain 1970). In 1973 the French magazine *Archeologia* appeared with exciting infrared aerial photographs and dedicated a complete edition to archaeological aerial photography. In the journal Rene Goguet, Jacques Dassié and Maurice Marsac compared infrared photographs with aerial photographs with conventional colour and black and white films (*Archeologia* 1973). In 1975 then an essay by Jack Rinker in a respected CBA Research report on the suitability of special film emulsions for the interpretation of aerial photographs provided the impulse for others to make use of this special type of film (Rinker 1975). He certified the EIR film's special suitability for the representation of soil dampness, water, bank lines, shadow edges, foliage green and lawns. Through the nearly complete darkening of shadows the film brings out even the weakest surface relief at low sunlight. Thus traces which can only be made out by the eye with difficulty, like flattened grave mounds, can still be documented with sufficient clarity. The employed yellow and orange filters block portions of the blue light and let the film better penetrate dry mist, which in addition can be advantageous for landscape photography over greater distances.

The characteristics listed by Rinker, like the strong differentiation in colour between healthy and withering foliage, which has great importance for the representation and interpretation of vegetation characteristics, are only demonstrated by the film when it is developed using the original AR-5 process. At the time of writing the film is only to be obtained from specialist outlets with a relatively long delivery period. It is therefore recommended to order it in the USA where it is professionally developed in good quality. Because analogue camera exposure meters that are adjusted to daylight do not use the infrared portion of the light spectrum that is registered by the film, the exposure is critical. Automatic exposure bracketing provides help. It is adjusted with changing intermediate stages in cases of difficult lighting. It should also be noted that the proportion of infrared varies dependent on cloud cover and the position of the sun - so the infrared proportion is greatest in the morning and in the evening. It is also therefore recommended to extend the exposure sequence in both directions from the measured initial value for important photographs. Cloud shadows are to be avoided absolutely, shadows almost totally blacken the infrared film - other than a normally sensitised film, which records the blue light proportion in the shadow. For 30 years the author has used the EIR film - in addition to the usual black-and-white and colour slide materials - for special targets such like Neolithic henges. In the summer of 1970 John Hampton had already carried out a test series with different kinds of film already to document vegetation characteristics in the South of England and amongst other things he reported the result as: "... Colour is useful in the experimental stages as a measure of crop conditions. Subsequently it seems likely that two cameras, one with panchromatic and the other with FCIR (False Colour InfraRed) would record most of the anomalies. If separation printing from Kodak type 2443 FCIR continues to show the advantages found in this limited experiment, it may be that one camera loaded with this film is adequate. Clearly this is an area for further work but the importance of sunlight in the use of this film should be noted as a limiting factor" (Hampton 1974). The EIR film will present some places of discovery on our route to Gallipoli.

Southbound

On a southerly course the plane carries us from the Baltic coast to Goseck (Fig. 4) in Saxony-Anhalt, where archaeological air survey started after the political changes on the 17th of May 1991. Already on the 11th of June 1991 the first Middle Neolithic henge came to light (Braasch/Kaufmann 1992).

The annual precipitation in East Germany is on average 200 mm below that of West Germany, which regularly leads to a higher soil water deficit in the vegetation period. Over many years in the east precipitation averaged between 250 to 350 mm in the crucial period for the development of crop marks from April to September (Hanke 1991). Survey results are accordingly favourable and in addition they are based on larger field units in comparison with the west (Schwarz 2003). The Goseck henge with a simple ditch, three pincer gates with outwardly facing cheeks and two palisade rings, was discovered due to positive crop marks, which betrayed themselves in the picture by greater height growth and more intensive colouring. After its excavation, which began in 2002, the henge was restored in a media-friendly way from 2005. With archaeological tours and torch lit processions including a fire spectacle on

the occasion of the Winter Solstice it attracts numerous visitors as an example of "Event archaeology" (Meller 2007). Ralf Schwarz took aerial photographs of the site for the cover and the back of his pioneering monograph about archaeological aerial photography in Saxony-Anhalt and underlined the central location character of the sites with reference to three of the ditches leading off from the gates as possible boundaries between settlement or economic areas (Schwarz 2003). In doing so he referred to the condition for the central location components of henges as formulated by Gerhard Trnka (Trnka 1991).

Over Pannonia

The aerial journey continues through the henge rich landscapes of Moravia, Lower Austria and Western Slovakia - which are known to be centres of the Lengyel culture - to Hungary (Petrasch 1990; Kuzma 2004; Meyer/Raetzell/Fabian 2006).

There in Pannonia in the valley of the Rába we came across a classical henge with a double ditch and three narrow palisade rings on the inside on the 4th of June 2002 near Ikervár (Fig. 5) in Komitat Vas (Braasch 2003). Its outer diameter can be estimated by comparison with tractor tracks to 55-65 m. So far only one gate can be recognized with certainty. In the past the river obviously had washed a layer of humus onto the site into which the henge was half dug. This gives a stronger and later green layer to the cereals and the covering layer of humus and therefore lends it a darker red colour on the EIR film. The ditches appear to us there as bright vegetation features on account of the darker surrounding area, although their original colour tone from the left half of the picture is unchanged where they are considered to be positive crop marks. Wandering wildlife has left its traces as narrow bright ridges in the wheat. A digital comparative photograph in natural colours from the 14th of June 2007 betrays amongst other things the now partial dissolution of the palisade ditches into countable post pits and the planting of grain that visibly reduces the traces of soil interference to a greater extent than the vegetation in 2002 (Fig. 6).

Questions about the complex interaction of archaeological soil disturbance and field plants that still await an answer lie behind this change and also in the influence of the postulated covering layer of humus which appears here in natural dark green. They arouse however little interest in the guild of field archaeologists. Literature on the topic of crop marks meanwhile dates a long way back into the past century (Strunk-Lichtenberg 1965; Jones/Evans 1975). It remains to be wished that the investigations undertaken by J. Fassbinder and H. Stanjek in Bavaria on this group of topics will be continued and that also the phenomenon of rather exotic moisture and snow marks will be more thoroughly examined (Stanjek/Fassbinder 1996).

The discovery photo of the "mother of henges" was taken on the 12th of June 2003 near Szemely in the Komitat of Baranya (Fig. 7). The site lies to the south of Pécs on loess near the border with Croatia. In the photo an enormous circular ditch enclosure with four washed out dark traces of ditches in a wheat field fills out the centre of the picture. Fresh, bright erosion gulleys that have been dug out by heavy rain eat into the monument from its edges. The outermost pair of ditches forms a slightly irregular oval. In the background a second henge appears in the upper edge of the picture. According to Gabor Bertok, archaeologist at the Museum of the Baranya Komitat, the results of an initial excavation which cut trenches of 240 and 140 m in length and a magnetometer survey which was carried out by Mihaly Pethe in 2006 can be summarized as follows: The finds date the complex to the Lengyel culture. The internal complex of circular ditches consists of 5 single ditches with 4 gates. The greatest ditch depths lie between 3.5 and 4.0 m. The middle V-shaped ditch has a diameter of 200 m. It is 2.5 to 3.0 m in depth and likewise has 4 gates. The outside double ditch visible in the aerial photograph proved during the field investigation to be an oval complex of ditches with a diameter of 400-450 m. It consists of 3 to 5 individual, V-shaped ditches of differing depths from 1.5 to 2.5 meters. The four gates are arranged into a complex with several protruding ditch sections. A further ditch also runs from the outermost ring ditch in a southerly direction towards the smaller henge at the upper edge of the photograph (Bertók/Gáti/Vajda 2007; Pethe in print).

With its outer diameter of 400-450 m the henge is almost twice as big as the largest previously known sites of this type. It thereby corresponds approximately to the dimensions of the enormous prehistoric monuments of Avebury and Durrington in the English county of Wiltshire. The discovery of Szemely may give further impetus to aerial survey in Hungary, whose rich archaeological landscapes along the Danube and Theiss quickly opened to aerial survey after 1989. Both Szemely henges together with a further group of such sites nearby strengthen the assumption that the distribution area of the Middle Neolithic circular ditched enclosures extended even further down the Danube. Do regional forms and influences of the henge rich Lengyel culture extend into the north of Croatia as Tihomila Tezak Gregl reported in 1999 (Tezak/Gregl 1999)? It would be easier to confirm this supposition if the southern Danube countries would finally allow their archaeologists to undertake free flying and photography after the end of communism and the Balkan wars.

Over Apulia

From Hungary the course leads across Croatia over the Adriatic to the South of Italy. Here in Apulia the eye can expect to see a veritable paradise of archaeological remains from the air (Riley 1992). The flat landscape of the Tavoliera spreads out around Foggia, which with a hardpan-like, hard sinter layer, the „crosta“ at depths of 30 to 60 cm, provides ideal conditions particularly for the forming of positive crop marks. All examples of soil disturbance, which broke through the „crosta“, remain stored in it to this day and allow suitable field plants to trace the breakthroughs

with their root work. In the case of a lack of moisture this leads to extremely clear and sharply defined differences in height and in the foliage index between plants that live over the layer and those disadvantaged ones that take root beside a hole in the layer. John Bradford was the first archaeologist to report in detail about the Tavoliere and its potential for aerial survey (*Bradford 1957*). The oblique photograph in the Palmori corridor (Fig. 8) in the north of Foggia was taken on the 22nd of May 2005. It shows how in large modern fields a regionally typical monumental Neolithic ditched enclosure with its round house ground plans is overlain by a classical Roman centuriation. From the foreground of the picture up to and beyond the middle the ancient traces dominate the image and in the cornfield they even superimpose themselves over contemporary traces of soil working. Here aerial survey demonstrates its strength as an ideal tool of landscape archaeology. The archaeological treasures of the Tavoliere however are shrinking constantly: Since 2005 wind parks with cable ditches and concrete foundations have destroyed archaeological monuments in the ground and the deep cultivation of wine, lemon and olives has been replacing the more careful and archaeologically compatible cultivation of grain. Traces of such encroaching, deep destructive cultivation show in the bottom left and top right of the photograph (*Musson/Campagna 2005; Romano/Volpe 2005*).

On the east coast of Apulia on the Gargano Massif off the port of Vieste a wooden wreck betrays itself as a Mediterranean sailing ship through its elegant outline - a design of ship which is a rare guest in the Baltic (Fig. 9). The bright light in southern latitudes facilitates the underwater search.

Finally we have reached the Salento peninsula on the Italian boot, where on the 24th of May 2006 we noticed massive foundation tablets in the crystal clear water of the Ionian Sea in front of the entrance to Porto Cesareo (Fig. 10). Arranged in a double arc they may indicate a harbour fortification which the Staufers or the Anjou established. After a further 24 km the destination of Gallipoli appears on the horizon - a port and fortified town in an ideal situation and of Greek origin (Fig. 11). It was conquered in 265 B.C. by Rome and afterwards suffered an eventful history. Sieges and conquests by the Vandals and Byzantines, the Normans, the Anjou, Venetians, Spaniards and French, allow us to hope to find ships in the area. Conditions for sea sightings seem to be suitable for future endeavours, in places there is even contrast supporting bright sand on the sea bed, which would offer ideal prospects for future aerial survey.

BIBLIOGRAPHY

- | | |
|-----------------------------------|--|
| <i>Agache 1968</i> | R. Agache: Essai d'utilisation aérienne et au sol d'émulsions spectrozonales, dites 'infra-rouges couleurs'. C.R.S. Soc. Prehist. Fr., 1968, 198-201. |
| <i>Archeologia 1973</i> | Archeologia: L'Archéologie Aérienne: Vision Fantastique du Passé. Document Archéologie Aérienne 1973/1. Paris 1973 |
| <i>Goguey 1973</i> | R. Goguey: Quatorze années d'archéologie aérienne en Bourgogne. Dossiers de l'Archéologie 1, 1973, 32-39. |
| <i>Dassié 1973</i> | J. Dassié: Archéologie aérienne en Charente-Maritime: découverte de la protohistoire saintongeaise. Dossiers de l'Archéologie 1, 1973, 46-57. |
| <i>Marsac 1973</i> | M. Marsac: Recherches archéologiques aériennes autour de l'ancien golfe des Pictons. Dossiers de l'Archéologie 1, 1973, 58-66. |
| <i>Bertók/Gáti/Vajda in print</i> | G. Bertók/Cs. Gáti/O. Vajda: Preliminary Report on the Research at the Neolithic Kreisgrabenanlage at Szemely-Hegyves, Baranya County, Hungary. Archaeológiai Értesítő in print. |
| <i>Bradford 1957</i> | J. S. P. Bradford: Ancient Landscapes. Studies in Field Archaeology. 1957. |
| <i>Braasch 1983</i> | O. Braasch: Luftbildarchäologie in Süddeutschland. In: Kleine Schriften zur römischen Besetzungsgeschichte Südwestdeutschlands 30, 1983, 56. |
| <i>Braasch/Kaufmann 1992</i> | O. Braasch/D. Kaufmann: Zum Beginn archäologischer Flugprospektion in Sachsen-Anhalt. In: Ausgrabungen und Funde 37, 1992, 186-205. |
| <i>Braasch 1995</i> | O. Braasch: 50 Jahre verloren. Forschungen zur Archäologie im Land Brandenburg 3, 1995. |
| <i>Braasch 1999</i> | O. Braasch: Luftbildarchäologie - archäologisch-historische Flugprospektion. In: Luftbild-Archäologie in Mecklenburg-Vorpommern. Katalog zur Ausstellung im Kulturhistorischen Museum Rostock und im Regionalmuseum Neubrandenburg. Neubrandenburg 1999, 4-13. |
| <i>Braasch 2003</i> | O. Braasch: Die Donau hinab - archäologische Flüge in Ungarn. In: Régészeti Múemlékek Kutatása és Gondozása a 3. Évezred Küszöbén. Pécs 2003, 41-65. |
| <i>Braasch in print</i> | O. Braasch: Baltic Air Survey. In: Seminar Report, Where the Land Meets the Sea. Seminar and workshop on maritime landscapes and aerial archaeology, Tallinn and Saaremaa, Estonia, October 26-29, 2006 in print. |
| <i>Hampton 1974</i> | J. N. Hampton: An Experiment in Multispectral Air Photography for Archaeological Research. In: Photogrammetric Record 8, 1974, 37-64. |
| <i>Hanke 1991</i> | G. Hanke: Wasser für die Pflanze, Berlin, 1991, 20. |
| <i>Jalmain 1970</i> | D. Jalmain: Archéologie aérienne en Ile-de-France, Baucé Brie, Champagne. Paris, Editions Technip 1970, 8-10. |
| <i>Jones/Evans 1975</i> | R. J. A. Jones/R. Evans: Soil and crop marks in the recognition of archaeological sites by air photography. In: D. R. Wilson (ed): Aerial reconnaissance for archaeology. CBA Research Report 12, London 1975, 1-11. |
| <i>Kodak 2005</i> | Kodak Technical Data: Kodak Professional Infrared EIR Film - TI-2323, 2005. |
| <i>Kuzma 2004</i> | I. Kuzma: Neolithische Kreisgrabenanlagen in der Slowakei. Abstract at International Workshop in Goseck (Saxony-Anhalt, Germany) May 2004. www.praehist.uni-halle.de/workshop.pdf |

- Meller 2007* H. Meller: Archäologie als Sensation - Umgang mit großen archäologischen Entdeckungen im Spannungsfeld von Wissenschaft, Medien und Eventkultur. Vortrag zur Jahrestagung 2007 der Vereinigung der Landesdenkmalpfleger und des Verbandes der Landesarchäologen in der Bundesrepublik Deutschland, Esslingen, 9-13. Juni 2007.
- Meyer/Raetzl-Fabian 2006* M. Meyer/D. Raetzl-Fabian: Neolithische Grabenwerke in Mitteleuropa. Ein Überblick. jungsteinSITE 2006. www.junsteinSITE.de
- Musson/Campana 2005* C. Musson/S. Campana: Fotografare i segni di passato. In: C. Musson/R. Palmer/S. Campana: In volo nel passato. Aerofotografia e cartografia archeologica. Siena 2005, 172-229.
- Pethe in print* M. Pethe: On the geophysical methods applied at the Szemely Hegyes Archaeological site In: G. Bertók/Cs. Gáti/O. Vajda: Preliminary Report on the Research at the Neolithic Kreisgrabenanlage at Szemely-Hegyes, Baranya County, Hungary. *Archaeológiai Ertesítő*, in print.
- Petrasch 1990* J. Petrasch: Mittelneolithische Kreisgrabenanlagen in Mitteleuropa, Ber. RGK Komm 71, 1990.
- Riley 1992* D. N. Riley: New aerial reconnaissance in Apulia. In: *Papers of the British School at Rome*, LX, 1992, 291-307.
- Rinker 1975* J. N. Rinker: Some technical aspects of film emulsions in relation to the analysis and interpretation of aerial photographs. In: *Aerial reconnaissance for archaeology*. CBA Research Report No. 12, 1975, 32-46.
- Romano/Volpe 2005* A. V. Romano/G. Volpe: Paesaggi e insediamenti rurali nel comprensorio del Celone fra Tardoantico e Altomedioevo. In: *Paesaggi e insediamenti rurali in Italia Meridionale fra Tardoantico e Altomedioevo*. Bari 2005, 241-259.
- Schwarz 2003* R. Schwarz: Pilotstudien - 12 Jahre Luftbildarchäologie in Sachsen-Anhalt. 2003.
- Stanjek/Fassbinder 1996* H. Stanjek/J. Fassbinder: Bodenkundliche Untersuchungen zum Verständnis archäologischer Strukturen im Luftbild. In: *Arbeitshefte des Bayerischen Landesamtes für Denkmalpflege* 59, 1996, 249-255.
- Strunk-Lichtenberg 1965* G. Strunk/Lichtenberg: Bodenkundliche Untersuchungen an archäologischen Objekten, die durch Luftaufnahmen entdeckt wurden. *Archaeo-Physika* 1, 1965, 175 ff.
- Tezak-Gregl 1999* T. Tezak-Gregl: The Lengyel Culture in Croatia. In: *Abstracts at Lengyel '99 - 2nd Workshop Meeting of IGCP-442 (11-13 October, 1999, Veszprém, Hungary)*. www.ace.hu/igcp442/ws2/tezak.html
- Trnka 1991* G. Trnka: Studien zu mittelneolithischen Kreisgrabenanlagen. *Mitt. Prähist. Komm. Österr. Akad. Wiss.* 26, 1991.

Otto Braasch
Mathais -Hoesl. Str. 6
840 34 Landshut
otto.braasch@landshut.org

CIRCULAR ARCHAEOLOGICAL SURVEY BASED ON THE GIS AT THE SIKIRYOU-SITE, KAGOSHIMA, JAPAN

Takayuki Ako - Hiroyuki Kamei

Key words: GIS, archaeological database, data integration

Application of the GIS in archaeology is now classified as follows:

- Management of archaeological resources
- GIS and excavation
- Landscape archaeology
- Spatial and simulation modelling (Conolly/Lake 2006)

Spatial analysis developed the existing archaeological research greatly. However, there are few examples in the management of archaeological resources. A system of archaeological survey carried out by researchers in various

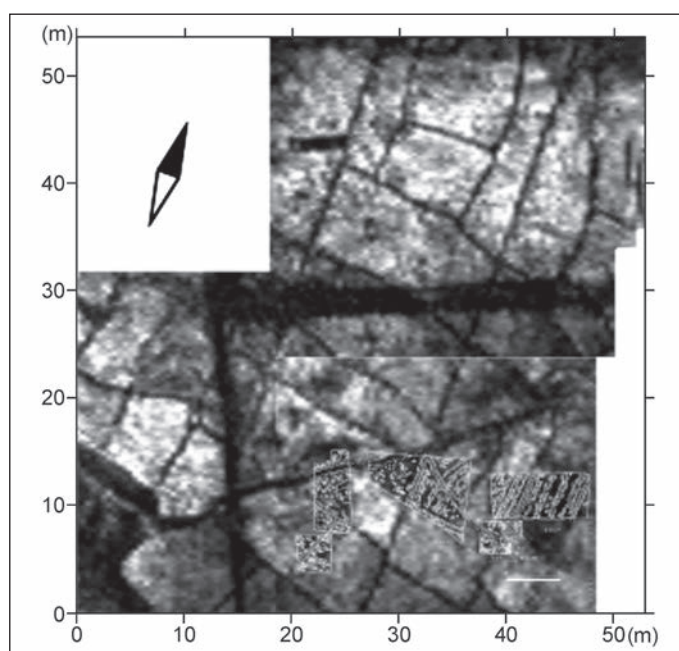

Fig. 1. The GPR time-slice.



Fig. 2. The result of excavation (the paddy field).

fields has not been established. In addition, most of the research results by using the GIS techniques come not from the investigations of the same periods.

Archaeological survey usually does not end with only single survey such as archaeological prospection, excavation, analysis etc. Archaeological facts are accumulated by several surveys, and a new archaeological theory is derived from the accumulated facts.

All results from several surveys should be integrated. Archaeological information of the surveys has positional information. A document about archaeological survey can exchange links with all archaeological information, not to mention result of prospection and excavation, via the positional information. So, the authors propose the method of archaeological survey based on the GIS. This method integrates results from several surveys for multiple periods.

In this research, the authors will describe the proposed method through the example of archaeological survey at Sikiryou-site, Kagoshima, Japan. For some excavations, the remains of many paddy fields in medieval period had been excavated in Sikiryou site. Since 2005, archaeological prospection and excavation have been carried out repeatedly. Fig. 1 shows the GPR time-slice in March 2005. We can see many lines in the GPR time-slice, but we cannot determine what these lines are. Fortunately, our survey team had the results from the previous excavation in the area of GPR survey. As a result, our team determined that these lines are paths between paddy fields by comparing the result of the GPR survey to excavation. It became easy to set an area of excavation by using the GPR time-slice, and our team could excavate two complete paddy fields for the first time on this site (Fig. 2). In addition, a historian found the parallel paths running north-south by integrating all results of surveys on the GIS (Fig. 3). He thinks that these parallel paths prove the social system of the period.

Our team constructed the below cycle of archaeological survey through the survey of this site.

- Estimation of the underground structure by archaeological prospection
- Excavation based on the result of the prospection
- Understanding the past by the accumulated archaeological facts

The present cycle is the third time all researchers of our team can be sharing equally the results. The circular archaeological survey based on the GIS will become a mainstream of archaeological survey. We must discuss how to share a wide variety of results.

This study is supported by the 21st century COE program, COE-LKR, at the Tokyo Institute of Technology, J06 and Ministry of Education, Science, Sports and Culture, Grant-in-Aid for Scientific Research, Grant number 16089206.

REFERENCES

Conolly/Lake 2006

J. Conolly/M. Lake: Geographical Information Systems in Archaeology, Cambridge, 2006.

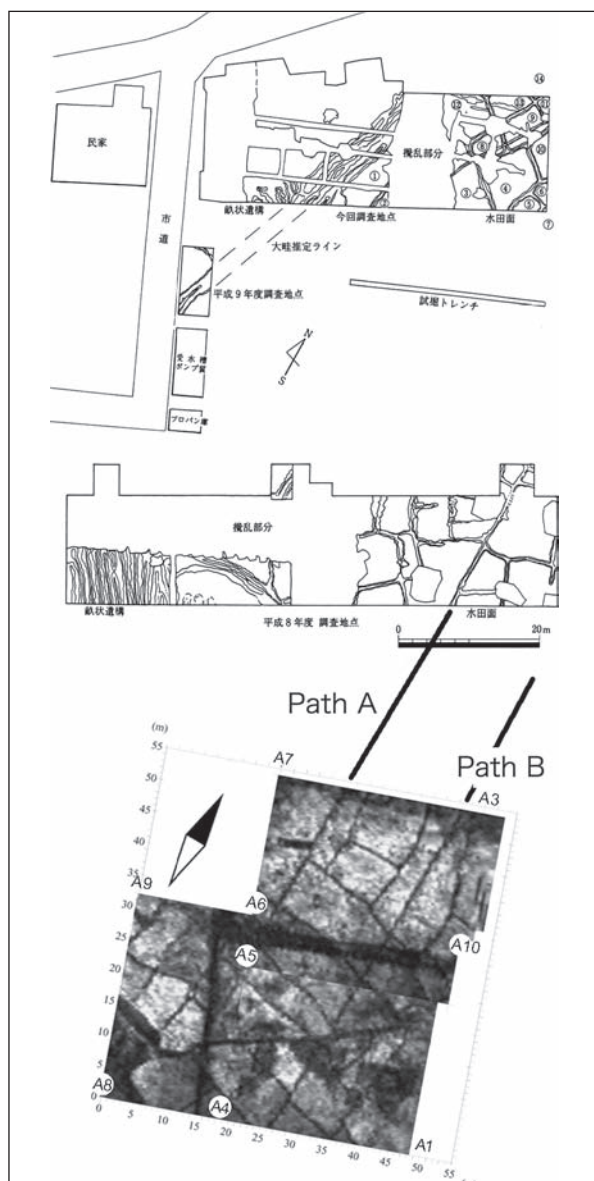

Fig. 3. The integration of the several results.

Takayuki Ako
Hiroyuki Kamei
Tokyo Institute of Technology
2-12-1-W8-72 O-okayama, Meguro, Tokyo, 152-8552, Japan
ako@archaeo.cs.titech.ac.jp
kamei@archaeo.cs.titech.ac.jp

COMPARISON OF THE MAGNETIC SURVEY AND EXCAVATION RESULTS IN RESCUE ARCHAEOLOGICAL PROJECT OF TANG-E BOLAGHI (IRAN)

Babak Aminpour

Key words: magnetic survey, Tang-e Bolaghi, Pasargadae, rescue archaeology, Sivand dam

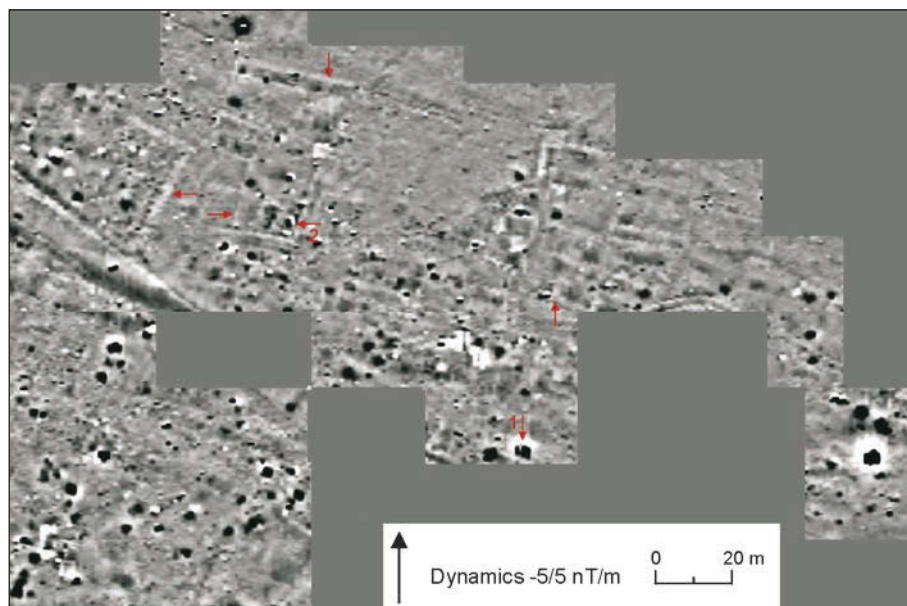

Fig. 1. Magnetic gradient anomaly map of site 64 in Tang-e Bolaghi.



Fig. 2. Excavated structure related to wine production in site 64.

Tang-e Bolaghi valley is located north of Fars province and 5 km southeast of the important archaeological area, Pasargadae. As the construction of a dam over the river Pulvar threatens the whole valley, which contains lots of archaeological sites of various sizes and periods, the international rescue archaeological researches have been done behind the reservoir of the dam.

Some settlement sites were revealed during preliminary archaeological expeditions. Some of the more important parts were studied in detail by magnetic survey and excavation. The magnetic survey is related to two settlement sites named "64" and "131", which have been excavated by a joint Iranian-Polish and Iranian-German team, respectively. In this paper the comparison of the magnetic survey and the excavation results will be presented.

Following the preliminary archaeological studies in the "64" settlement site, some features relating to the Achaemenid and Sassanid periods have been revealed, which show that this area was used for wine production in the Sassanid period. The magnetic survey was applied on 2 hectares and its magnetic gradient anomaly map can be seen in figure 1.

Anomalies relating to buried architectural features and also some other anomalies relating to archaeological objects appeared. The excavation continued, taking into account the results of magnetometry. In the gradient map arrows point the place of trenches. During the excavation, some parts of plans of architectural features appeared in places shown on the magnetic gradient map.

Excavation in the place of magnetic anomaly, which is indicated by number 1 on the map, revealed a structure that could have been used for wine production.

Figure 2 shows the results of excavation in the place of the magnetic anomaly, which is indicated on the map by number 1. In one of the other trenches, remaining parts of a pottery storage jar were discovered and its magnetic anomaly is indicated on the map by number 2. The other excavations, which are shown on the gradient map by arrows, are related to the remains of buried architectural features.

Figure 3 shows the magnetic gradient anomaly map relating to the Prehistoric period site named "131", the nearest site to the dam construction. Also, on this map the places with and without remains of settlements have been divided, which saved time for procedures of rescue archaeology by locating trenches precisely. The places of trenches are indicated on the gradient map by arrows. After excavation of these places, remains of kilns, ash layers, buried soil and pits were revealed.

This study can be a proof of the importance of applying geophysical methods in rescue archaeology.

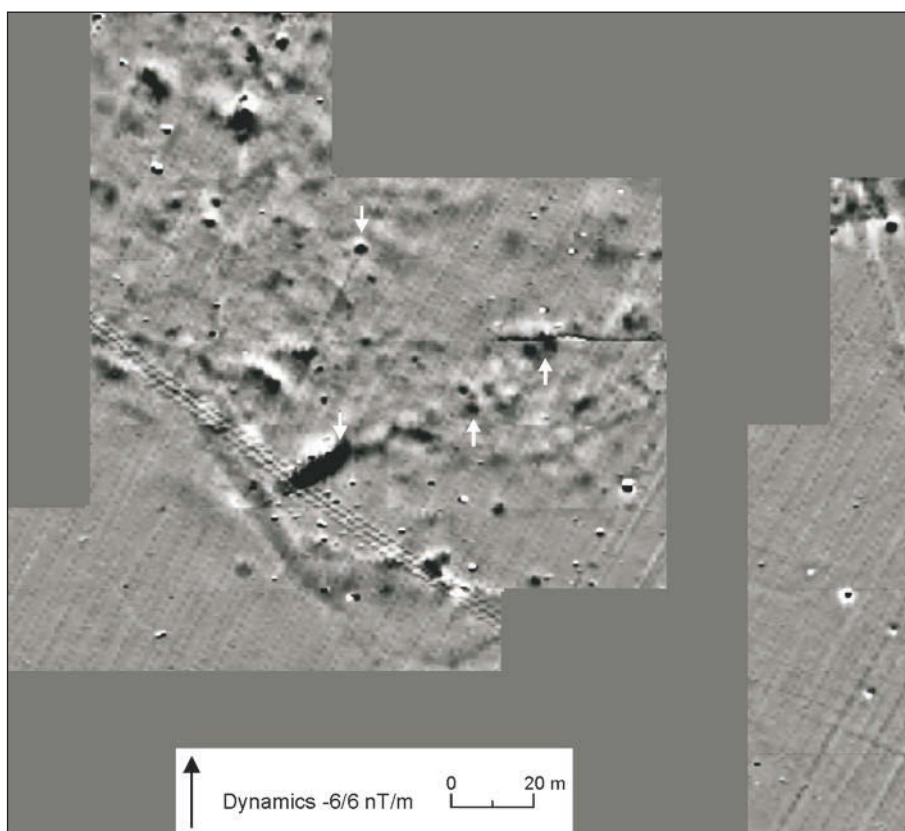

Fig. 3. Magnetic gradient anomaly map of site 131 in Tang-e Bolaghi.

REFERENCES

Abstracts

Scollar/Tabbagh/Hesse/Herzog
1990

Abstracts from Symposium on the Archaeological Rescue Excavation in the Bolaghi Valley, Shiraz, 2006.

I. Scollar/A. Tabbagh/A. Hesse/I. Herzog: *Archaeological Prospecting and Remote Sensing*, Cambridge, 1990.

Babak Aminpour

Parsa - Pasargadae Research Foundation
No. 5/5, Farihan Complex, Mofateh Str., Haft-e Tir Sq.
15849, Tehran, Iran
aminpour@kanoon.net

GPR INVESTIGATIONS IN THE ARCHAEOLOGICAL AREA OF FERENTO (VITERBO, LAZIO, ITALY)

Pier Matteo Barone - Elena Pettinelli - Elisabetta Mattei - Alberto De Santis - Elisabetta De Minicis

Key words: GPR, Ferento, buried structures

The ruins of Ferento (Viterbo, Italy) are found on a large plateau of 30 hectares, 8 kms from Viterbo (Fig. 1). The most important monument is the Roman theatre, which is still used for performances during the summer months. Ferento was primarily an Etruscan city, which later acquired more importance, in particular in imperial age. In the next period it was reduced to a village after the barbaric invasions, and destroyed by an incursion of the Viterbo people in 1172.

A 2nd century A.D. epigraph defines it as *splendidissima civitas*, and there was a rumour that it was the hometown of illustrious people like Flavia Domitilla, future wife of Titus and Otone.

The city was anciently crossed by a Roman road named *Ferentiensis*, which passed by the already mentioned theatre, the Forum, the *Augusteum* with 66 statues, the thermal baths and the porch built around a small lake.

Ferento had a remarkable development during the first imperial age, during which the total urbanization of the large plateau was completed. In the 5th century A.D., it was also a centre of a diocese, and was involved in the Byzantine-Longobard conflict. In that period, the city was totally fortified with a boundary wall and the theatre was readapted and used as a military defence structure.

Currently, the visible monumental remains have been brought back to the light by some diggings completed in 1910, and these ruins represent just a small part of the structures that are still buried.

There are two areas of geophysical interest, both located in the Eastern part of the Roman theatre and separated by a modern road.

In the Area 1 a GPR Noggin Plus Smart Cart system, equipped with a 250 MHz antennas was used. In this area two grids were acquired; the first one was collected using a distance of about 0.50 m between lines, a step size of 0.05 m, a time window of 80 ns and a trace stacking of 4. In all sections the structures were located between 16 ns and 24 ns. This first grid (15 mx14 m) is larger than the second one and it covers a part where the ancient walls are partially visible on the surface. It is interesting to note, that all the sections show many hyperbolas probably due to buried archaeological structures. Using the hyperbolas calibration technique, it was possible to calculate an average signal velocity of about 0.076 m/ns. Almost all hyperbolas seem to be continuous across the lines, as it was confirmed by the penetration maps, made using the average amplitude technique (Fig. 2). These maps show clearly buried orthogonal structures at a depth of approximately 20 ns (0.80 m ca); these kinds of structures are perhaps due to religious buildings and this seems to be confirmed by the second GPR grid.

The second grid in Area 1 (10 m x 7.1 m) is acquired using the same GPR system, the same antennas and the same parameters of the first one, but the distance between the lines was changed to 1 m in order to avoid the presence of a lamppost and uneven surfaces on the ground. This zone is remarkable for some surviving archaeological remains (in particular an apsis setting) that are particularly well visible in the GPR sections; in fact, the penetration maps show orthogonal anomalies at a depth of approximately 28 ns (1 m ca.) in agreement with what can be seen on the surface.

In the Area 2, on the other side of the modern road, some sparse archaeological remains are visible on the surface. Therefore, two GPR grids (6.50 m x 40 m) were collected in order to correlate such remains with the buried ones and to detect the Roman road (*Ferentiensis*) which, coming from the zone of the theatre, should cross this area.

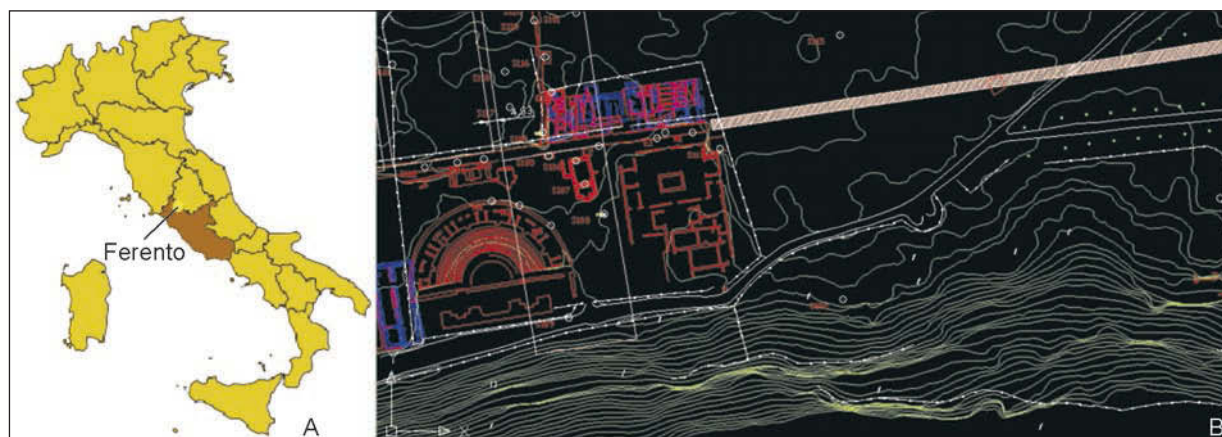

Fig. 1. A - shows the localization of Ferento in Italy; B - puts in evidence the two areas of the GPR investigations.

The GPR data were acquired using a GPR Noggin Plus Smart Cart system, equipped with both 250 and 500 MHz antennas; in the area, two parallel grids were collected using a distance of about 0.50 m between lines, a step mode of 0.05 m (for the 250 MHz antennas) and of 0.025 m (for the 500 MHz antennas), a time window of 60 ns and an a trace stacking of 4. The 250 MHz antennas data give better results than the 500 MHz ones; in fact the sections acquired

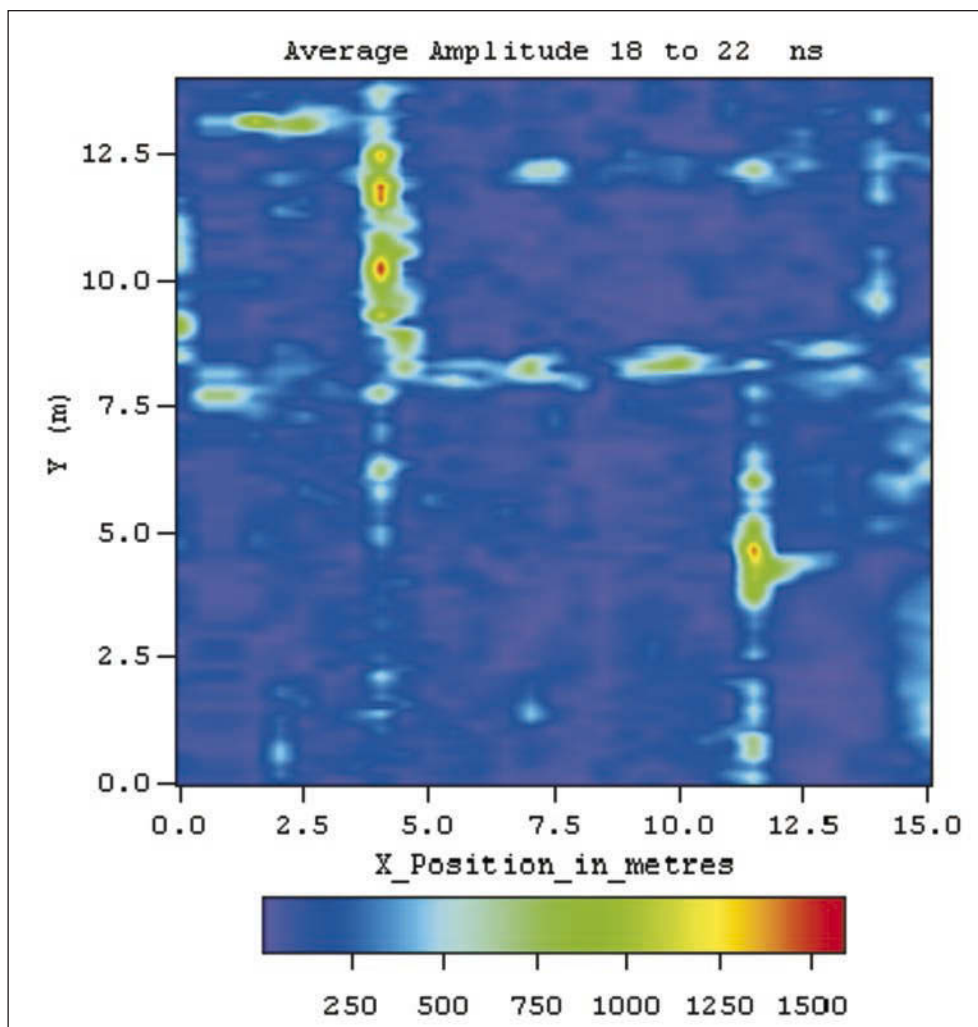

Fig. 2. Map collected in the area using the average amplitude technique algorithm. In evidence the orthogonal structures probably due to building walls.

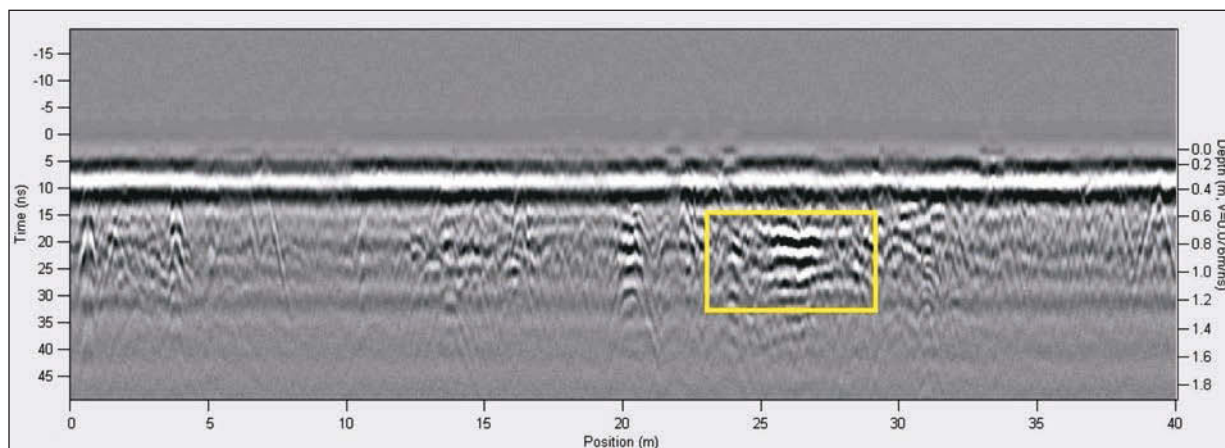

Fig. 3. Section that shows the presence of a sub-horizontal reflector probably due to a buried Roman road.

with the 250 MHz antennas show clearly, not only some continuous hyperbolas correlated to superficial ruins, but also a sub-horizontal reflector located at 26 m along the profile, and in a depth of 20 ns (0.80 m ca.), bounded by two hyperbolas (Fig. 3). Such an anomaly is probably due to the buried Roman road, which archaeologists have just partially dug in front of the theatre.

The results obtained with the GPR in the two investigated areas highlight the relevance of the technique in this specific site. In particular, this kind of archaeological prospection can be used to detect the geometry of the remains partially outcropping on the surface (the orthogonal structures, the sub-superficial prosecution of ruins and the identification of the *Ferentiensis* Roman road) and emphasize the potential of this site for further archaeological studies.

Pier Matteo Barone
Elena Pettinelli
Physics Department "E. Amaldi", University of Roma Tre
Via della Vasca Navale 84, 00146, Rome, Italy
pambarone@fis.uniroma3.it
pettinelli@fis.uniroma3.it

Elisabetta Mattei
Alberto De Santis
Elisabetta De Minicis
Università degli Studi della Tuscia
Via S. Maria in Gradi 4, 01100 Viterbo, Italy
mattei@unitus.it
desantis@unitus.it
e.deminicis@tiscalinet.it

FLUXGATE, OVERHOUSER AND CAESIUM-MAGNETOMETRY FOR ARCHAEOLOGICAL PROSPECTION AT ROSELLE-AIALI (ITALY)

Helmut Becker - Stefano Campana - Thomas Himmler - Iacopo Nicolosi

Key words: fluxgate, overhouser, caesium-magnetometry, duo-sensor configuration, gradiometer, total field measurement

The place name Aiali is sited on lowland between the medieval town of Grosseto and the Roman town of Roselle in central Italy. The site discussed in this paper was detected from the air during the Aerial Archaeology Research School organized by the University of Siena in 2001 (*Campana et al. 2006*). Aerial survey allowed us to recognize an area within which the growth of the wheat varied in such a way as to reveal an articulated group of traces that made up the plan of a complex of structures interpreted as a Roman villa, 4 hectares in extent. In the following years Aiali has become the most important test site for the Laboratory of Landscape Archaeology and Remote Sensing at Grosseto. Since 2001 we have collected, processed and interpreted many different kinds of data: Quickbird-2 satellite imagery, historical and recent vertical coverage (from 1954 to 2001), oblique air photographs in various years, seasons and lighting condition; field-walking survey, and in the course of the XV International Summer School in Archaeology at Grosseto several geophysical methods were tested for archaeological prospection at the Roman site at Roselle-Aiali for demonstration to the students. For the purpose of magnetic prospecting a highly automated system consisting of 4-Foerster-probes (Feret DLG) on a chart with GPS and an Overhauser magnetometer (GSM-19) were applied in the same grid. At the time of the summer school there was no caesium-magnetometer system available. Therefore the whole area had been re-measured some weeks later with a Scintrex Smartmag SM4G-special in various sensor configurations again in the same grid and under the same surface conditions for comparison (the magnetometer was made available for the test by Schweitzer-GPI company).

Most impressive to everybody was the performance of the Foerster-4-probe system with high resolution differential GPS on a chart. Hard- and software are very well developed and adjusted to the needs of archaeological prospection. But the limits of fluxgate-magnetometry are known and became also evident at the site. In general multi-probe fluxgate magnetometry is the ideal instrument for near surface structures with a high magnetization contrast. At Roselle-Aiali this was the case for the main building of the Roman villa. But the sensitivity of the Foerster probes and the vertical gradient configuration were not suitable for the detection of the deeper structures. However the vertical gradient configuration resulted in a perfect reduction of the very strong noise of the high voltage power line nearby (some squares were measured directly under the power line). The survey system consisted of 4 vertical gradient fluxgate probes with sensor spacing of 65 cm. The lower sensor was guided 25 cm above ground. The FEREX data logger offers a sampling rate of up to 100 Hz for each of the included 4 channels. In the present case 10 Hz had been selected. A measuring range of 10,000 nT is offered, with a sensitivity of 0.1 nT. One interface of the FEREX was used to connect a high resolution DGPS for positioning. The system offers a navigation aid by means a heading indicator on the built in screen that keeps the user on straight tracks during data sampling (Fig. 1).

A part of the Roselle-Aiali archaeological area has been surveyed with a GEM System GSM 19 Overhauser magnetometer equipped with an internal low cost GPS board, in order to evaluate the performance of the positioning system of this instrument compared to the more accurate acquisition by means of on ground grid definition.

The survey instrument, a single sensor scalar magnetometer, has been configured with a measurement sampling rate of 2 Hz maintaining a distance sensor-ground of about 20 cm; this magnetometer has a sensitivity of 0.01 nT with a maximum measurable spatial gradient of 10,000 nT/m. During the survey the magnetometer internal clock is synchronized with the GPS signal in order to precisely attribute a spatial datum to the magnetic field values. The internal GPS board is a 12 channel EGNOS enabled system with a resolution of less than 1.5 meters (<http://www.gemsys.ca/>). During the acquisition the GPS coverage has been quite good with not less than 8 satellites and EGNOS correction signal available.

To monitor the magnetic field temporal variations, a second magnetometer has been used in a fixed station nearby the survey area (base station); a GEM System GSM 19 T proton precession magnetometer with a sampling rate of 1 Hz with an internal GPS board to synchronize the two magnetometers clocks has been used, assuming that the temporal variations of the base station and of the survey area were the same. After fixing a reference time, the temporal variations measured by the base station unit has been removed from the data acquired by the survey unit, so that the residual magnetic field represents the spatial variations component only.

The global surveyed area is represented in Fig. 2 with two colored lines groups indicating two different acquisitions days; the "blue lines" group (area1) surveyed area, with main lines direction of N10°, is 2 hectares wide, the "red lines" one (area2), with mean direction N38°, is 0.4 hectares wide. The first group has been acquired in 4 hours of continuous measurement, the second in 2 hours. The total survey lines length is about 22 km with 43000 measures; the mean line spacing for the first group is 1.25 meters with a spatial density of 1.4 measures/m², for the second group the mean line spacing is 1.1 meters for station density of 3 measures/m².

In order to map the magnetic anomaly values, a regular data distribution (mesh) of magnetic stations has been realized applying a gridding algorithm to the real measurements; the grid spacing for both areas is 0.5 meters interpolated.

In Fig. 2 it is reported the resulting magnetic anomaly map displaying the data mesh by means of a grey graded scale. The chosen grey scale linear dynamic range is +/- 15 nT that represents the best interval to visualize the measured magnetic anomalies.

The Overhauser magnetometer seemed to be not very suitable for archaeological prospection independent of the sensor configuration (vertical gradient measurements, variometer = correction by a base station and non-compensated duo-sensor configuration were tried). Measuring speed, inadequate sensitivity and heavy weight of the sensors are the main disadvantages for archaeological prospection.

The caesium-magnetometry with Smartmag SM 4G-special was applied for the whole field in the duo-sensor configuration on a chart with half automated positioning by the rotation of the wheel for non compensated total field measurements. Spacing of the lines was set to 0.5 m and sampling rate to 0.1 Hz (10 measurements per second, corresponding to 10 - 15 cm sample spacing). Later in data processing and visualization of the magnetograms the raster

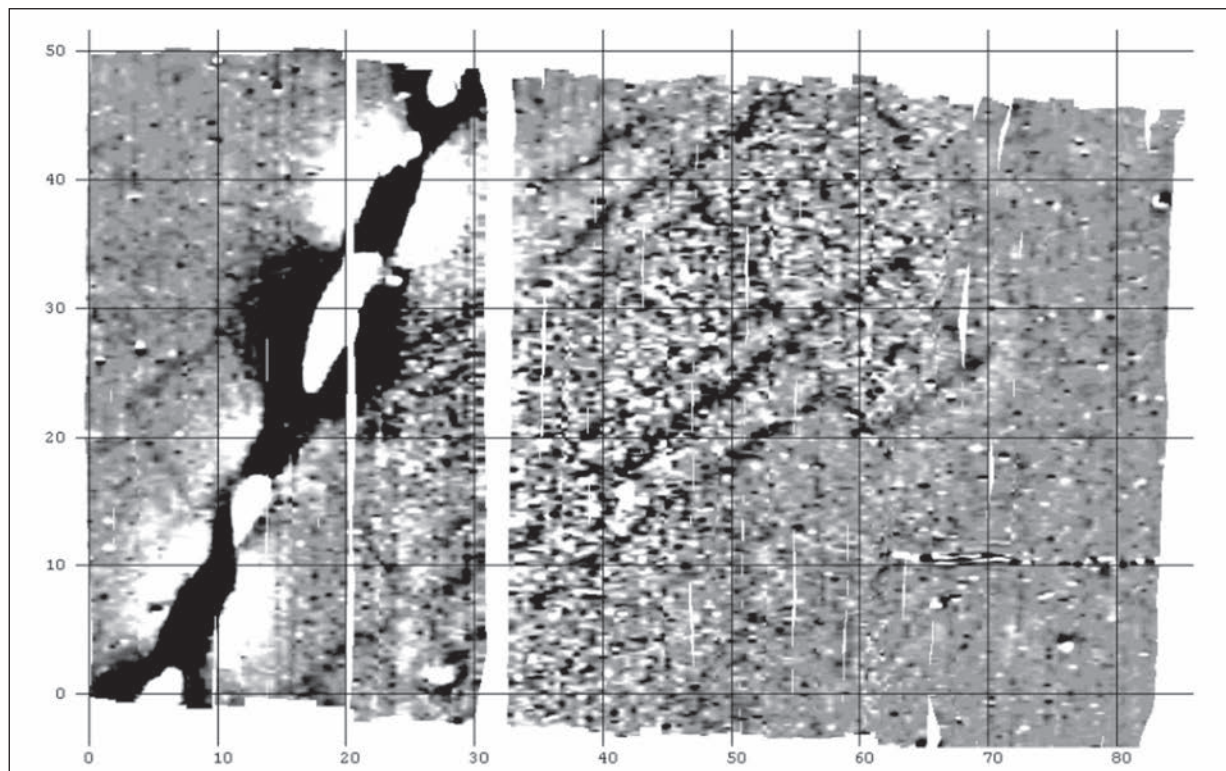

Fig. 1. Magnetic map of the data collected on the main building of the roman villa using the Foerster-4-probe system.

was interpolated to 0.25x0.25 cm. For the reduction of the high frequency noise a bandpass filter in the magnetometer processor was set to 5 Hz.

Re-sampling and the reduction of the diurnal geomagnetic variations by line-mean and square mean value were processed by RESAM2. Further data processing and visualization of the magnetograms were achieved by Geoplot 3, Archaeo-Surveyor, Surfer 8 and Photoshop. In the raw data the long wave length noise of the high voltage power line is strongly visible. But this could be cancelled by desloping filters in Archaeo-Surveyor. Unfortunately the main building of the Roman villa had been cut by a modern pipe line with steel flanges, which gave very strong magnetic disturbances, which could only partly removed by filtering techniques (Fig. 3).

Part of the main building had been re-measured by Smartmag caesium-magnetometer with different methods for comparison. Fig. 3a, b, c shows the measurement on the chart with long wave length reduction by line mean (a), square mean (b) and complete reduction by deslope filtering on the line (c). Fig. 3d gives the example of the measurement with a hand carried frame with the distance triggering on the line only every 5 m by switching. The high fre-

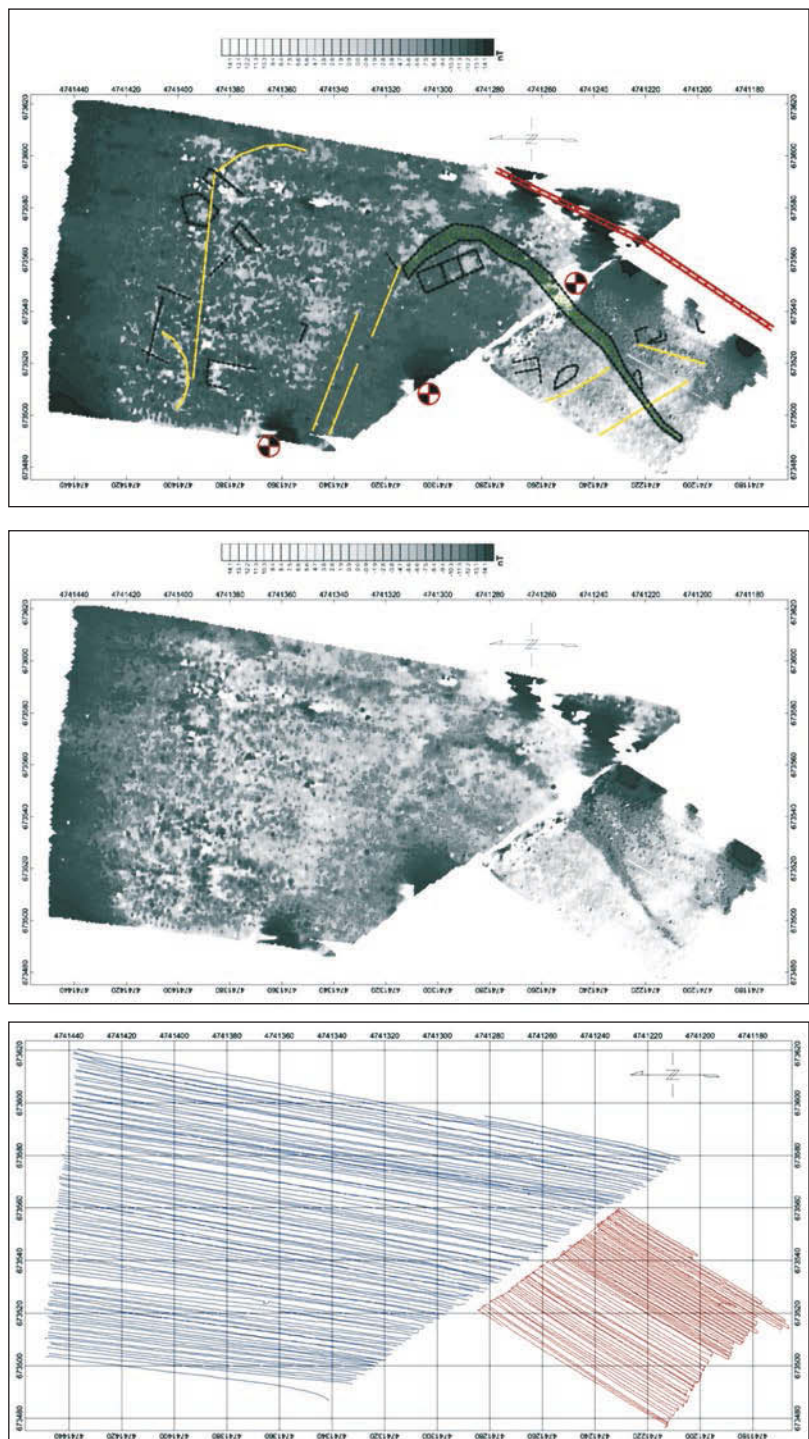







Fig. 2. From the left side: surveyed profile lines at Roselle-Aiali archaeological area (UTM 32N, WGS 84); magnetic anomaly map of Roselle-Aiali archaeological area; interpretation of magnetic data.

-  power line tower;
-  pipe;
-  possible subsurface archaeological structures;
-  linear anomalies;
-  negative magnetization contrast area (paleochannel? Road?).

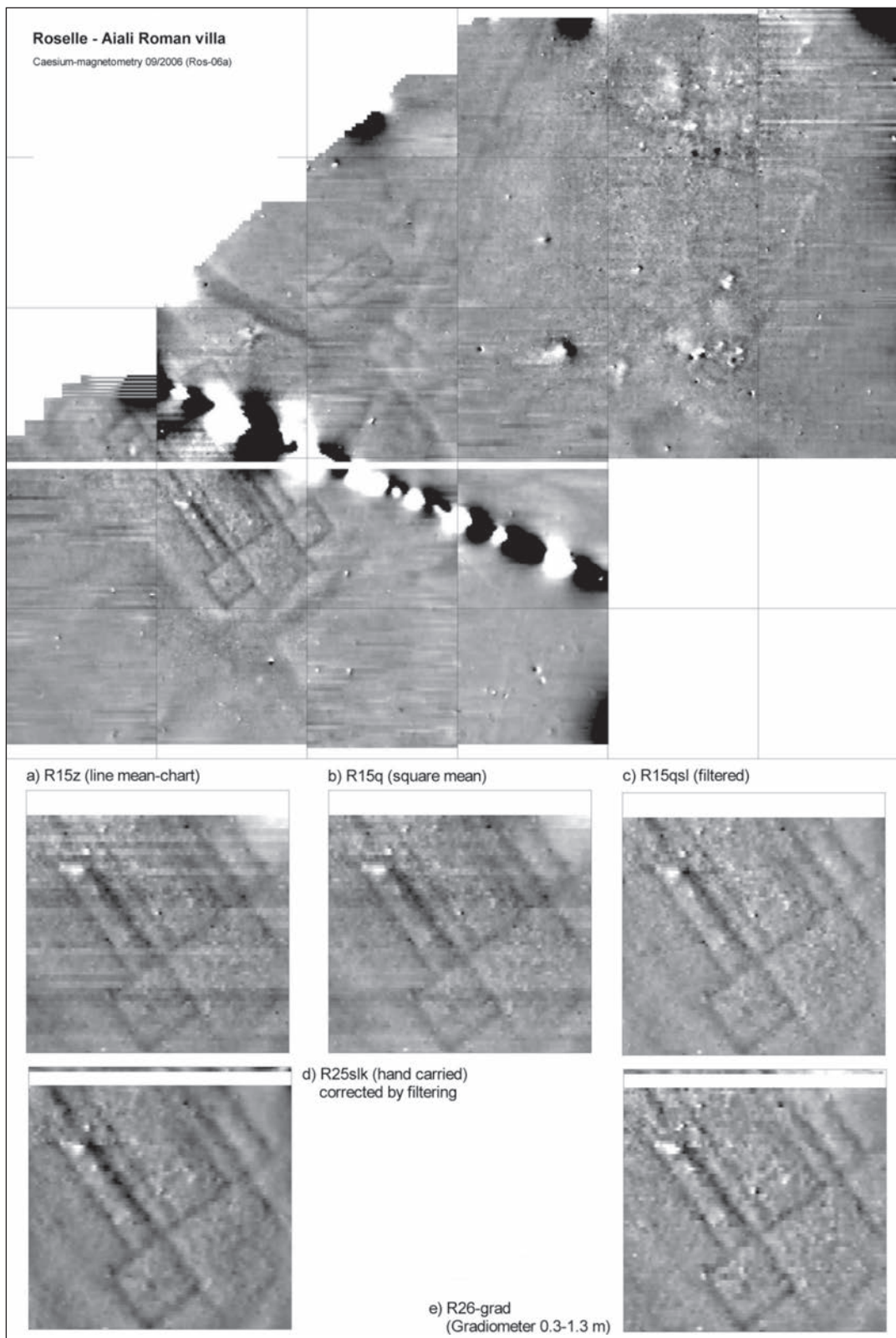

Fig. 3: Roselle-Aiali. Caesium-magnetometry with Scintrex Smartmag SM4G-special with duo-sensor configuration on a chart. Sensitivity 30 pT at 10 Hz cycle. Raster 0.10x0.5 m (interpol. 0.25x0.25 m), dynamics ± 25 nT, 40m-grid. Roselle-Aiali. Caesium-magnetometry of a part of the main building with various sensor configurations. (a) Measurement on a chart, reduction of the time dependent anomalies by the reduction on the line mean value, (b) same by square mean value, (c) reduction of the long wavelength anomalies on the square mean value, (d) measurement with the hand carried frame and (e) gradiometer measurement with 0.3 m and 1.3 m above ground.

quency noise is minor, which is due to a more quite movement of the sensor compared with the rather bouncy push-pulling method of the chart over a field with lots of stones at the surface. Fig. 3e shows the result of a hand carried vertical gradient measurement over 1 m with the lower sensor at 0.3 m and the upper sensor at 1.3 m above ground. Despite of the optimal reduction of the long wave length anomalies of the power line we loose by the gradiometer setup of the sensors the information of the deep structures under the surface and in speed the factor of 2. Considering the essential importance of the 3 "S" in archaeological prospection - Speed, Spacial resolution and Sensitivity - one should forget gradiometer- or variometer measurements and not waste the second sensor for minor quality of the magnetogram of an archaeological site.

REFERENCES

- Becker 1995* H. Becker: From Nanotesla to Picotesla - a new window for magnetic prospecting in archaeology. *Archaeological Prospection*, 2, 1995, 217-228.
- Becker 1999* H. Becker: Duo and quadro-sensor configuration for high speed/high resolution magnetic prospecting with caesium magnetometer. *Archaeological Prospection*. Proceedings of the 3rd International Conference on Archaeological Prospection. Fassbinder JWE, Irlinger E (eds). Munich 1999, 100-105.
- Campana/Piro/Felici/Ghisleni 2006* S. Campana/S. Piro/C. Felici/M. Ghisleni: *From Space to Place: the Aiali project (Tuscany-Italy)*, in Campana S., Forte M. (eds.), *From Space To Place*. 2006.
- Tabbagh 2003* J. Tabbagh: Total Field Magnetic Prospection: Are Vertical Gradiometer Measurements Preferable to Single Sensor Survey? *Archaeological Prospection* 11, 2003, 75-82.

Helmut Becker
Becker Archaeological Prospection
Loisachweg 32
D-82547 Beuerberg, Germany
becker.mag@googlemail.com

Thomas Himmler
Foerster Group, Institut Dr. Foerster GmbH & Co.
KG Sitz Reutlingen,
Amtsgericht Stuttgart HRA 350774, Germany
himmler.thomas@foerstergroup.de

Stefano Campana
Department of Archaeology and History of Arts
Section of Medieval Archaeology, University of Siena
Via Roma 56
53100 Siena, Italy
campana@unisi.it

Iacopo Nicolosi
Italian Institute of Geophysics and Vulcanology
Viadi Vigna Murata 605
00143 Rome, Italy
nicolosi@ingv.it

USAGE OF "CORONA" SATELLITE IMAGES IN THE CREATION OF A GEO INFORMATION SYSTEM (GIS) "ARCHAEOLOGICAL SITES OF THE STAVROPOL REGION"

Andrey Belinskiy

Key words: GIS, CORONA KH-4B, Stavropol Region, Russia

SUO "Nasledie" (affiliated to the ministry of culture of the Stavropol region) is involved in creating a Geo Information System that incorporates archaeological sites of the region. Stavropol region is situated in the central part of the Northern Caucasus, between Caspian and Black seas. It occupies the area of 66300 km sq. The GIS is created on the basis of Arc View software suite. Data processing is done via ER Mapper suite with occasional usage of Erdas Imagine system. At the moment GIS contains raster layers of topographic maps to the scale 1:25000 and 1:100000, vector layers of topographic materials and remote sensing data of administrative borders of the region, human settlements, hydrographical objects, infrastructural objects (roads, power lines, and gas and oil pipelines), relief, archaeological sites, etc. Currently, total amount of archaeological sites in the database is more than 30000. Besides cartographical materials geometrically transformed, coloured multizonal satellite images are used. The images are made with a camera KFA-1000 and cover the area of 56000 km². Spatial resolution of these images is around 4-5 meters and 8 micron. For some locations, the database contains aero photo images of various scales of the total area of 12000 km sq. At the moment around 3000 km sq of those images are geo coded. Due to the employment of the "elastic sheet" algorithm during geo coding, it is not possible to obtain a degree of connectedness of air and satellite images of more than 2-3 pixels. Precision of geo coding, after being verified on the spot, constitutes 3-5 meters, which is enough

to produce maps to the scale of 1:25000. Since 2006, "CORONA KH-4B" satellite images have been used in the GIS. 54 scenes are currently being analysed of the total area of 140 097 km sq, 20 000 km sq of which have been geo coded.

The CIA programme "CORONA" had been developed as a secondary system of the ARS (Advanced Reconnaissance System), US Air Force, then SENTRY, then SAMOS. Unlike SAMOS the key concept of "CORONA" programme was the delivery of the film back to the Earth. After a year of testing and 14 failed launches, on 18th August 1960 first images of a resolution of 8-12 meters were made by the KH-1 (Key Hole) camera. Until the end of the programme in 1978, photo equipment was constantly improving, which allowed obtaining images of a resolution of 10-15 cm. In total 145 missions were carried out and 800,000 scenes of the territory of the USSR and other regions of the world were shot. Due to the fact that in 1995 all the images were declassified, it became possible to use them for scientific purposes. With the appearance of new digital products scanned at 3600 dpi (7 micron) from US Geological Survey the image quality increased dramatically.

Our main task was the creation of a uniform layer of spatial-visual information of the region during the period of the late 60s and early 70s, on the basis of these data.



Fig. 1. Kurgan graveyard of the Early Scythian time with typical trenches around the mound.

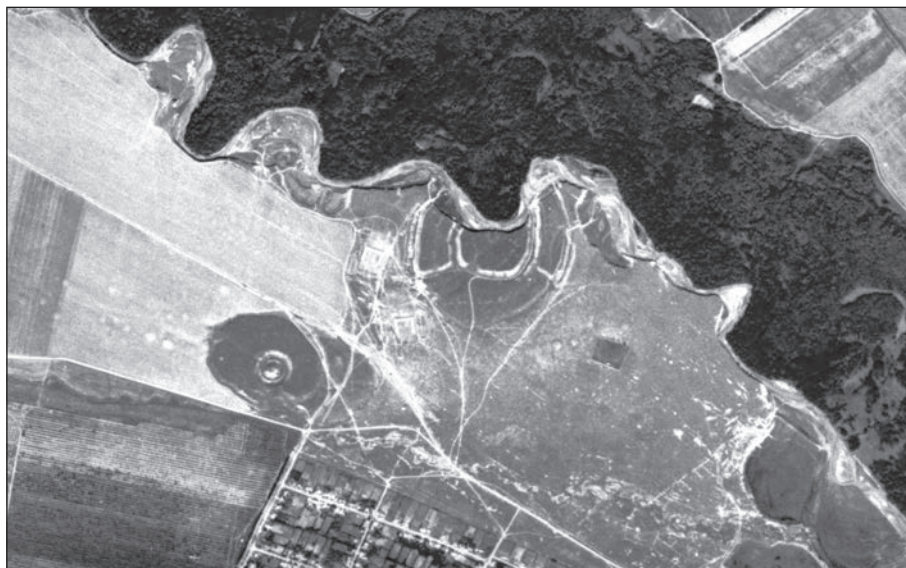

Fig. 2. Early Alanian settlement and the surrounding kurgan graveyard.

The potential of contemporary means of digital recording of primary data, as well as the high level of spatial resolution allowed not only to create one of the layers of GIS, but also to perform certain specialised tasks in identifying various types of archaeological sites (kurgans and settlements). In some cases it led to the revelation of cultural and chronological characteristics of monuments. The analysis of the images helped discover, in the South of the region, kurgan graveyards of early Scythian culture, which have peculiarities in the construction of kurgans and near kurgan space. Excavation on the site of one of these objects confirmed the initial attribution of the monument. In a similar manner numerous settlements and graveyards of early Alanian culture were discovered in unexplored areas. It is important to mention that attempts to discover those sites using conventional methods of field reconnaissance did not bring any fruitful results for decades and in most cases their discovery was accidental.

It is interesting to note that in some locations certain objects are clearer in "CORONA KH-4B" images than in aero photos of medium to large scale, or present generation satellite images of high resolution. It might have connection with the "generalisation" effect and higher contrast of black and white imagery. Ability to encompass large territory of fast scaling proves to be very convenient when dealing with these images.

In general, it seems that it is first now that the product of the Cold War produces some useful results. This enormous source of data allows us to undertake general tasks of preservation of historic and cultural heritage as well as to deal with more specific issues of identifying particular types of archaeological sites.

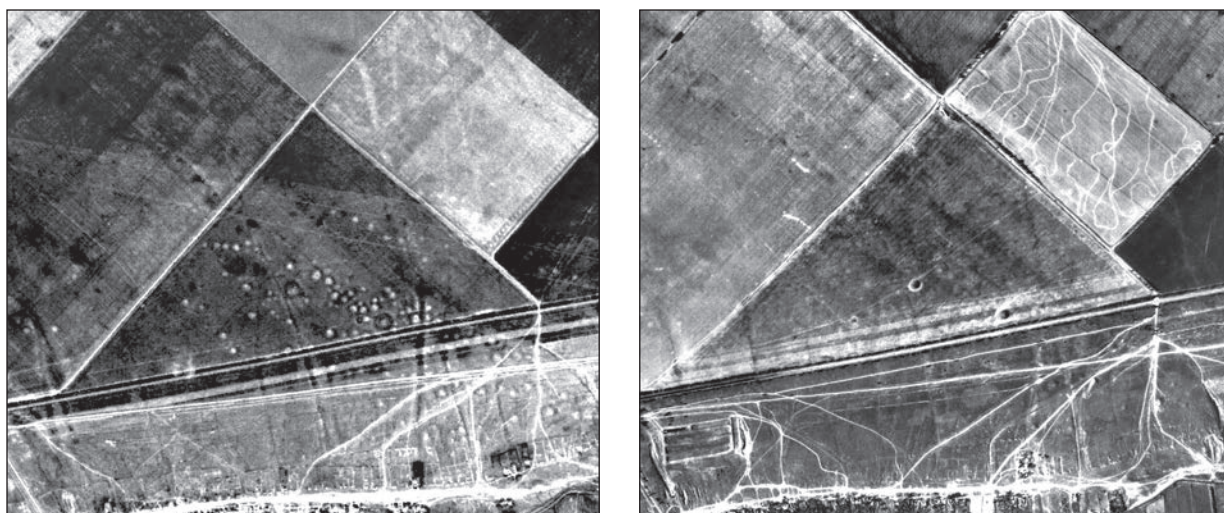

Fig. 3. Photograph of a fragment of the kurgan graveyard made by CORONA KH-4B, May 1972 (left). Same fragment Aero photo 06 Sept 2001 m 1 : 43 000 (right).

Andrey Belinskiy
SUO "Nasledie"
pr. Karl Marks 56, Stavropol, 355006, Russia
nasledie@nasledie.org

STUDY OF ANCIENT CITY PLANNING WITH AXIAL MAPS AND VISIBILITY GRAPH ANALYSIS

Christophe Benech

Key words: magnetic survey, city planning, space syntax, axial map, hippodamian plan

Concerning the study of ancient city planning, the geophysical surveys provide an original and important contribution to the archaeological documentation. In many cases, the geophysical map offers a new vision of the spatial organization of the archaeological site, more homogeneous and more continuous than with excavations. The traditional approach of the study of urbanism is necessarily going to change but first of all, we must define a methodological approach in agreement with the "nature" of geophysical data.

Most of the time, the street network is poorly known by archaeological excavations, whose aim is to deduce the theoretical plan of city planning and to have a stratigraphic sequence of the street. On the geophysical maps, it is often possible to follow the layout of the streets on their whole length: the result is a more dynamic – and more complex – street network far from the theoretical plan deduced from the excavations. With such a detailed image, we can envisage a morphologic study, as usually performed on modern city planning.

The method we propose to use here is the *Space Syntax*, developed by B. Hillier and J. Hanson from the Bartlett School of London. The *Space Syntax* is a topological method which permits the representation, quantification and interpretation of spatial configurations in buildings and settlements. For the study of the street network, we will use “axial maps” which allow us to analyse:

- circulation inside the city
- evolution of the parcel of the city planning
- control points inside the city
- integration or segregation of different quarters of the city
- relation of the street network to the administrative, religious and military installations of the city

A complementary approach of the axial is the use of visibility graph analysis, particularly interesting in the case of orthogonal city planning like the Hippodamian plan. This analysis is based on the concept of isovist, which is an area in a spatial environment directly visible from a location within the space. The visibility graph analysis gives a good indication of how people might interact with space and move through it. We get thus a more detailed vision of the irregularities of the Hippodamian and of the facilities of circulation, by taking into account the width of the street along its continuity and its connections with the street network.

The study of the city planning morphology will be presented here on the site of Doura-Europos (Syria). The city planning of this Hellenistic site, located on the right bank of the Euphrates, is inspired from the Hippodamian plan based on rectangular blocks separated by an orthogonal street network. In this case, we observe the result of a centuries long occupation, based on the use of the Hippodamian plan. Even if the main characteristics of the city look have been preserved, the evolution of the city modified the egalitarian concept of this type of plan, and we observe a hierarchical organization through the streets and the blocks. In this communication, we will show how the use of the axial maps with geophysical maps highlights the economic, social and military connections of the city but also the organization and the evolution of the population inside this urban space.

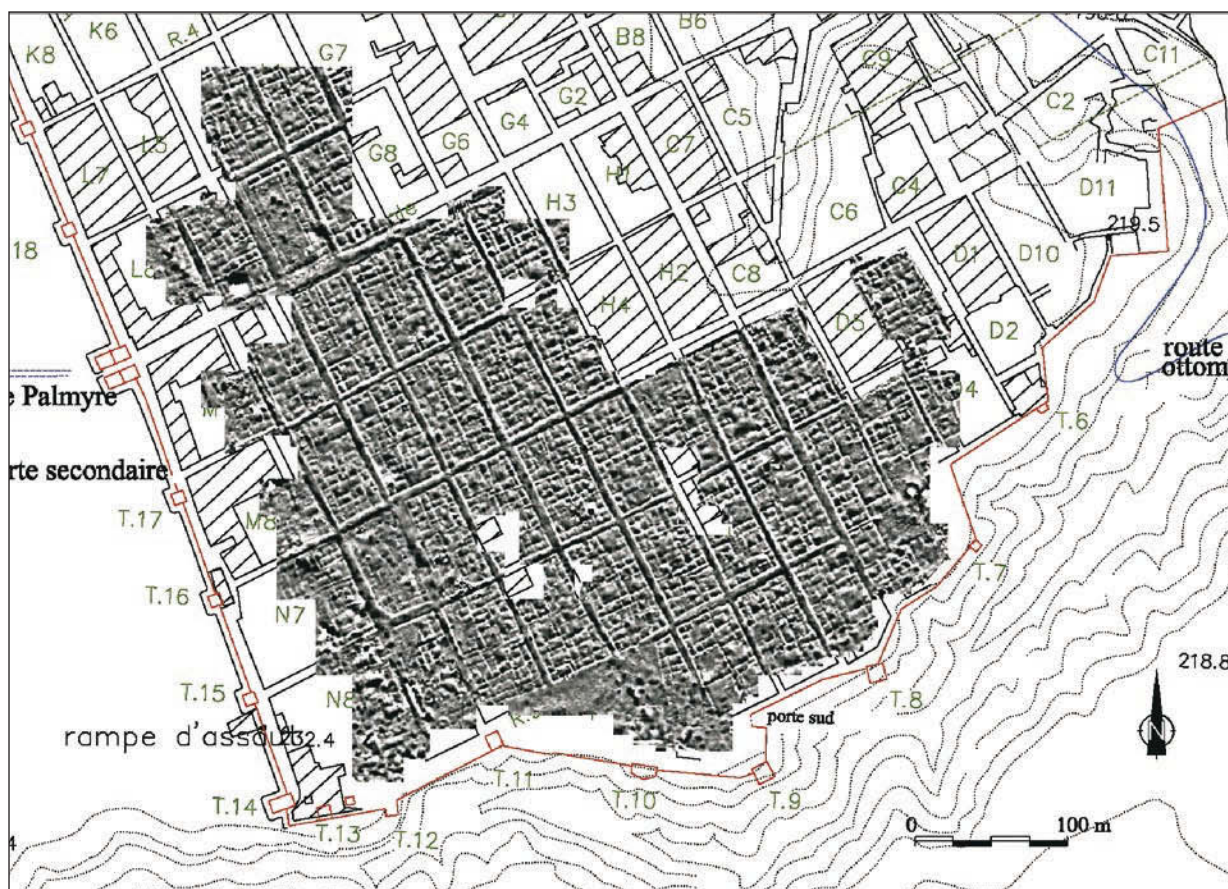

Fig. 1. Magnetic survey of the southern part of the Hellenistic city of Doura-Europos (Syria). Magnetic scale: -10 / +10 nT/m.

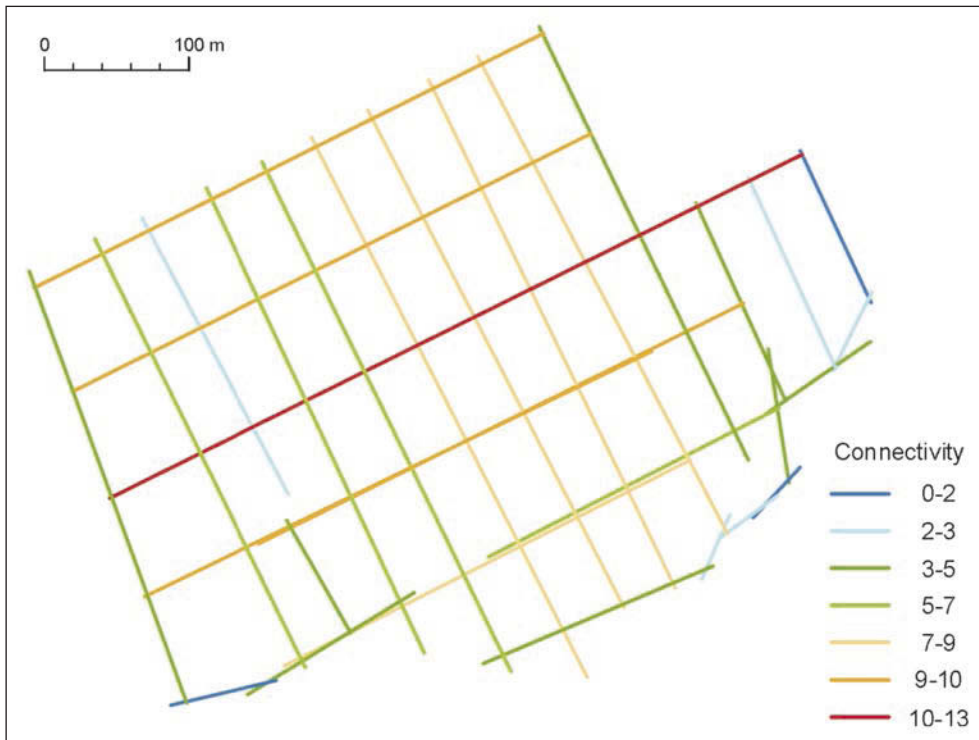

Fig. 2. Axial map of the street network from magnetic survey. The connectivity depends on the number of connections of one street with others.



Fig. 3. Visibility graph analysis of the street network: the irregularities of the Hippodamian are highlighted. The visualization of the "integration" parameter (minimum blue/maximum red) shows a slightly different hierarchical organization of the streets than with the axial map.

REFERENCES

- Benech in print* C. Benech: New approach to the study of city planning and domestic dwellings in the ancient Near East. *Archaeological Prospection*, in print.
- Hillier/Hanson 1984* B. Hillier/J. Hanson: *The social logic of space*, Cambridge University Press: Cambridge.
- Turner/Doxa/O'Sullivan/Penn 2001* A. Turner/M. Doxa/D. O'Sullivan/A. Penn: From isovists to visibility graphs: a methodology for the analysis of architectural space. *Environment and Planning B: Planning & Design*, 28, 2001, 103-121.

Christophe Benech

Maison de l'Orient et de la Méditerranée - UMR 5133 Archéorient 7
Rue Raulin F-69365, Lyon Cedex 7, France
christophe.benech@mom.fr

ELECTRICAL RESISTIVITY INVERSION MODELLING STUDIES FOR COMMONLY USED ARRAYS IN HÖYÜK (ARTIFICIAL HILL) TYPE OF ARCHAEOLOGICAL SETTLEMENTS

Meriç A. Berge - Mahmut G. Drahor

Key words: resistivity modelling, inversion, höyük

In archaeological prospection studies, the conventional resistivity survey technique, which provides a map of apparent resistivity data for single or several levels of electrode separations, has been widely applied since the 1960s. In this technique, the map is generally produced using the apparent resistivity data which is not only a function of the subsurface resistivity distribution but of the geometry of electrodes as well. Recently, the applications of tomographic resistivity method have quickly increased in archaeological investigations, and the data collection procedures have also advanced. In application, tomographic resistivity data are collected along a measuring line by sequence of a selected configuration for building up a pseudo-section (2D) or obtained over a selected area by different arrangements of electrode configurations for true 3D surveys (*Drahor et al., in print*).

The aim of this study was to investigate the performance in determining of buried archaeological structures settled one after the other using 2D and 3D electrical tomographic methods. Thus we firstly performed 2D and 3D synthetic resistivity modelling studies considering a höyük (artificial hill) settlement type, which could be widely seen on the Anatolian and Mesopotamian landscape. The höyük settlements are formed from complex archaeological contexts which contain the buried structures from different archaeological periods. In the artificial hill sites, mud brick is generally an important building material. Also stone building foundation, walls of various materials, ovens and workshops are found in these sites. The mud brick quickly erodes by natural reasons and over time, and it turns into small hills that cover the settlement (*Drahor and Kaya, 2000*).

The forward and inverse resistivity modelling studies are an important approach to simulate the synthetic models like buried objects. Cases similar to the real position of subterranean structures could thus easily be investigated by synthetic modelling studies before the archaeological application (*Papadopoulos et al. 2006*). In this study, we used a synthetic archaeological model that simulates the höyük type of archaeological context. There are three different archaeological structures settled one after the other in this model. The modelling area is in 40x40 m dimensions. The top surface of upper structure is buried in 0.25 m depth, and its width and thickness are about 0.5 m and 0.75 m. Its resistivity value is designated as 500 Ωm . The top surface of the middle structure is almost settled under the first structure. The width and thickness are also similar to the first structure, but the resistivity value is selected as lower (20 Ωm) to simulate the mud brick structures. The bottom structure is settled between 1.75 and 3.75 m. The width and thickness are in 1 m and 2 m respectively, and the resistivity value of this structure is 1000 Ωm . However, the background resistivity was set equal to 100 Ωm (Fig. 1).

In the first stage of modelling studies, the synthetic data was created, assuming that 2D lines parallel the X- and Y- axes. The line and electrode intervals were set up as 0.5, 1 and 2 m in order to test the effects of these intervals on the determination of archaeological structures. To obtain the synthetic apparent resistivities, the models created for different structures were modelled with finite-difference algorithm using RES2DMOD and RES3DMOD software for five various configuration types (Wenner-alpha, Wenner-Schlumberger, dipole-dipole, pole-pole and pole-dipole). In addition, the synthetic data was distorted using Gaussian noise (3, 7 and 10%) in order to test the successive determi-

nation in the presence of noisy conditions. The resistivity inversion studies were carried out in two different phases (for 2D and 3D investigations). We firstly performed the 2D resistivity tomography using robust (L_1 norm) algorithm (Loke 2001). All apparent resistivity data obtained from synthetic lines was inverted by RES2DINV in X and Y directions, respectively. Then, the inverted 2D data was combined in order to obtain a quasi-3D resistivity distribution in the model for the X-axis, Y-axis and XY-axis. Afterwards, the 3D data was obtained by combination of all data sets related with the X-axis, Y-axis and XY-axis to perform the 3D inversion. This procedure was completely performed by 3D robust inversion routine using RES3DINV software according to categories presented by Loke (2001). Then, all 2D and 3D inverted data were represented as 3D slices to compare the real resistivity values to each other. To obtain more visible images, the model limits of investigated area were taken as 20x20 m in the figures.

In Fig. 2A, 3D resistivity inversion slices, resulted from all three data sets (X, Y and XY directions), are given for dipole-dipole configuration. 2D resistivity inversion slices obtained from same directions are also presented in Fig. 2B. We obtained these results after six iterations, and the ABS errors were less than 0.6%. As can be seen from these figures, 3D resistivity inversion results are more successful than 2D results for this depth, and the results obtained from XY direction in 3D slices are better described in the original synthetic structure. A comparison of 3D results obtained from XY direction for five different arrays is presented in Fig. 3. These inverted resistivity slices were obtained from depth of 0.75, 1.25 and 1.75 m. The shallow resistive structure in the model was clearly determined in all results obtained from five different arrays for 0.75 m depth. The conductive structure is also determined in other depth levels except for pole-pole array. The second resistive structure settled in a deeper part of the model is observed in almost all array results. However, the result obtained from dipole-dipole array is more definitive to describe the third buried model structure (Fig. 3). As a result, we determine that all arrays were generally given informative results in the determining of höyük type of synthetic model structures.

The testing of these results for a real archaeological case has been done in Bayrakli archaeological site near to the city of Izmir, Turkey. This archaeological site is an important höyük settlement type in Western Anatolia. The archaeological context of this settlement is similar to the synthetic model, and the top layer of settlement is very close to the surface. We conclude that the first results obtained from this site are also convenient to synthetic modelling results.



Fig. 1. A - Plan and B - three-dimensional view of the synthetic model.

REFERENCES

*Drahor/Kurtulmus/Berge/
 Hartmann/Speidel in print*

M. G. Drahor/T. Ö. Kurtulmus/M. A. Berge/M. Hartmann/M. A. Speidel: Magnetic imaging and electrical resistivity tomography studies in a Roman military installation found in Satala archaeological site from northeastern of Anatolia, Turkey. *Journal of Archaeological Science* in print.

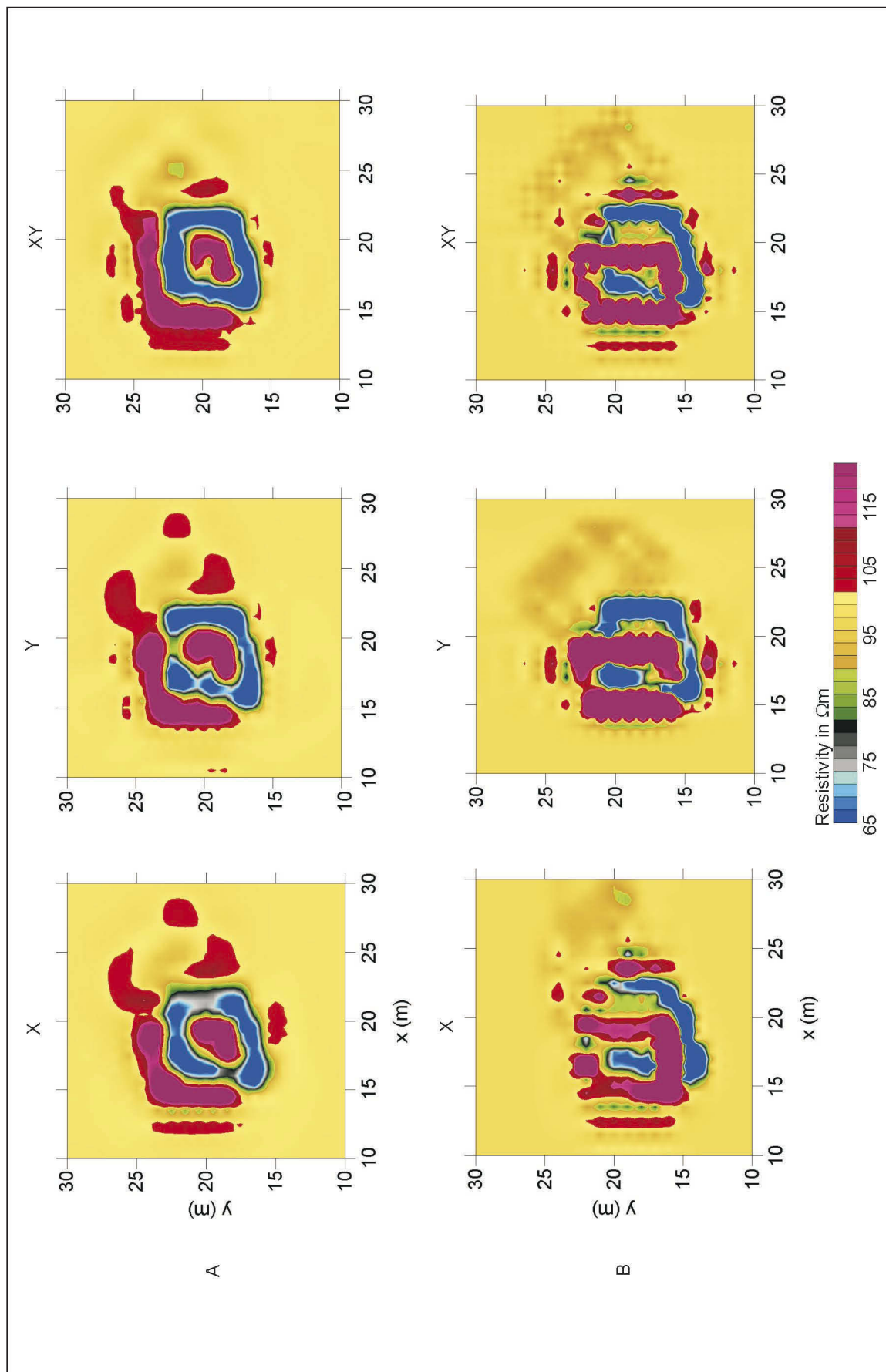

Fig. 2. A - 2D and B - 3D resistivity inversion results in x-, y- and xy-directions for dipole-dipole array in the depth slice of 1.25 m.

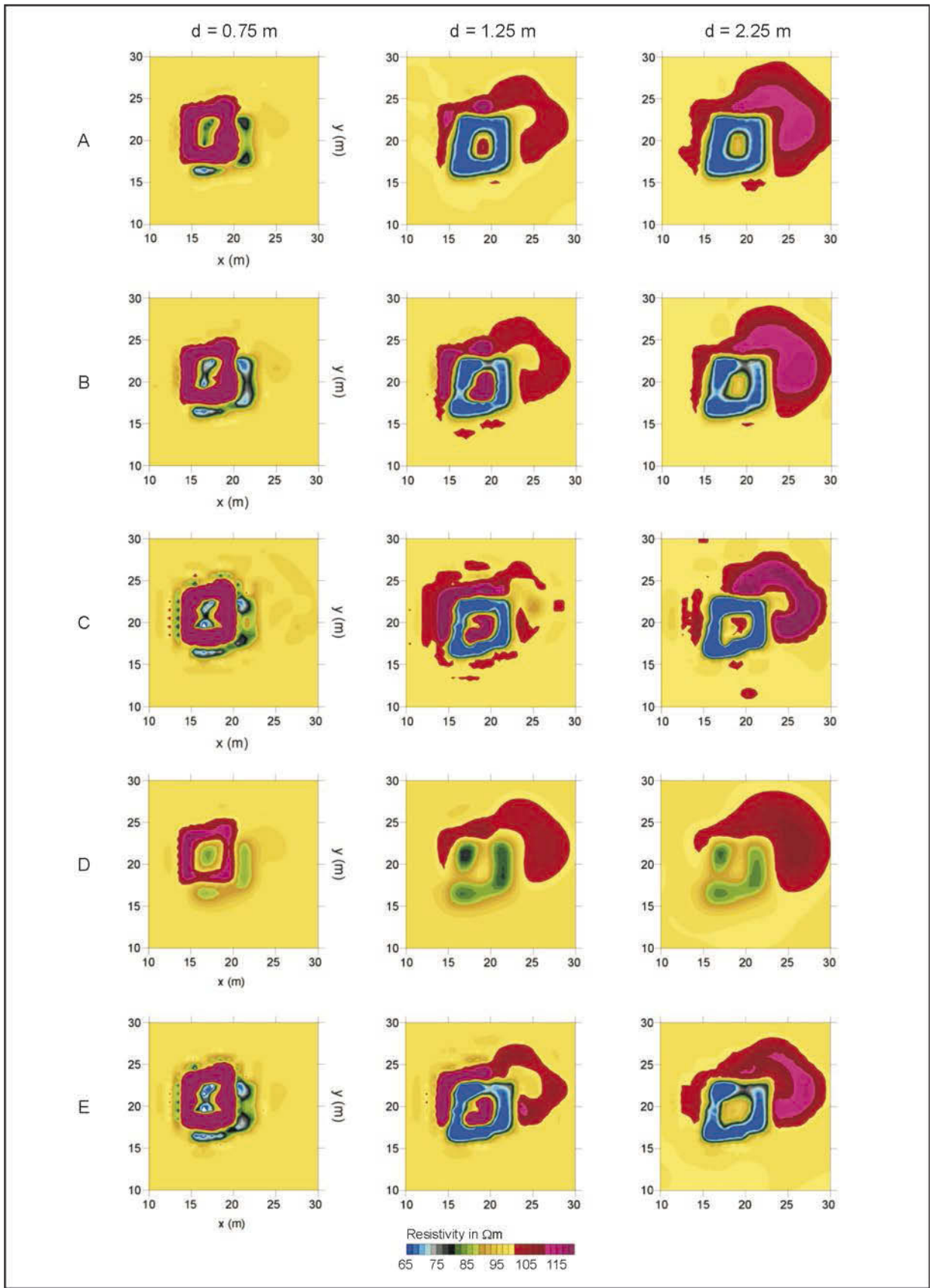

Fig. 3. 3D resistivity inversion results in xy-directions for A - Wenner-alpha, B - Wenner-Schlumberger, C - dipole-dipole, D - pole-pole and E - pole-dipole arrays in the depth slice of 0.75, 1.25 and 1.75 m.

- Drahor/Kaya 2000* M. G. Drahor/ M. A. Kaya: A large-scale geophysical prospection in the Acemhöyük the site of the Assyrian trade colony period. Turkish Academy of Sciences Journal of Archaeology 3, 2000, 85-107.
- Geotomo software 2002* Geotomo software: RES2DMOD, RES3DMOD, RES2DINV, RES3DINV, www.geoelectrical.com.
- Loke 2001* M. H. Loke: Tutorial: 2-D and 3-D electrical imaging surveys. Penang, Malaysia, Universiti Sains Malaysia, Unpublished course notes, www.geoelectrical.com.
- Papadopoulos/Tsourlos/Tsokas/Sarris 2006* N. G. Papadopoulos/P. Tsourlos/G. N. Tsokas/A. Sarris: Two-dimensional and three-dimensional resistivity imaging in archaeological investigations. Archaeological Prospection 13, 2006, 163-181.

Meriç A. Berge
Mahmut G. Drahor

Center For Near Surface Geophysics and Archaeological Prospection (CNSGAP)
Dokuz Eylül University, Engineering Faculty, Department of Geophysics
Kaynaklar Campus, 35160 Buca-İzmir, Turkey
meric.berge@deu.edu.tr
goktug.drahor@deu.edu.tr

MULTIMETHODOLOGICAL APPROACH TO THE STUDY OF ANCIENT CITY PLANNING: THE CASE OF PTOLEMAIS IN CYRENAICA, LIBYA

Miron Bogacki - Wiesław Małkowski - Tomasz Mikocki - Krzysztof Misiewicz - Monika Muszyńska

Key words: archaeological survey, remote sensing, aerial photokite photography, resistivity pseudotomography

The site of ancient Ptolemais (the modern village of Tolmeitha in Libya - GPS 32°42'25,8N"20°57'9,4E) together with its necropolis covers the area of over 400 ha. Due to the absence of modern constructions the site is suitable for large scale surveys using large spectrum of non-invasive methods. The town, which was most probably founded in the 7th or 6th century BC, rebuilt on the Hippodamian plane in the 3rd century BC and widely used for urban planning in Hellenistic period, was one of the important cities in ancient Cyrenaica. In the 4th century AD it became the capital of Roman province *Libya Superior*. Destroyed by earthquakes in 262 and 365 AD, it was rebuilt, and flourished also in the Byzantine period. However, it never regained its former brilliant position.

The aim of the project started in 2001 by the Institute of Archaeology of Warsaw University is to localize all archaeological remains, reconstruct original Hellenistic plan of the town and observe its later changes in the Roman and Byzantine periods.

Various remote sensing techniques and non-invasive methods were applied for this project:

- geodesic measurements with Total Station and GPS;
- aerial photo and satellite imagery analysis;
- digital terrain modeling with the use of geo-referenced digital images and kite-aerial photographs;
- geophysical survey with electric and magnetic methods;

Geodesic plan was prepared with the use of a TCR 407 power and a TC1103 Leica total station at the first stage of the project. Leveling measurements with a RTK Trimble GPS-set completed the plot as a contour map-vector layer.

Remains of over 700 buildings visible on the surface were measured, recorded and plot in AutoCad Map 3D 2007. Additional data base prepared as MySQL ODBC with main attributes of all objects allows us to work by queries from data base and graphical visualization of selected objects.

Raster images - satellite QuickBird images (resolution of 0.60 m - natural color and near infrared channel) and aerial-kite photographs were connected with the main AutoCad model. Vertical and oblique aerial photographs taken (from the distance of 20 to 350 meters) with the use of flow form kite with Minolta 200 M digital camera were rectified (using ground control points), transform to GeoTiff format and added (together with geo-reference file) as a layer of AutoCad 3-D model .

In this way the original plan of the town from Hellenistic Period has been reconstructed (Fig. 1). Possible differences between the theoretical model and the practical layout of the buildings and streets are verified by electric and magnetic geophysical surveys.

Resistivity measurements carried out in August and September 2006 were a continuation of the geophysical survey of the site started by magnetic prospection in 2005 (Małkowski *et al.* 2005). Electrical vertical soundings (VES) with the Schlumberger measuring system were used as the main method of the survey. Traverses 1 m apart with sampling points in the distance of 2 m in „en quence” grid (soundings made in even points on traverses with even numbers and odd on the ones with odd numbers) were traced in the field. Disposition of potential probes MN equal 1 m and current ones AB consequently 3, 5, 7, 10, 13 and 16 m allowed to observe changes of apparent resistivity to the depth of 0.75, 1.25, 1.75, 2.5, 3.25 and 4 m beneath the surface. Over 1260 soundings have been carried out in 6 squares. Coordinates for each square and numbering of points on X and Y axes were the same as prepared for the excavation, as well as for GIS and remote sensing analyses. That allowed to correlate geophysical maps (prepared as color maps and 3-D models of changes in apparent resistivity), with aerial and satellite photographs, and connect them with plans of structures excavated in trial pits and large scale excavation.

One of the most important aims of the 2006 activity was the survey of the central part of the site in a place suspected to be the Agora - the main square of the town in the Hellenistic, and probably also in the Roman and Byzantine periods (Fig. 2). A square 30 meters wide (probably paved) without any traces of architectural remains, but also ruins of buildings with deep foundations were localized here as result of electric survey. Anomalies caused by the last features start directly beneath the subsurface layer and go down to the depth of 4 meters, as can be seen on the set of slices and profiles presented in Fig. 3. The resistivity pseudo-tomography method used for the survey allowed us to collect data concerning mainly the condition of possible archaeological remains. We were able to find the most effective method for answering the question “how deep?” and in such layers lie the remains we were looking for. The next step should be to answer the question “where?” For this purpose the cheaper and less time consuming method of large scale magnetic survey seems to be the best solution. Preliminary magnetic measurements gave satisfactory results, and are planned for 2007 as the next step of non-invasive survey of the site.

REFERENCES

Małkowski/Mikocki/Misiewicz/
 Muszyńska/Jaworski 2005

W. Małkowski/T. Mikocki/K. Misiewicz/M. Muszyńska/P. Jaworski: Non-destructive surveys of an ancient city of Ptolemais at Cyrenaica (Libya). In: S. Piro (ed.), *Archaeological Prospection 2005*, Rome 2005, 195-196.

Krzysztof Misiewicz
 Institute of Archaeology and Ethnology
 Polish Academy of Sciences
 Al. Solidarności 105, 00 140 Warsaw, Poland
 geomis@iaepan.edu.pl

Miron Bogacki
 Wiesław Małkowski
 Tomasz Mikocki
 Monika Muszyńska
 Institute of Archaeology, University of Warsaw
 Ul. Krakowskie Przedmieście 1, 00-927 Warszawa, Poland
 wmalkowski@uw.edu.pl

ARCHAEOLOGICAL INTERPRETATION OF MAGNETOMETRIC DATA USING 3D MAGNETIC MODELING EXAMPLES FROM UKRAINE

Ksenija Bondar - Ivan Virshylo

Key words: magnetic modelling, archaeomagnetometry

Introduction. The paper deals with results from magnetometric survey and 3D magnetic modelling of some archaeological objects from the Bronze Age (14th-11th century B.C.) site Malopolovetske-2A (Kyiv region, Ukraine) and Scythian Belsk settlement (8th-3rd century B.C.) (Poltava region, Ukraine).

Magnetic model (MM) is a special case of physical-archaeological model (Koshelev 2004). It is composed of magnetometric and petromagnetic data and serves for archaeological interpretation of magnetic results. On the base of MM low-intensive archaeomagnetometric anomalies could be distinguished from those caused by topsoil heterogeneity. MM improves informativity of archaeological schemes as it characterizes archaeological object quantitatively.

Methods. Magnetometric survey on both sites was carried out on the level 0.5 m using IZMIRAN KM-8 magnetometer with sensitivity 0.1 nT. On the base of anomalous magnetic induction maps perspective areas for archaeological studying were defined. Some of them were excavated. All types of soil and archaeological materials

were sampled for laboratory measurements of main magnetic properties - magnetic susceptibility (k) and natural remanent magnetization (NRM). Magnetic susceptibility was also measured in the field on different depth levels with MS2 Bartington Susceptimeter with MS2D loop. All received data were used to create 3D first approximation magnetic models.

The process of magnetic modelling includes direct and inverse problem resolving.

Direct task algorithm performs magnetic field calculation using known magnetic parameters of object and/or soil. The cells of the model with definite values of model parameters (k and NRM) are organized in a regular grid. It allows working with heterogeneously magnetized and awkward-shaped objects. By comparing calculated magnetic field with observed one we receive additional information, which helps to reduce many-valuedness when resolving inverse problem. Inverse algorithm adjusts first approximation model parameters in order to obtain magnetic field similar to the observed one. With this purpose iterative optimization least-square method is applied (Bandy 1988). Optimization process stops when average difference between calculated and observed magnetic induction does not exceed given value (in our study 0.2 nT). By combining adjacent cells with similar magnetic properties we can visualize objects. The most convenient way to represent the results of modelling is effective magnetic susceptibility (k_{eff})

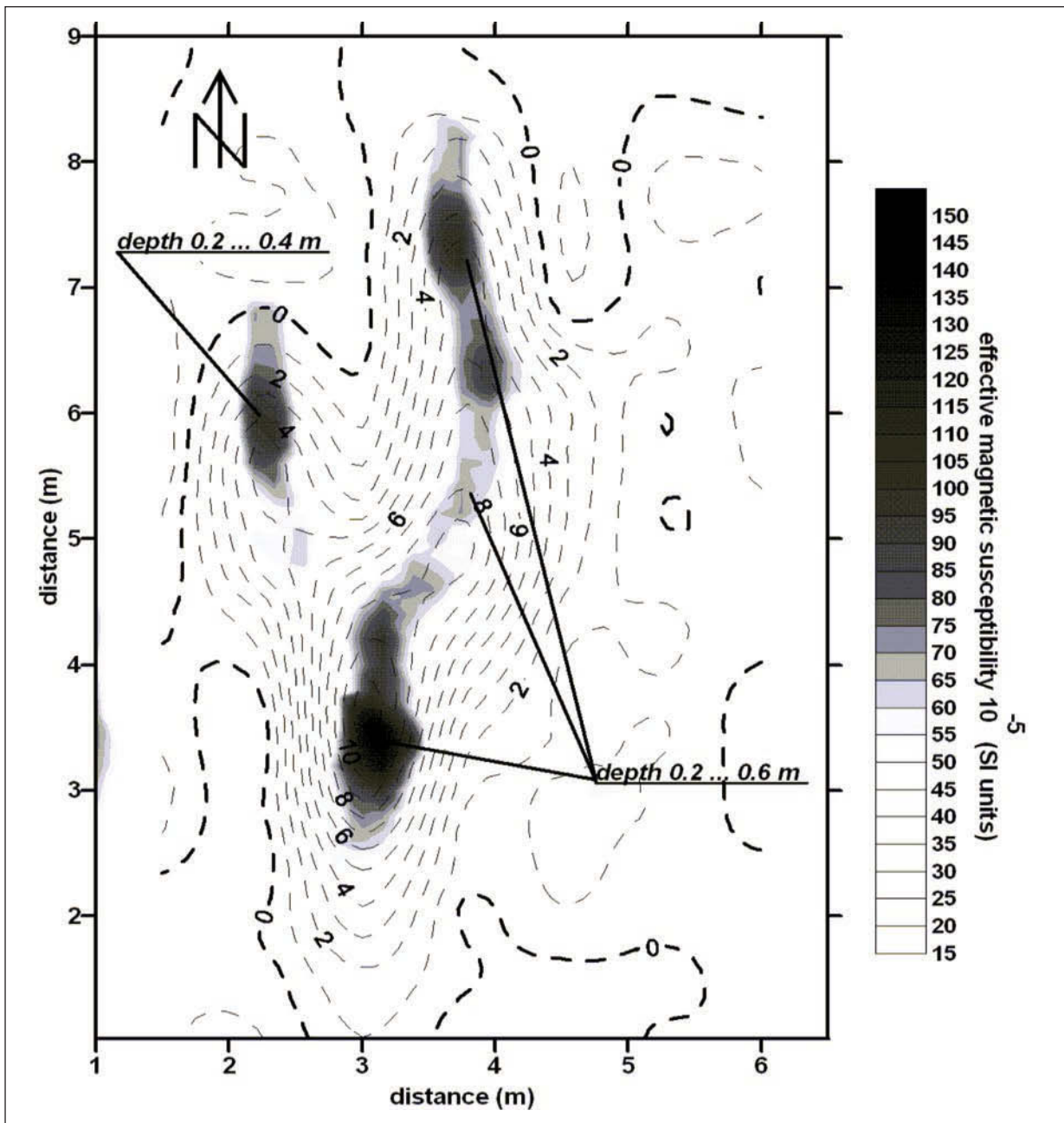

Fig. 1. Results of magnetic modelling from Malopolovetske 2A visualized as anomalous magnetic induction map in nT (dashed lines) overlying effective magnetic susceptibility plot on the depth 0.3 m. Vertical limits of predicted archaeological objects are signed.

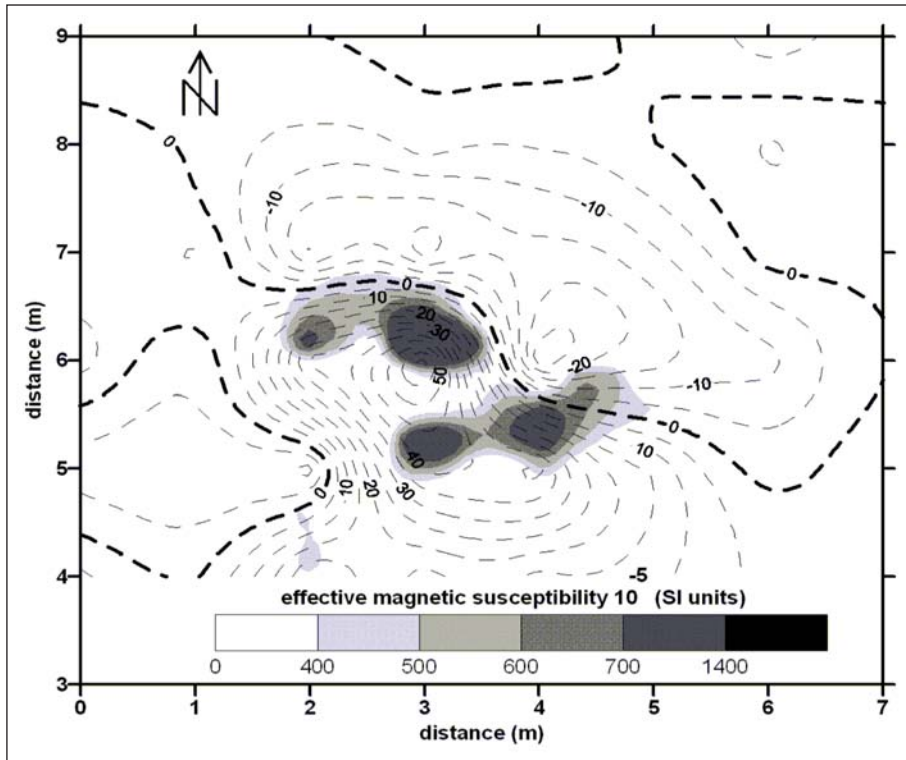

Fig. 2. Results of magnetic modelling from Belsk settlement, ash-heap №13, visualized as anomalous magnetic induction map in nT (dashed lines) overlying effective magnetic susceptibility plot on the depth 0.3 m. Vertical limits of predicted archaeological object (floor of the building) 0.3...0.6 m.

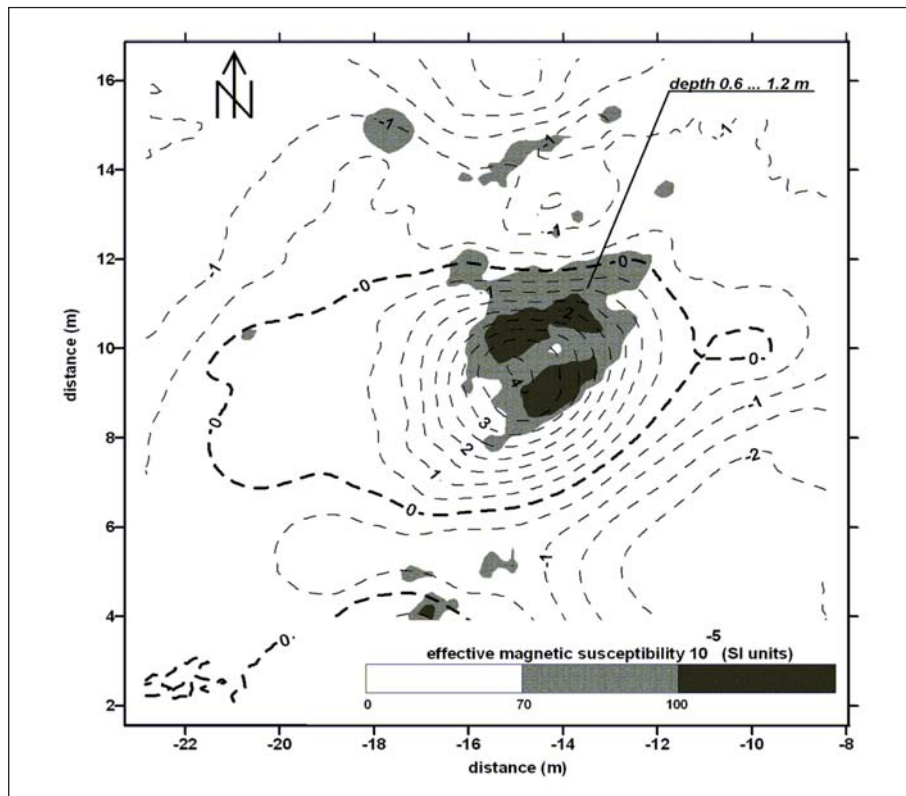

Fig. 3. Results of magnetic modelling from Belsk settlement, ash-heap №54, visualized as anomalous magnetic induction map in nT (dashed lines) overlying effective magnetic susceptibility plot on the depth 0.75 m. Vertical limits of predicted archaeological object (kiln?) 0.3-1.2 m.

plot on the given depth. Effective value is calculated as difference between k of object and enclosing loess or soil. Magnetic modelling was performed using specially developed software (Virshylo/Bondar 2007).

The method has some important benefits in comparison with others applied on archaeological objects (Levashov/Tsymbal 1984, Zavojsky 1978). It permits to work either with the whole soil layer or with small weakly magnetized objects and weak corresponding anomalies. The precision of representation of the object shape is limited by accuracy of the model only. MM is 3-dimensional. The method gives possibility to consider natural soil contribution by calculating effective magnetization of archaeological objects. The anomalous field fitting is carried out using induced and remanent components of total magnetization.

Results. The Bronze Age site *Malopolovetske-2A* is discovered with chernozem with $k=28-35 \times 10^{-5}$ SI units, $J_n=9-5 \times 10^{-3}$ A/m. Parent rock is loess with $k=14-23 \times 10^{-5}$ SI units, $J_n=9-5 \times 10^{-3}$ A/m. Objects excavated at this and neighbouring sites are fireplaces, ovens and earth-houses (Lysenko 2004). Burned clay and soil from oven demonstrate k values over 100×10^{-5} SI units. The magnetic modelling of perspective area showed complex of objects under composite anomaly with maximum intensity 11 nT (Fig. 1). Their depth was defined according to number of 0.2 m layers optimized by the program. As k_{eff} exceeds 150×10^{-5} SI units, we can consider them to be fireplaces. The most intensive source (kiln?) lies on the depth 0.2-0.6 m and has 1 m diameter.

Magnetic modelling has been applied to explain two curious anomalies observed on ash-heaps from Scythian *Belsk settlement*. The first one has intensity up to 55 nT and distinctive adjoint negative part (Fig. 2). According to k_{eff} plot, the source is highly magnetized object composed of two plates lying at the depth 0.3-0.6 m with k over 350×10^{-5} SI units. At this place a Scythian building was excavated (Zadnikov/Shramko 2006). Its floor is made of thick layer of ceramic shards covered with layer of burned clay. k_{eff} anomaly outlines a building with two rooms.

The other anomaly has 4 nT intensity and diameter 6 m (Fig. 3). The source has a round form, approx. 3 m diameter, deepened in loess down to 1.2 m. k_{eff} is $70-110 \times 10^{-5}$ SI units. When this value is added to natural k of enclosing loess, it gives total magnetic susceptibility $120-160 \times 10^{-5}$ SI units. It is common for burned clay, so the object is considered to be kiln.

Conclusions. The proposed technique and developed software for 3D magnetic modelling is a powerful tool for archaeomagnetometric data interpretation.

Heterogenic MM allows considering the archaeological object in context of natural sediments. The reliability of prognosis model increases as

- a) larger quantity of non-magnetometric information is involved in composing of first approximation model;
- b) observed values of vertical gradient of magnetic induction are used instead of calculated ones

REFERENCES

- Bandy 1988
Koshelev 2004
Levashov/Tsymbal 1978
Lysenko 2004
Virshylo/Bondar 2007
Zadnikov/Shramko, in print
Zavojsky 1978
- B. Bandy: Optimization methods. "Radio I svyaz". 1988. 127 (in Russian).
I. Koshelev: Magnetic prospection of archaeological sites. Kyiv, 2004, 337 (in Ukrainian).
S. Levashov/T. Tsymbal: Density heterogeneity modeling applying method of successive mass accumulation and overgrowth. Rep. Ac, Sci UkrSSR, Series. B, 1984, № 3, 1978, 16-19 (in Russian).
S. Lysenko: Supplement to the archaeological map of Fastiv area (1999-2004). Archaeological settlements from Fastivshina. (Kyiv region). FDKM 20-21, 2004, 85-152 (in Russian).
I. Virshylo/K. Bondar: Spatial magnetic modeling methodics and its archaeomagnetometric application. In: 8th Ural Young Scientists Conference on Geophysics, in print (in Russian).
S. Zadnikov/I. Shramko: Report on archaeological excavation on Western fortification of Belsk settlement in 2005. Institute of Archaeology NANU, 2006 (in Russian).
V. Zavojsky: Calculation of magnetic field from anisotropic 3D objects in magnetometric tasks. News Ac. Sci. USSR, Series Earth Physics. 1, 1978, 76-85 (in Russian).

Ksenija Bondar
Ivan Virshylo
Geological faculty
Kyiv Taras Shevchenko National University
Vasylkivska 90, Kyiv, 03022, Ukraine
ivvir@univ.kiev.ua

THE ROLE OF INTEGRATED ARCHAEOLOGICAL GEOPHYSICAL SURVEYS IN DEVELOPMENT-LED HOUSING AND ROAD AND COMMUNITY PROJECTS IN IRELAND

James Bonsall - Heather Gimson - Kevin Barton

Key words: integrated prospection, magnetic susceptibility, gradiometry, electrical resistance, development, infrastructure, tourism

The booming Irish economy relies heavily on public and private projects in the housing, road and community sectors. The Irish government places a high priority on the preservation of archaeological sites and monuments either by record or *in-situ*. Developers are obliged to assess the impact of potential and actual archaeology as part of the planning process. Geophysical survey on archaeological sites was first used in Ireland in the 1950s and until recent times has been largely carried out within an academic environment. In the past ten years geophysical survey has moved into the commercial environment and has become an integral part of the archaeological assessment of development sites using a combination of techniques and survey strategies.

As part of the archaeological assessment for a proposed housing development at Claremorris, County Mayo, a series of geophysical surveys were conducted on the site of a previously recorded archaeological monument. The survey area measures 100 m east-west and 50m north-south. The site had undergone intense agricultural activity and there were no surface traces of any underlying archaeology. The survey was commissioned to help determine whether the site was a nineteenth century landscape feature mistakenly classified as a ringfort or if it was another type of archaeological monument.

A reconnaissance, volume specific magnetic susceptibility survey carried out on a 5x5 m grid using a Bartington MS2 susceptibility meter (Fig. 1) revealed the presence of possible magnetic enhancement in the topsoil. Follow-up magnetic gradiometer survey using a Geoscan Research FM256 gradiometer (Fig. 2) with a 1x0.25 m line and station spacing, and electrical resistance survey using a Geoscan Research RM15 resistance meter (Fig. 3) and 0.5 m twin probe array with a 1x1 m line and station spacing revealed a series of anomalies. These anomalies were interpreted to be due to a sub-rectangular feature which may be the footprint of a medieval tower house. The integrated survey and interpretation also reveals the site to be larger in area than previously recorded with the recognition of a possible foundation robber trench, an annex and a number of possible ditch features. The geophysical survey confirmed the presence and possible extent of an archaeological monument and has provided the developer with data on which to base an excavation programme.

One of the growth areas in the use of archaeological geophysics in Ireland has been in road development. One challenge that has had to be addressed is the limited geographical area, or strip, of road corridor or roadtake, typically less than 40 m in width, within which a geophysical survey has to be carried out. It has been found that for interpretation purposes a minimum survey width of 40 m is necessary. This limited survey area gives rise to interpretation difficulties where sometimes it is difficult to identify coherent anomalies which can be unambiguously interpreted as being due to buried archaeological sources.

As part of the archaeological assessment for the National Route N7 road widening scheme in County Kildare, a magnetic gradiometer survey using a Geoscan FM 256 gradiometer with a 1x0.125 m line and station spacing, was conducted within the landtake that measured 120x40 m, adjacent to the existing road. A number of strongly enhanced ditches were discovered forming possible enclosures and semi-circular anomalies which partly correspond to visible, and previously unrecorded, linear earthworks on the site. This site is thought to represent the remains of a medieval monastic enclosure and associated internal features. A number of plough scars are also visible across part of the site.

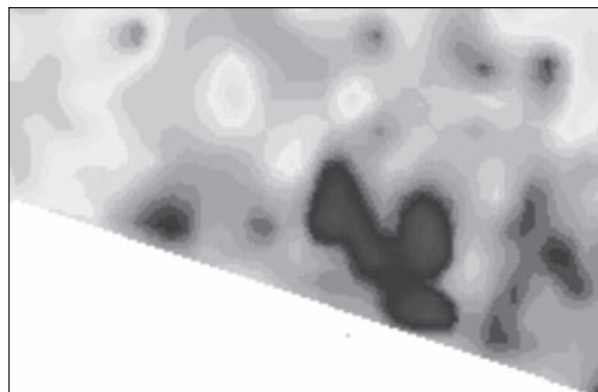

Fig. 1. Magnetic susceptibility in $\text{SI} \times 10^{-5}$ units, high values in black.

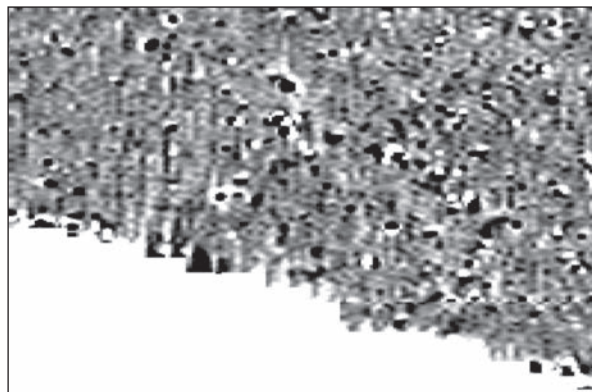

Fig. 2. Magnetic gradiometry in nanoTesla/0.5 m, positive gradient in black, negative gradient in white.

There are a large number of monuments in Ireland which are recognized by the State as being of archaeological importance but are in private ownership and thus do not have the benefit of State funding for renovation, maintenance or presentation to the general public. Owners and community groups often carry the financial burden of trying to preserve and present these monuments as part of tourism developments.

The sixteenth century Moygara Castle in County Sligo is in private ownership and was surveyed as part of a project leading to an archaeological conservation and development programme. The 50x50 m grass-covered interior, or bawn, of the castle was subject to an electrical resistance survey carried out using a TR Systems Resistance meter and 0.5 m twin probe array with 0.5 m line and station spacing. The survey identified a high resistance area to the south that has been interpreted as being due to a cobbled area. A raised platform to the north appears to have an internal low resistance ditch which encloses the possible high resistance foundations of an earlier tower or castle.

Archaeological geophysicists in Ireland are responding to the demands of current and future development projects by moving from research-based survey methodologies to rapid reconnaissance, processing, interpretation and reporting regimes. Future developments include multi-instrument survey platforms and in-field processing for quality control and survey planning purposes.

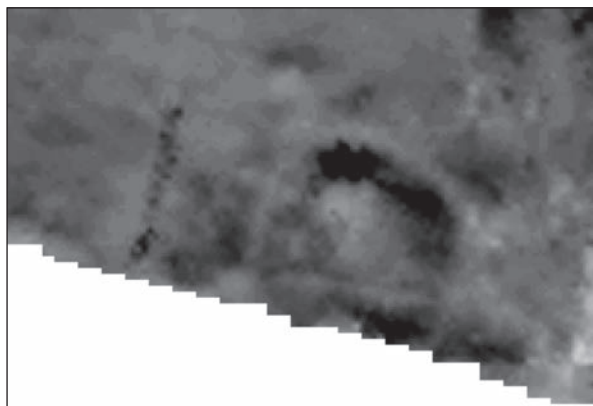

Fig. 3. Electrical resistance in Ohms, high values in black, low values in white.

James Bonsall
Heather Gimson
Kevin Barton
Earthsound Archaeological Geophysics
C/o Prospect House, Drumagh, Claremorris, County Mayo, Ireland
james@earthsound.net

INTEGRATION BETWEEN DIFFERENT REMOTE-SENSING SURVEYS TO CHARACTERISE AIALI ARCHAEOLOGICAL SITE (GROSSETO, CENTRAL ITALY)

Stefano Campana - Salvatore Piro - Cristina Felici

Key words: Aiali site, aerial photograph, gradiometric survey, GPR

Abstract

To enhance the knowledge of the Aiali site (Grosseto, Central Italy), finalised to the location and conservation of the unknown buried structures below the actual studied levels, a scientific collaboration between Landscape Archaeology, Department of Archaeology and History of Arts, (LAP&T), Università di Siena a Grosseto and the Institute of Technologies Applied to Cultural Heritage (ITABC-C.N.R.) was developed in 2005-2006 and is still in progress (Campana *et al.* 2006a).

The site has been studied analysing a set of vertical aerial photographs and making aerial surveys from 2002 to 2004, with the aim to locate buried structures. Large scale geophysical surveys employing a differential magnetic method and a GPR survey were carried out between 2004 and 2006.

Integrated Remote sensing surveys

As usually, we started working on the oldest available aerial photograph which in this case is the national coverage of 1954. Unfortunately, no features were visible on the historical flight because the site was used for olive cultivation. Nevertheless, the soil use changed to grain cultivation between 1950 and 1970. We did not find any features on verticals acquired in 1976, 1996 and 2001.

The site was detected in spring 2001 by aerial survey, (*Campana et al. 2006b*). From the end of May to the middle of June 2004, during the ripening season of the crop, the site was monitored from the air to record the aerial visibility of the cropmarks, by repeated flights at intervals of 2 and 4 days. This procedure allowed the clear identification of new traces, which had not been visible in earlier years (Fig. 1).

During 2004, a gradiometric survey collecting data at intervals of 0.50 m along profiles 1 m apart was carried out. The results showed a series of magnetic anomalies which match the traces visible on the oblique air photographs (Fig. 2). The clearer visible anomaly consists of a rectangular structure (possible roman villa) measuring about 70x25 m, oriented north-east/southwest, at each end of which are four square rooms 10x10 m across. A break in the magnetic data is caused by a disused iron pipe, which masks completely the possible presence of walls. On the evidence of the aerial photographs, which show continuity across the line of the pipe, we can assume that the below-ground archaeological deposits are essentially undisturbed. It is fair to suggest that in the absence of the pipe the gradiometer data would have produced equally positive results. Further magnetic anomalies can be seen in various parts of the field which were previously blank. Some tens of metres to the North-East and South-East of the main complex a series of linear anomalies, more or less aligned with the main structure, seems to represent an enclosure, perhaps with an entrance-way.

In 2006, high-resolution GPR surveys (conducted in collaboration with Dean Goodman, Archaeometry Laboratory, LA, CA, USA) were applied over four areas to test the potential of this technique. For the measurements, a GSSI SIR3000, equipped with a 400 MHz bistatic antenna with constant offset was employed. At each site, radar profiles were collected alternatively in reversed and unreversed directions across the survey grids. The horizontal spacing between parallel profiles at the site was 0.5 m. Radar reflections along transects were recorded continuously across the ground at 40 scan s⁻¹, with a stack = 3; along each profile, markers were spaced every 1 m to provide spatial reference. The gain control was manually adjusted to be more effective. All radar reflections within 50 ns (two-way travel time)

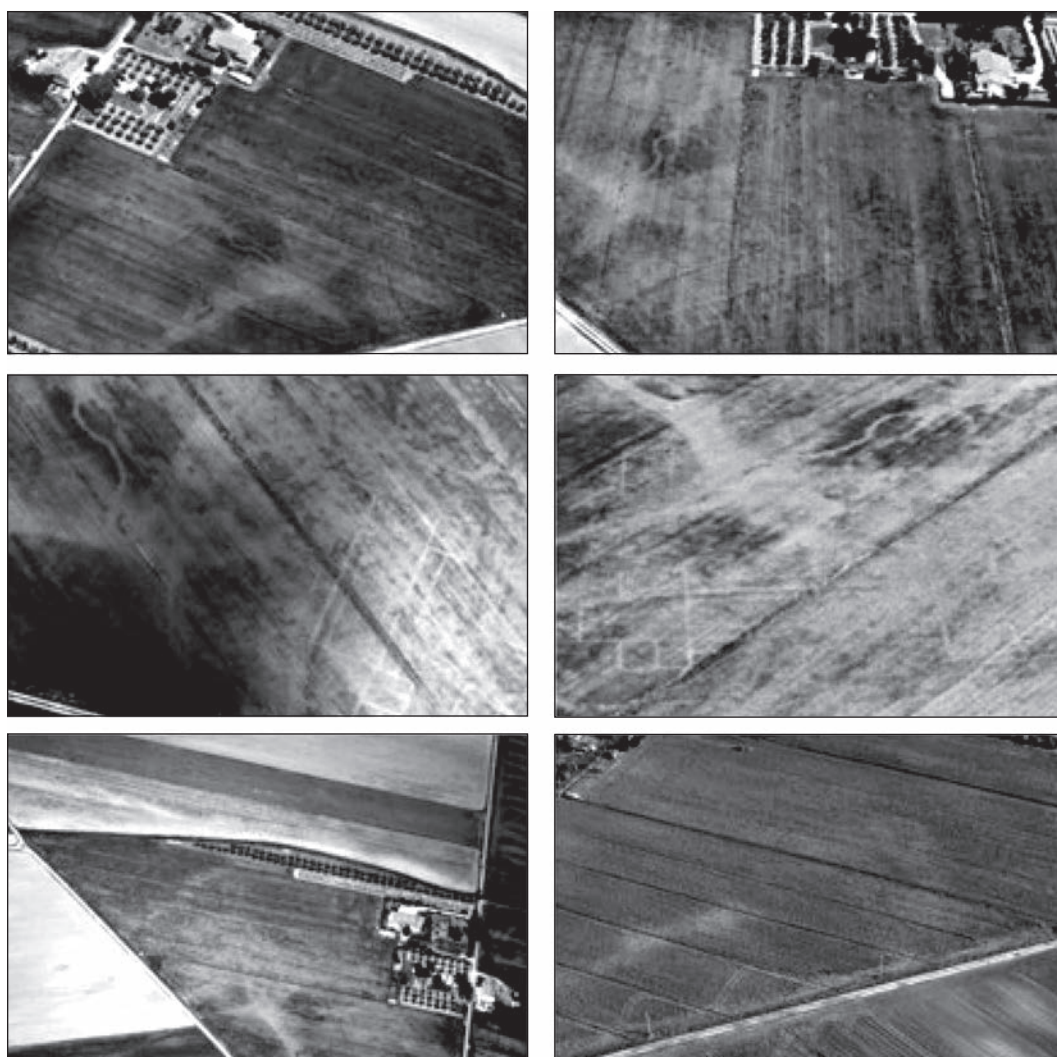

Fig. 1. Aerial oblique photograph of the site taken in different periods of 2004. Starting from above, left side: 25 June, 30 June, 4 July, 9 July, 13 July, 25 September.

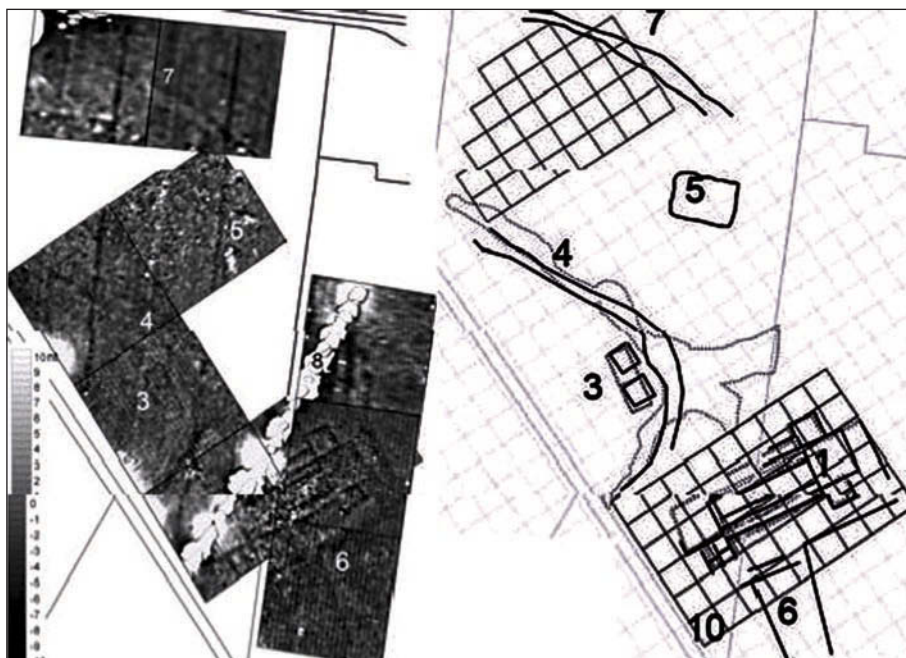

Fig. 2. Contour map of the gradient of Total Magnetic Field and archaeological interpretation.

time window were recorded digitally in the field as 16 bit data and 512 samples per radar scan. Referred to as time slice processing, the anomaly maps can be generated at various time/depth windows across the recorded radargram dataset. Time slice data were created using the spatially averaged square wave amplitudes of the return reflection. These averaged square amplitudes were then gridded using a Kriging routine (Piro *et al.* 2003; Goodman *et al.* 2001). Other line noises, parallel to the profile collection direction, were removed using a moving filter with customized threshold settings. Filter thresholds were set to signal levels just below the average reflections from buried Roman walls. In Area AB total number of 162 parallel profiles stretching S-N was collected with the instrument configuration indicated above. After the pre-processing, all collected GPR profiles were used to calculate the time-slices related to this area. Fig. 3 shows the time-slice in the depth range 1.05 - 1.38 m. In this slice a linear radar reflections are clearly visible. These anomalies are due to the presence of portion of walls still present in the ground.

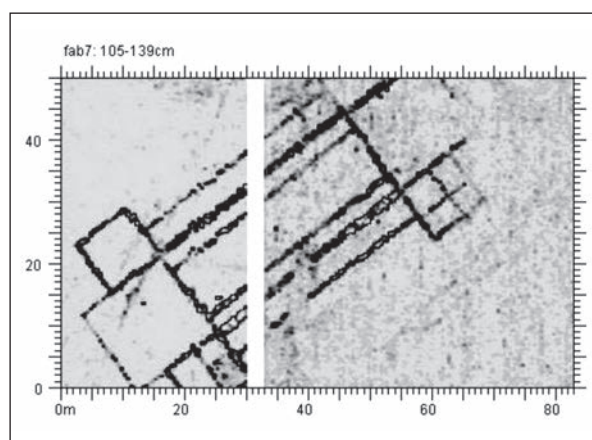

Fig. 3. Time-slice of the Southeast area of the site in the depth range 1.05-1.38 m. In this slice there are visible many features that can be interpreted as walls of the main building of the Roman villa still present under the ground.

REFERENCES

- Campana/Piro/Felici/Ghisleni 2006 S. Campana/S. Piro/C. Felici/M. Ghisleni: From space to place: the Aiali Project (Tuscany-Italy). In: Campana S., Forte M, (eds.). From Space to Place, proceedings of the II International Conference Remote Sensing in Archaeology, Rome 4-7 December, BAR International Series, 131-136.
- Campana/Francovich/Corsi/Pericci 2006 S. Campana/R. Francovich/M. Corsi/F. Pericci: Aerial Survey Project in Tuscany: years 2000-2005. In: Campana S., Forte M, From Space to Place, proceedings of the II International Conference Remote Sensing in Archaeology, Rome 4-7 December, BAR International Series, 497-503.
- Goodman/Nishimura/Piro 2001 D. Goodman/Y. Nishimura/S. Piro: High resolution ground-penetrating radar. In: Gaffney *et al.* (eds.). Forum Novum-Vescovio: studying urbanism in the Tiber valley. *Journal of Roman Archaeology* 14, 5-8, 20.

Piro/Goodman/Nishimura 2003

S. Piro/D. Goodman/Y. Nishimura: The study and characterization of Emperor Traiano's Villa (Altopiani di Arcinazzo, Roma) using high-resolution integrated geophysical surveys. *Archaeological Prospection* 10, 1-25.

Stefano Campana

Landscape Archaeology, Department of Archaeology
and History of Arts, (LAP&T),
Università di Siena a Grosseto
Via Roma 56
53110 Siena, Italy
campana@unisi.it

Salvatore Piro

Institute for Technologies Applied to Cultural Heritage
ITABC-CNR
Research Area Roma1 - National Research Council of Italy
P.O. Box 10 - 00016 Monterotondo Scalo, Roma, Italy
Salvatore.piro@itabc.cnr.it

Cristina Felici

Department of Archaeology and History of Arts, (LAP&T),
Università di Siena
Via Roma 56
53110 Siena, Italy
felicicri@unisi.it

GIACOMO BONI: A PIONEER OF THE ARCHAEOLOGICAL AIR PHOTOGRAPH

Giuseppe Ceraudo - Laura Castrianni

Key words: G. Boni, captive balloon, Roman forum

In order to fully comprehend the real contribution of military aerial photographs to the historical and archaeological research, it is necessary to start from the analysis of the period between the end of 1800 and the explosion of the World War First.

Giacomo Boni's experience represents the first application of aerial photography in archaeological research in Europe.

The Venetian architect was in 1898 entrusted by the Minister of Education Guido Bocelli with the management of a new excavation campaign in the Roman Forum, and availed himself, for the first time, of what this auxiliary science could offer to archaeology.



Fig. 1. The archaeological central area of Rome.

From 1899 to 1906, Boni carried out a series of ascents with a Brigata Specialisti's captive balloon kindly offered by the Corps of Engineers in order to realize a planoaltimetry relief concerning the valley of the Roman Forum and to document the excavations state advancement that from 1907 also concerned the area of Palatinum Hill.

The aerial photographs, taken from the height of 300 to 500 metres above sea level, are still an exceptional documentation, largely unpublished, of the progressive advancement of excavations, and an indispensable instrument of study and knowledge of the central archaeological area of Rome.

They are, moreover, the first example of this auxiliary instrument used in archaeology, so that they gain, in our opinion, an important documentary value concerning the techniques and the methodologies used, as an experiment, at the end of the century.

Giuseppe Ceraudo
Laura Castrianni
Università del Salento – Lecce
Via D. Birago, 64 – 73100 Lecce, Italy
giuseppe.ceraudo@unile.it

SATELLITE IMAGES AND GIS FOR THE ARCHAEOLOGICAL PARK OF CHAN CHAN

Francesca Colosi - Gabriele Fangi - Roberto Gabrielli - Roberto Orazi - Daniela Peloso

Key words: archaeological park, Quickbird satellite, laser scanner, 3D models, GIS

1. The operative project

The archaeological site of Chan Chan, located along the northern coast of Peru, represents the largest mud brick pre-Columbian settlement (14 Km²), and is characterized by three architectural typologies: the palaces or *Ciudadelas*, the *Huacas* or stepped pyramids, and the intermediate architecture.

Though it is on the UNESCO's World Heritage List and World Heritage in Danger List, Chan Chan is suffering a dramatic process of material and urban degradation.

In order to stop the process of decay the "Plan Maestro de Conservación y Manejo del Complejo Arqueológico Chan Chan" was approved by the President of the Republic of Peru in January 2000. The main objective of the plan was to integrate all the actions related to archaeological research, conservation and exploitation of the site with all the actions addressed to the promotion and the social development of its population.

The MIPE (Italian Mission in Perú) has been operating in Chan Chan since 2001, following the directions of the Plan Maestro and carrying out work of documentation and study both at architectural and territorial scale.

The main goals of the project are following:

- Planning of the Archaeological Park of Chan Chan;
- Preparing the restoration project of Palacio Rivero (one of the nine *Ciudadelas*);
- Creation of a Documentation Centre for the planning and managing of the Archaeological Park

2. Use of Quickbird satellite images for the study of the territory

The extensive settlement of Chan Chan cannot be analysed and studied without using great scale images as the high resolution ones from the Quickbird satellite (operative since 2002) used for the quantitative measurement of the deterioration and the detailed analysis of the territory.

The satellite image (kindly offered by Eurimage) shows us two different factors of territorial decay due to direct anthropic activity (new paths crossing architectural structures, spontaneous vegetation, uncontrolled agriculture) and to the aggressive approach to the archaeological area by the near town of Trujillo and its airport (Fig. 1).

The comparison between the aerial zenital picture of Palacio Rivero, which was taken in the seventies by the University of Harvard, and the Quickbird satellite image (May 2003) is particularly helpful for the evaluation of the degradation process: many structures of the second sector of the palace still visible in the Harvard picture have almost completely disappeared in the satellite image (Fig. 1).

With the aim to improve the quality of the information, a fusion was performed between the real colour and the panchromatic images and between the infrared and the panchromatic ones (useful for the study of soil and vegetation). The new images keep all the information of the real colour and the infrared shots but achieve the high resolution of the panchromatic one.

The new images show architectural alignments which are not visible on the ground, providing therefore an important tool for the identification of buried structures (Fig. 2).

3. Restoration of Palacio Rivero: geometric and photogrammetric documentation

The main objective of the present project is to use the case study of *Palacio Rivero* as an example of Chan Chan architecture to create an operating model allowing the execution and relative application of IT to all the phases of documentation, research, and restoration.

The geometrical survey of the palace was performed using different techniques: the Total Station for the still visible structures, the GPS for the contour lines of the surface generated by the deterioration of the walls and the aerial photogrammetry for the *Plataforma de Entierro* (Tomb of the King).

A part of *Palacio Rivero* regarding the wide area of warehouses and *Audiencias* was recorded using the Laser Scanner Callidus CP3200 (Trimble).

Following the usual procedure we have been able to create a 3D model that allows the creation of solid models from which it is possible to extract profiles, sections, elevations and all the other drawings needed for the planning of the restoration project (Fig. 3).

4. Creation of a Geographic Information System

During last year we started the construction of the GIS called "The Archaeological Park of Chan Chan" planned as a means of managing and valorisation of the archaeological complex and of its territory.

During the year 2006 the following data have been added:

- Cartographic data (maps at scale 1:5.000 and 1: 50.000; aerial photogrammetric survey by Harvard University in the years 1970-1973);
- Photographic data (Quickbird satellite image; aerial photos by Harvard University; aerial photo by MIPE of 2003-2005);
- Geometrical data (Topographic survey with Total Station, contour lines survey with GPS of Palacio Rivero, photogrammetric survey of *Plataforma de Entierro*; polygonal of the archaeological area).

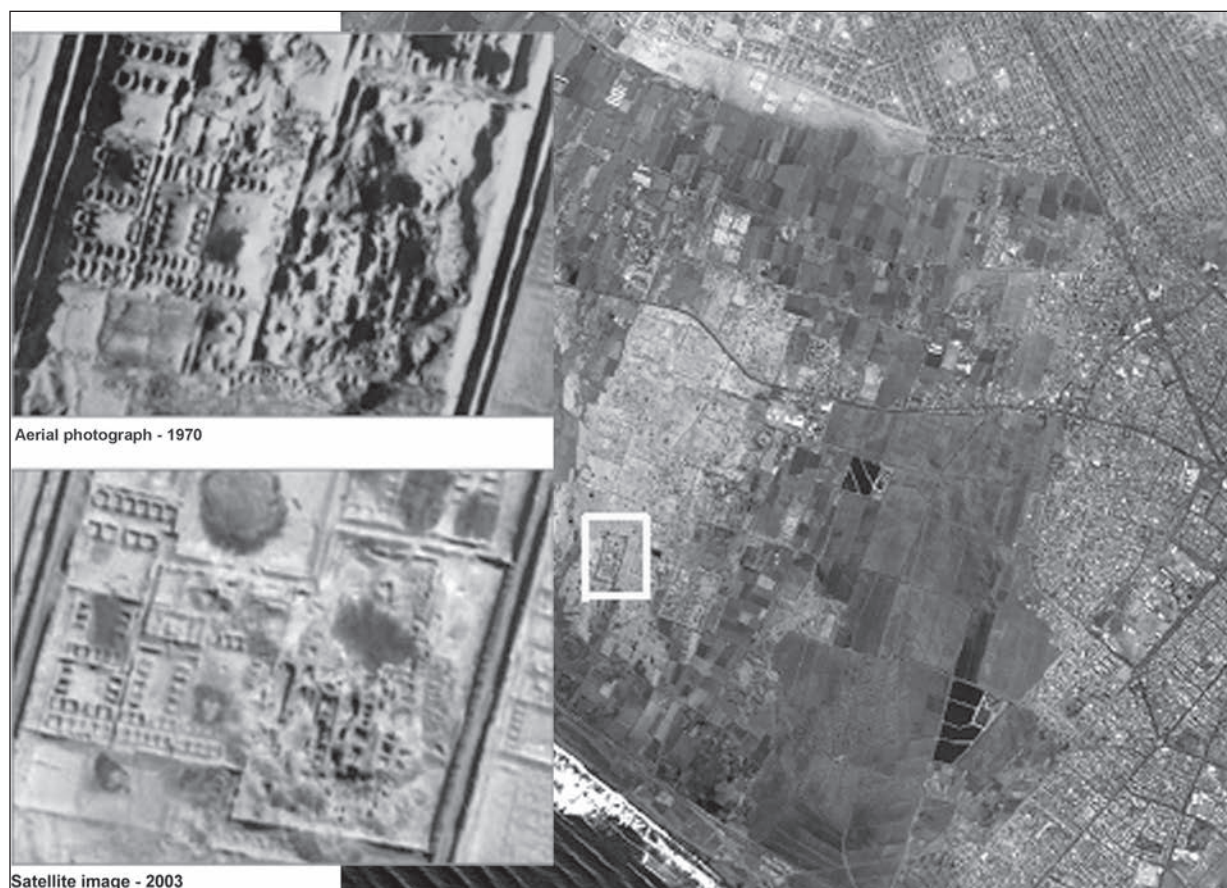

Fig. 1. Quickbird panchromatic image. On the left a zoom of the second sector in Palacio Rivero. Comparison between the aerial photograph (1970) and the satellite image (2003).

The final objective of such a system is the gradual creation of a multidisciplinary data archive that will allow the various research and conservation activities to be updated and to schedule and implement the improvement activities, as well as to regulate the complex economic activities related to the management of the archaeological complex (tourist flow, multimedia products, constraints and integration with the modern city).



Fig. 2. Quickbird image. Fusion between the real colour image and the panchromatic one. The image shows architectural alignments which are not visible on the ground (black arrows).

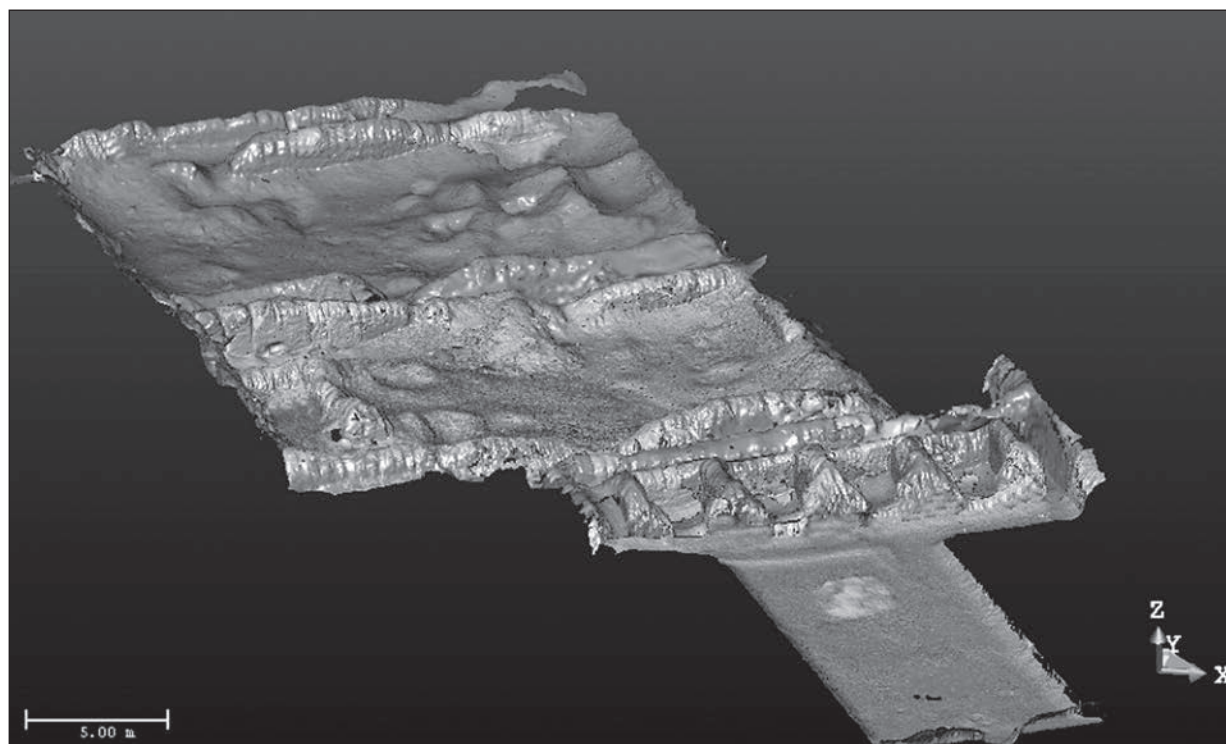

Fig. 3. Laser scanner survey. 3D representation of *audiencias* and warehouses in Palacio Rivero.

REFERENCES

- Andrews 1974* A. Andrews: The U-Shaped Structures at Chan Chan, Perú., *Journal of Field Archaeology* 1, 241-264.
- Colosi/Orazi 2003* F. Colosi/R. Orazi: Integrated Technologies for the Study, Documentation and Exploitation of the Archaeological Area of Chan Chan, Peru. In: *The Proceedings of the International Conference on the Study and the Conservation of Earthen Architecture - Terra 2003*, Yazd, Iran, 29 Nov.-2 Dic. 2003.
- Colosi/Orazi 2004* F. E. Colosi/R. Orazi: New technologies for the conservation of the Archaeological Park of Chan Chan. In: *The Proceedings LEHM 2004*, Trade fair and Conference on building with earth. Lipsia, Germania, 27-31 Ottobre 2004.
- Fangi/Malinverni/Schiavoni 2005* G. Fangi/E. S. Malinverni/A. Schiavoni: Integrated surveying techniques for the Archaeological Park of Chan Chan in Perú, XX International Simposium CIPA, 26 Sept.-1 Oct., Torino 2005.
- Kolata 1990* A. Kolata: The Urban Concept Of Chan Chan. In: Moseley M. - Cordy-Collins A. (a cura di) *The Northern Dynasties: Kingship and Statecraft in Chimor*, Dumbarton Oaks research Library and Collection, Washington 1990, 107-145.
- Moseley/Kent (a cura di) 1982* M. Moseley/D. Kent (a cura di): *Chan Chan, Andean Desert City*. University of New Mexico Press, Albuquerque 1982.

Francesca Colosi
Roberto Gabrielli
Daniela Peloso
CNR - Istituto per le Tecnologie Applicate
ai Beni Culturali (ITABC)
Via Salaria Km. 29,300 - C. P. 10
0016 Monterotondo St., Roma, Italy
francesca.colosi@itabc.cnr.it
roberto.gabrielli@itabc.cnr.it
daniela.peloso@itabc.cnr.it

Gabriele Fangi
Università Politecnica delle Marche - DARDUS
Dipartimento di Architettura, Rilievo Disegno Urbanistica e Storia
Via Breccie Bianche, sn, 60100 Ancona, Italy
g.fangi@univpm.it

Roberto Orazi
Italian Mission in Perú
<http://www.peruan-ita.org/2004/mipe.htm>
roberto.orazi@gmail.com

INTEGRATION OF ARP AND AMP FOR RESCUE ARCHAEOLOGY: EXAMPLE OF A 50 HA PROJECT

Michel Dabas - X. Cassassolles - M. Chemin - L. Conte - A. Favard - J. M. Valet - F. X. Simon

Keywords: *GIS, resistivity profiling, magnetics profiling, trial trenches, rescue archaeology*

Archaeological exploration of buried targets with non destructive techniques is becoming more and more important but has to face a specific problem of spatial resolution: most of our cultural heritage is buried in the first meter below the ground surface and in order to obtain a good resolution of images, we need a ground resolution of the order of several decimetres. Exploration of areas of more than several hectares with this resolution needs a lot of time and money and is not generally compatible with today constraints of Rescue Archaeology (motorways and railways planning, industrial zones or housing estates): the two main methods mostly used for archaeological investigation, that is resistivity and magnetometry are generally hand operated and the surfaces that can be covered per day are - for a resolution of 0,5 m - of maximum 1 ha for magnetometry and 0,3 ha for resistivity.

Development of towed systems using standard sensors but integrating them into a more complex acquisition scheme can be seen as a new field of development. New technologies like GPS (dGPS or RTK-GPS), integration of hybrid technologies (UMTS+ GPS) for example, Inertial Navigation Systems (INS), auto-guidance systems, real-time GIS for quality checking and integration, real-time processing, open clearly new fields of application for the geophysicist and the archaeologist. For example, mass production of GPS has made this technology affordable for the surveyor and now discards any previous time-consuming topography. This enables lowering of the prices and makes possible, in particular to archaeology, a massive use of sub-surface geophysics.

For 6 years, we have been developing towed electrical systems for agriculture applications (GEOCARTA sa.), the resulting ARP© system was released for Archaeology in 2003 and enables the survey of more than 6 ha per day (resolution of 0,5x0,5 m). Using the same home-made hardware and software, we developed in June 2005 a continuous magnetic system: the AMP© (Automatic Magnetic System) system (more than 10 ha per day). The next step (*Hulin et al.*, p. 192 in this journal) is the integration of both sensors and/or integration of EM sensors.



Fig. 1. Digital Elevation Model (1 m) obtained with ARP(c) and Aerial Photo.

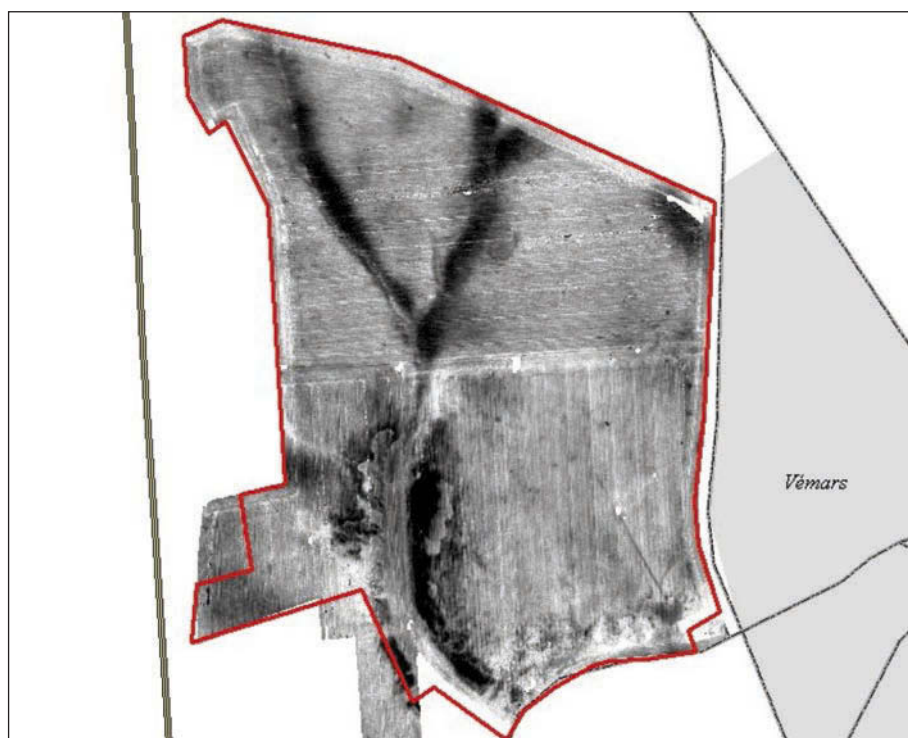

Fig. 2. Apparent Electrical Resistivities from ARP(c) channel2 (1m investigation depth).

Application of both technologies integrated within a home-made GIS (Geocarta Office) will be presented in a project for Rescue Archaeology over an area of 50 ha: the VEMARS project.

Evaluation of archaeological potential in Rescue Archaeology in France is generally done by spot observations like trenches and field walking. The latter method can be successful but only if archaeological artefacts are near the surface and if the land has been ploughed recently. Trenches are of course very destructive and can be opened over a very limited extent of the total area to be studied, generally between 5 and 12%. Moreover, this process implies that the land is already purchased, which often implies too short time period between evaluation and diggings.

Use of an integrated non-destructive approach before the trial trenches has proved to be valuable in the VEMARS Project (GSE-Prologis). At the beginning of this project we integrated different layers of information like: DEM, aerial photos since 1946, old maps dating from 1780, napoleonian cadasters, land surveyor data, even a sketch of the coming industrial park.

ARP and AMP surveys were done within a month over the 50ha plots and interpretation was performed using all existing data. The next month, trial trenches were dug and confrontation of interpretation of geophysical data with field observation in the trenches was operated. It was found that in this specific context, nearly all archaeological structures were discovered by geophysics and specifically by the ARP system. Some structures were even discovered without doubt by geophysics and not found by archaeologists ("ghost anomalies"). Reinterpretation of some archaeological structures was also possible using the information brought by geophysics between the trial trenches.

In conclusion, the combined use of ARP, AMP data and trial trenches has greatly enhanced the archaeological knowledge of this zone. The gain in terms of time of operation (50 ha in one month) compared to a manual approach has been estimated to a minimum of 20. The knowledge of the sub-surface was also beneficial to other partners involved in this project like civil engineers or hydrologists, and shows that the benefits and consequently the cost of such an integrated survey can be supported not only by archaeologists.

REFERENCES

- Dabas/Hesse/Tabbagh 2000* M. Dabas/A. Hesse/J. Tabbagh: Experimental resistivity survey at Wroxeter archaeological site with a fast and light recording device, *Archaeological Prospection* 7, 107-119.
- Dabas/Guyard/Leppert 2005* M. Dabas/L. Guyard/T. Leppert: Gisacum revisité: croisement géophysique et archéologie, *Dossiers de l'Archéologie*, n° spécial Géophysique et archéologie, 308, 2005, 52-61, 79.
- Dabas/Blin/Bernard 2005* M. Dabas/O. Blin/C. Bernard: Les nouvelles techniques de résistivité électrique employées dans la prospection de grandes surfaces en archéologie, *Les Nouvelles de l'Archéologie* 101, 24-32.

Michel Dabas
TERRA NOVA
16 rue du Sentier, F 75011 Paris, France
dabas@geocarta.fr

DISCOVERING MEDIEVAL SZAMOTUŁY (WIELKOPOLSKA REGION): A MULTIDISCIPLINARY APPROACH

**Mirosława Dernoga - Tomasz Herbich - Ryszard Pietrzak -
Włodzimierz Rączkowski - Dawid Święch**

Key words: aerial photography, fieldwalking, magnetic prospection, resistivity prospection, Wielkopolska

There being no existing charter, and due to some enigmatic reports found in the written sources, the issue of the origins of Szamotuły, a town in the Great Poland (Wielkopolska region), has been widely debated and various, often contradictory interpretations have been put forward. Most historians have been inclined to seek the town's beginnings in a market charter granted by Przemysł I some time before 1257 to a village located about 2.5-3 km north-northeast of the modern town. The reasoning was based on a document of 1284, issued by Przemysł II, confirming the market charter granted to Tomisław of Szamotuły. Somewhat later documents refer to a church with graveyard, which is said to have existed in the village until the 17th century. It is presumed that voivode Tomisław granted a town charter to Szamotuły at the end of the 13th century, and the common opinion has been that this foundation was located on the spot of the modern city (Jurek 2006).

Identification of the location of this church dedicated to St. Martin and the market settlement proved to be challenge for local historians. Archaeologists surveyed the area in search of traces of the Old Szamotuły, closing in on the area east of the Sama river, about 2.5 km north-northeast of the modern town, as one holding the greatest promise. The first archaeological excavations were carried out in 1995, but the trenches could not be positioned anywhere but on the outskirts of cultivated fields. Excavations carried out on an area of 270 m² revealed prehistoric occupation, as well as remains of a 14th century house (Paulak/Pietrzak 2002). The results were interesting, but hardly univocal.

Non-invasive prospection methods were suggested in an effort to overcome organizational and financial obstacles. Aerial photography was first considered and the area for aerial survey was determined, based on archaeological fieldwalking and an analysis of the distribution of individual finds of metal objects. Working on the assumption that wall foundations should be revealed by cropmarks, the investigators hoped to localize the site of the St. Martin Church. The reconnaissance flight in July 2005 failed to provide the expected results. A repeated flight in 2006, however, brought entirely different and startling results.

The long-lasting spring drought of 2006 was instrumental in making cropmarks tell their story. The difference in soil structure showed up exceedingly well in the colouring and relative height of ripening crops, tracing a distinct plan of the old town in the aerial shot (Fig. 1). A market square lined with architecture on all sides can be discerned in the centre. Running along the western side is a street which continues both northward and southward. The section to the south is also distinctly lined with houses on both sides.

There can be no doubt looking at this picture that we are dealing with a chartered town. The concept of the 13th-century town of Tomisław being located on the spot of the modern town has been proved wrong. It seems now that development proceeded in three stages. The first one was a village functioning from at least the 12th century, huddling around the church of St. Martin; it was granted a market charter before 1257. Next was the town chartered by Tomisław some time between 1284 and 1296. It was founded on new ground, possibly near the village, following a typical layout. It was destroyed most likely in the second half of the 14th century, this resulting in a second charter, granted to the town that underlies the modern Szamotuły at the end of the 14th century.

The discovery of this town did not resolve all issues connected with the origins of Szamotuły. New research questions appeared. For example, how did the market village with St. Martin's church relate to the late 13th century town? What was the extent of this town? Was there any architecture in the middle of the market square (the cropmarks in this area were not very distinct)? Where did the owner of the town reside, considering that towns were usually located in the vicinity of such residences?

Other non-invasive surveying methods, i.e. magnetic and electrical resistivity prospection, were called in to answer these questions. During the first stage of the research (December 2006) an area of 1.88 ha was surveyed by the magnetic method, covering 90% of the market square, the architecture on the eastern and northern side of the market and part of the buildings on the western and southern sides. The resistivity method was applied over an area of 0.48 ha, covering the northeastern corner of the market square and adjacent buildings. The magnetic map reflected all the architectural remains that the crop marks in the aerial photo showed (Fig. 2A). Moreover, the magnetic scanning recorded a series of features which had not been delineated by crop marks, but which had much higher amplitudes of magnetic field intensity values compared to the structures interpreted as houses. Considering the position of these anomalies mainly in the back and middle parts of particular plots, they were identified as settlement structures.



Fig. 1. Aerial photograph of the site. Outlined area covered by the magnetic survey. Photo W. Rączkowski, 3 July 2006.

The high amplitude of values (falling in the range $-30/+110$ nT) leaves little doubt that the corresponding features are composed of heavily burnt material like burned clay, ashes or cinders. The area of the square itself corresponds to stable magnetic field intensity values (changes in the range 2 nT), which are similarly stable outside the line of architecture adjoining the sides of the square.

On the resistivity map this architecture surrounding the market square is reflected by lowered resistivity values (below 100 ohms; Fig. 2B). A series of anomalies (with lowered values, down to 50 ohms) should be seen as corresponding to house vestiges, but the image of particular features is considerably less distinct compared to the magnetic map results. On the other hand, prospection by this method revealed features of raised resistivity (up to 200 ohms) within the square itself. Could these possibly be stone cobbles (or gravel perhaps)?

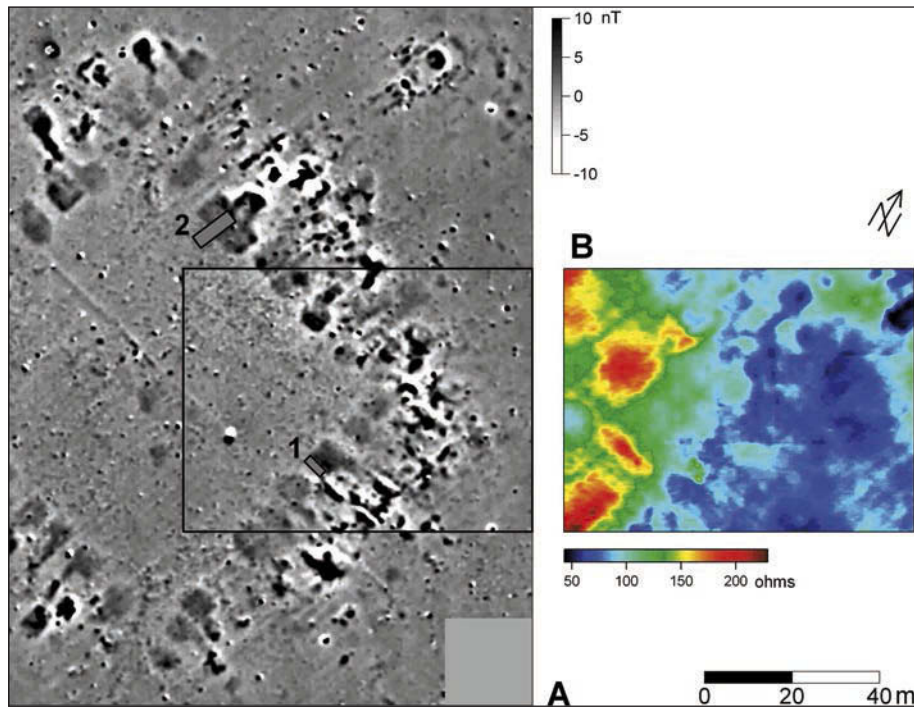

Fig. 2. A. Magnetic map. Gradiometer Geoscan Research FM36. Sampling grid 0.25x0.5 m, interpolated to 0.25x0.25 m. Low pass filter. Dynamics $-6.8/+10$ nT. 1 - Trench 1; 2 - Trench 2. Frame marks area covered by the resistivity survey. B - resistivity map. Resistivity meter Geoscan Research RM15. Twin probe array; spacing of mobile probes 0.5 m; spacing of remote probes 1.5 m. Sampling grid 0.5x1 m, interpolated to 0.5 m. Low pass filter. Dynamics 43-230 ohms.



Fig. 3. Trench 2, north side. Section at the point of the contact of two houses. Photo M. Dernoga.

Testing by excavation was required in order to determine the chronology of the discovered complex, this in view of the decision to register the site of the town as historical heritage. Trench 1 (2x5 m) was traced by the eastern side of the market square; the bigger Trench 2 (3x10 m) explored the northern side. Features located in the former of the two trenches included a small cellar and two pits qualified as remains of industrial installations (furnaces). Trench 2 proved much more interesting as it revealed the point of contact of two houses, apparent immediately under the topsoil. In section these features appeared dip-shaped with flat bottom (Fig. 3), reaching a depth of approx. 170 cm. The floors in these buildings were of tamped earth. Impressed wood in chunks of clay is indicative of walls made of beams and plastered with clay. No traces of posts of the structural kind were observed. The fill consisted of remains of the clay floor, large chunks of charcoal and a layer of burning that testifies to a conflagration destroying the building. Pottery was abundantly represented in the buildings. In terms of chronology, it is quite uniform, dating from the second half of the 13th through the end of the 14th century.

The discoveries satisfy a broader interest than just that of the residents of Szamotuły. The results of the investigations demonstrate beyond doubt that we are dealing with a medieval town foundation that preserves a layout undisturbed by later occupation. Thus, it constitutes excellent comparative material for studies of the origins of medieval towns in Poland and most likely in all of Central Europe as well.

Funding for the aerial survey came from the international project *European Landscapes: Past, Present and Future* (www.muzarp.poznan.pl/EuLandscapes/). The geophysical prospection was financed by the Wielkopolski Province Conservator in Poznań.

BIBLIOGRAPHY

Jurek 2006

T. Jurek: Średniowieczne Szamotuły i ich dziedzice. In: A. Gąsiorowski (ed.), Szamotuły. Karty z dziejów. Szamotuły 2006, 11-64.

Pawlak/Pietrzak 2002

P. Pawlak/R. Pietrzak: Późnośredniowieczny obiekt mieszkalny z Mutowa, gm. Szamotuły, stan. 5. In: H. Machajewski, R. Pietrzak (eds.), *Badania archeologiczne Ziemi Szamotulskiej I*, 2002, 199-228.

Mirosława Dernoga

Office for Monuments Preservation in
Wielkopolska voivodship,
Department in Piła
ul. Śniadeckich 46, 64-920 Piła, Poland
soz.pila@poznan.uw.gov.pl

Tomasz Herbich

Institute of Archaeology and Ethnology,
Polish Academy of Sciences
Al. Solidarności 105, 00-140 Warszawa, Poland
tomasz.herbich@gmail.com
herbich@iaepan.edu.pl

Ryszard Pietrzak

Patrimonium Foundation
ul. Wodna 27, 61-781 Poznań, Poland
ryszard.pietrzak@patrimonium.pl

Włodzimierz Rączkowski

Institute of Prehistory, Adam Mickiewicz University
ul. Św. Marcina 78, 61-809 Poznań, Poland
wlodekra@amu.edu.pl

Dawid Święch

Goleszów 187, 39-300 Mielec, Poland
david_swiech@yahoo.com

THE USE OF REMOTE SENSING IN ARCHEOLOGY: THE EXAMPLE OF CAPESTRANO PROJECT

Donatella Dominici - Filippo Del Guzzo

Key words: remote sensing, photo-interpretation, satellite images, new technologies

This study aims to investigate Capestrano's archaeological site (Abruzzo) with geomatics techniques to realize a precise cartographic mapping and a three-dimensional description of the structures. The QuickBird panchromatic and multispectral satellite high resolution images are used for a cartographic mapping using GCP (Ground Control Point) surveyed with GPS techniques. Characteristics and identification of buried archaeological structures on multispectral images is carried on with analysis on the spectral features changes using supervised classification (Mahalanobis distance, Spectral angle) and testing low and high pass filters or template filters. From the archaeological point of view, the aim of this paper is to present one of the most reach archaeological areas in Abruzzo (Central Italy) especially known for the famous find of the Statue of the 'Capestrano Warrior'. The first step of the work is to define

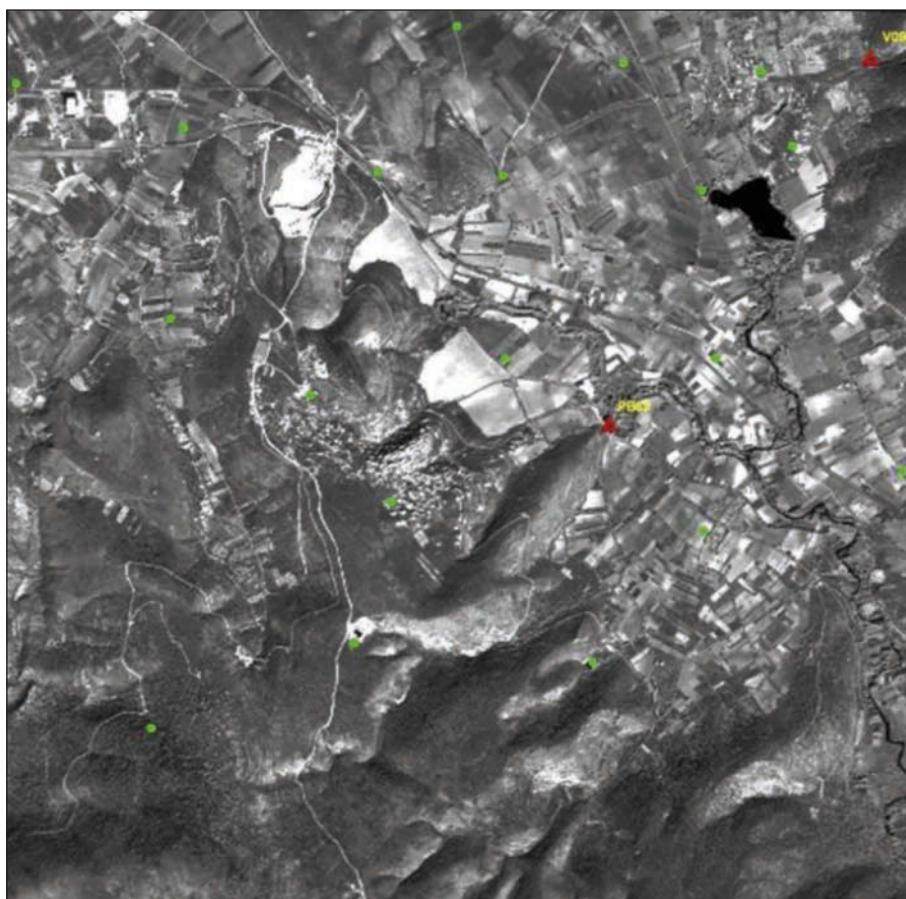

Fig. 1. High definition satellite image of the area of Capetrano (Italy).

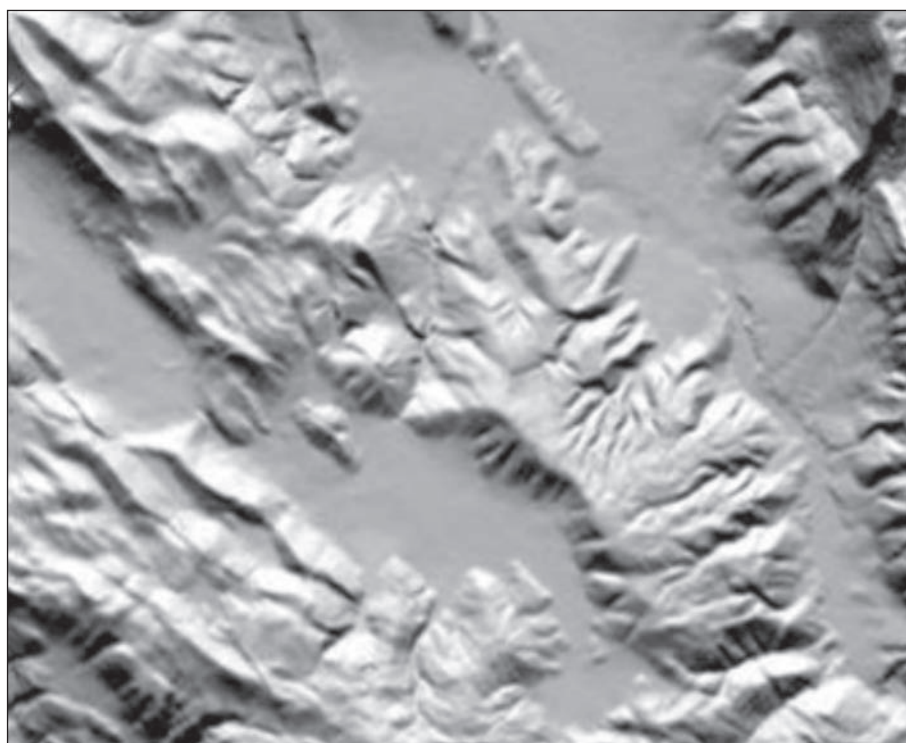

Fig. 2. Digital terrain model of Capetrano Valley.

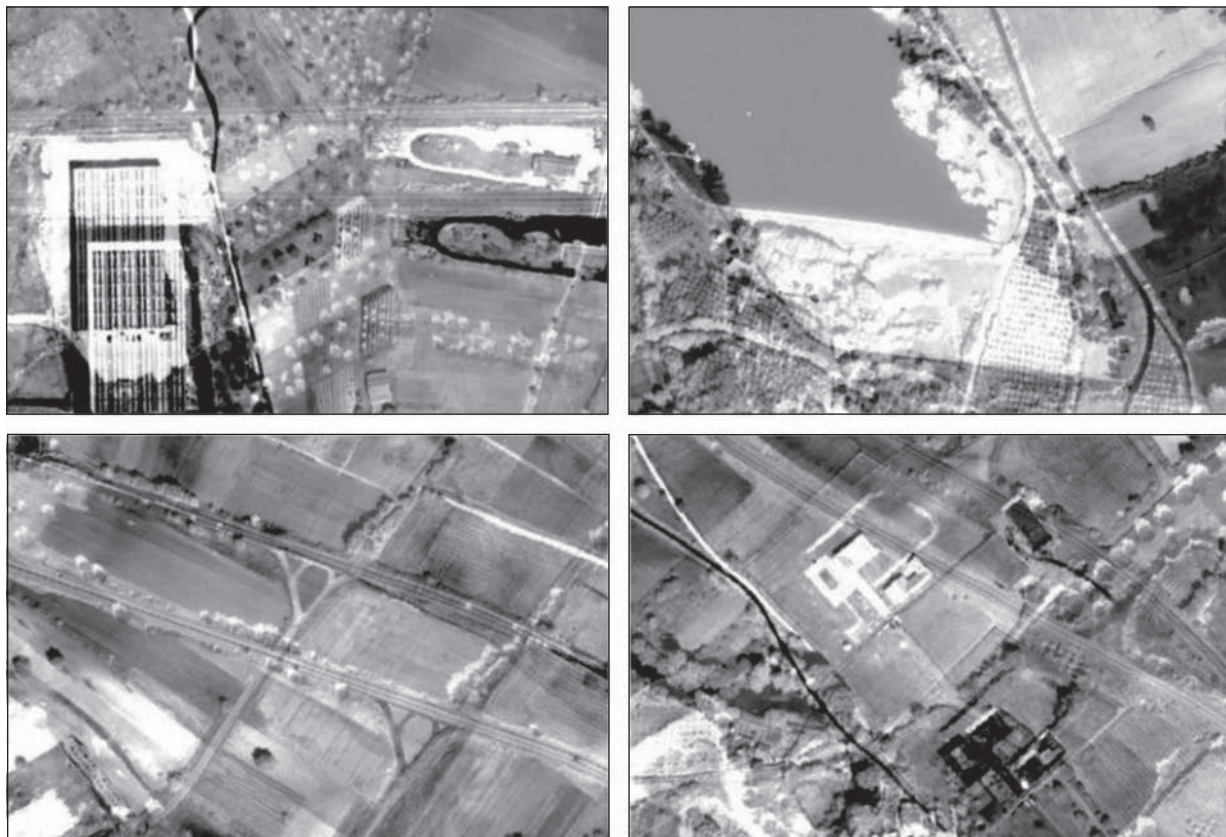

Fig. 3. Caestrano project: parallel imaging.

the methodologies of the research in order to analyse homogeneously all the archaeological evidences: for this stage the new techniques of remote sensing has been used to interpret and mark all the so called "anomalies" up to obtain a sort of thematic map of the archaeological evidences. The second level of the paper is focused on the analysis of these anomalies in order to understand the features of the finds, presenting and discussing field methodologies, quantitative and qualitative data of the project. Moreover, the possibilities of the use of high definition satellite images as topographic bases for a multi-layer GIS (archaeological, geological, geo-physical, historical) will be discussed, in particular and especially in combination with detailed cartography, aerial photography and 3D modelling.

Donatella Dominici
Filippo Del Guzzo
Facoltà di Ingegneria, Dipartimento di Urbanistica e Topografia
Università dell'Aquila, Roio, L'Aquila, Italy
dominici@dau.ing.univaq.it

GEOINFORMATIONAL MONITORING OF ARCHAEOLOGICAL MONUMENTS IN THE STAVROPOL REGION

Aleksey Dovgalev

Key words: GIS, monitoring, aerial photography, satellite photography, Stavropol Region, Russia

Anthropogenic pressure that leads to destruction of archaeological monuments creates new demands to protection of historic heritage, which are impossible to meet without up-to-date IT solutions - the geo informational technologies.

The threat of destruction for archaeological monuments of the region compels to search the most efficient ways of protecting the historical heritage and monitoring their condition.

Recently, State Unitary Organization “Nasledie” (affiliated to the ministry of culture of the Stavropol region) has been using the GIS increasingly to research and preserve historic and cultural heritage as well as to carry out monitoring research.

Monitoring archaeological monuments involves a thorough analysis of various factors that influence their condition.

Currently “Nasledie” is developing a uniform monitoring system of archaeological monuments of the Stavropol region based on GIS in order to meet the needs of cultural protection of the region.

Methodology was tested and improved on a testing site near Budenovsk (a town in the Stavropol region). Due to its geographical position the location is abundant with archaeological monuments of various types. Numerous



Fig. 1. Location of the Stavropol region.

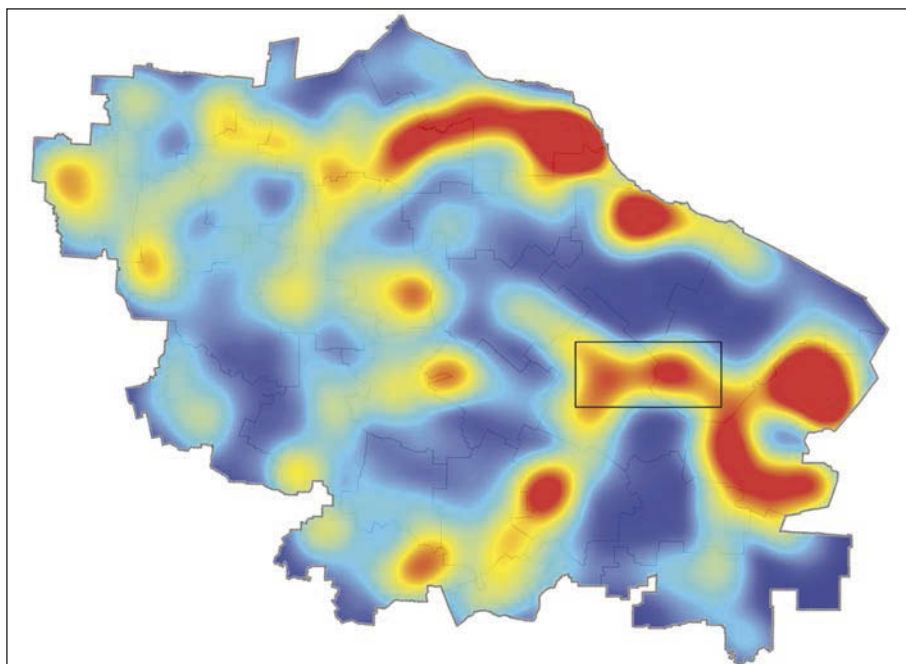

Fig. 2. Density of archaeological monuments in Stavropol Krai.

kurgans, ground burials and settlements dated from the Early Bronze (3rd-2nd millennium BC) to the late middle Ages are constantly being destroyed due to farming and construction.

One of the most interesting archaeological sites, the "Madjary" settlement is located here. It is the site of the golden horde city of Madjar. This historical monument is of national significance.

Following materials were used as an informational foundation of the research:

- topographic maps to the scale of 1 : 25 000, 1 : 100 000
- data of planned aerial photography reflecting area situation in 1980, 1987 and 2001
- satellite photography received from the satellite Resurs F1 with camera KFA-1000 in 2000 and with CORONA KN-4B in 1972

GIS and RS technologies help to detect the destroyed archaeological objects and to identify archaeological monuments partially destroyed or under a threat of destruction, as well as to carry out monitoring examination.

For the territory of the Stavropol region a cartographic foundation was produced, consisting of topographic maps to the scale of 1 : 25 000 (948 units), 1 : 100 000 (80 units). To geo encode the basic (array) layers a coordinate conversion matrix was built containing coordinates from 200 to 400 points evenly distributed over the entire array. At the same time precision of the geo encoding of the cartographic foundation was measured. It was oscillating between 0,9 m and 3-5 m (transformation was produced with polynom of the 3rd grade). The purpose of transformation of the cartographic material was correction of errors that appeared through non-linear deformations of foundation on which the initial data was printed (paper) as well and those of the scanner. As a result of geometrical transformation the basic cartographic foundation was supplement with coloured polyzonal satellite photographs KFA-1000 (20 items).

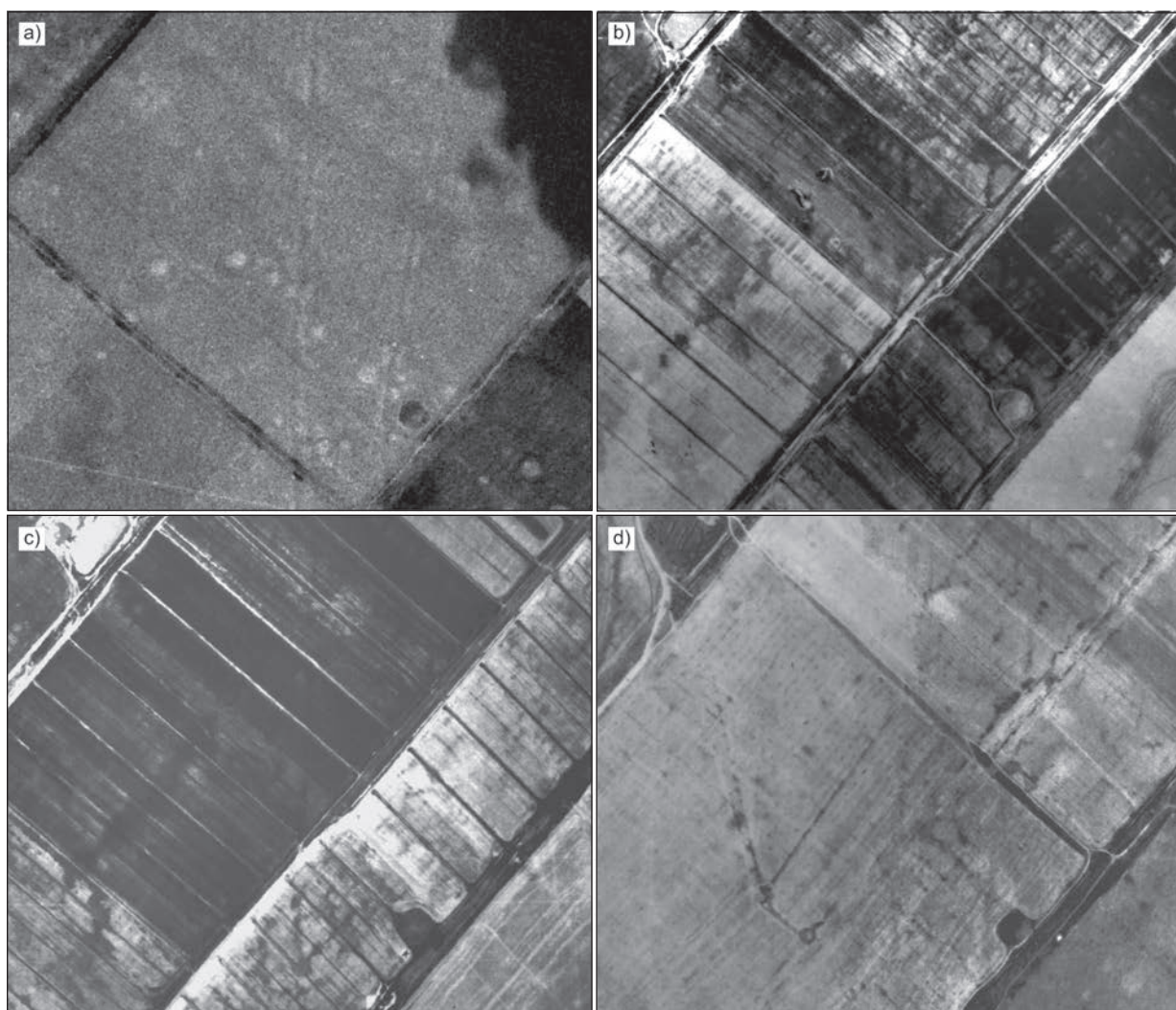

Fig. 3. Fragments of orthophotoplans of different time series. a - satellite photography CORONA KH-4B 1972; b - aerial photography 1980; c - aerial photography 1987; d - aerial photography 2001.

The images have spatial resolution of 6-10 m. The vector layer contains GPS encoded spots acquired as a result of frequent works on the territory of the Stavropol region.

Therefore, the foundation of the GIS in addition to traditional information will include GPS spots that can be used for geo encoding, ortotransformation of RS data acquired through various sensors as well as creation of different models of relief.

Based on the basic layers, supplementary map materials were aligned; aerial and satellite images were orthorectified.

A Digital Elevation Model (DEM) was built and used at the final stage of aerial photo orthorectification. In order to do this, horizontal axis of cartographic data were digitized.

Based on aerial photography of 1980, 1987, 2001 and space photography CORONA KH-4B orthophotomaps were made reflecting area situation at different moments. In addition, images were graphically decoded to identify any presence of archaeological objects. These materials were supplemented with maps of different scales and time periods as well as data acquired during the field research.

For research convenience, the territory of investigation was divided into clusters, squares with sides of 1000 m, within which factors determining preservation of objects were identified:

- relief: gradient of territory, exposition of the slope
- human activities: man-induced processes, farming and construction
- natural negative factors: fall outs, temperature, wind directions, soil erosion

Factor analysis allowed estimating the impact of territorial conditions on preservation of archaeological sites.

For identified objects protection zones of limited human activity were determined. Buffer zones (polygon-shaped in the vector representation) were established for some objects,

RS data collected for a period of over 30 years allowed to estimate the level of preservation of archaeological sites as well as to identify natural and anthropogenic processes that contributed to the destruction of burial mounds. Disastrous impact of anthropogenic activity on archaeological monuments has been revealed. The number of visually detectable kurgan decreased, some have partly disappeared, while many sites were completely destroyed and kurgan moats altered. The entire set of methods resulted in more than 200 previously undetected objects, which found their way to the list of historical sites; their geographic coordinates for GPS system were found.

The resulting "time sections" increased our ability to identify archaeological memorials under destruction, and to work out a set of steps to protect them. Integration of archaeological research, GIS technologies, and remote sensing data (aerial and satellite photography) into a single complex, allowed to rapidly undertake measures aimed at the preservation of historical and cultural heritage in the region. Complex analysis of cartographical and remote sensing data allows including into a preservation list more than 1000 previously undetected objects with data regarding their degree of preservation. GPS technologies allowed undertaking a purposeful search of unknown, visually undetectable monuments, and giving specific recommendations for implementing preservation works for immovable objects.

Aleksey Dovgalev
SUO "Nasledie"
pr. Karl Marks 56, Stavropol, 355006, Russia
nasledie@nasledie.org

LARGE-SCALE MAGNETIC IMAGING AND ELECTRICAL RESISTIVITY TOMOGRAPHY STUDIES IN A ROMAN MILITARY INSTALLATION AREA IN ZEUGMA ARCHAEOLOGICAL SITE, SOUTHEASTERN TURKEY

Mahmut G. Drahor - Özgür T. Kurtulmuş - Meriç A. Berge - Martin Hartmann -Michael A. Speidel

Key words: large-scale, magnetic gradiometer, resistivity inversion, Roman military installation, Zeugma

In antiquity Zeugma was the most important city between the Mesopotamia and Syria, and it was also the main passing point in the Euphrates River. In the Roman Empire, a great military Roman force was garrisoned in the city. Particularly, the *Legio IV Scythica*, which had a great military force, approximately 6000 soldiers. Based on the satellite images the camp of *Legio IV Scythica* was thought to be in the At Meydanı zone lying at the foot of the western slope of Belkis Tepe. The aim of this study was to reveal the Roman military installations found in "At Meydanı" area. Large-scale magnetic gradiometry and resistivity imaging surveys in the At Meydanı zone were conducted in the north, west and east parts of this area between 2002 and 2006.

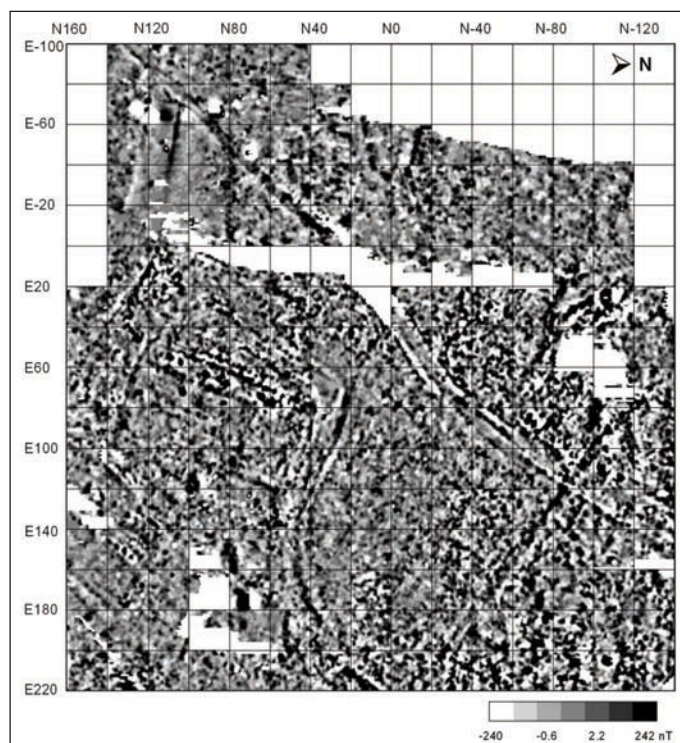

Fig. 1. Large-scale gradiometer image of At Meydanı area in Zeugma, after low-pass filter (3 by 3 window, with Gaussian weighting and brightness and contrast processing).

Large-scale gradiometer survey was carried out over 216 grids, which are 20 x 20 m, with 0.5 m measuring and 1m profile intervals. Data was collected by zigzag measuring technique. Thus, we measured a field with 8.64 ha, approximately. The all data (2002-2003-2005 and 2006) were combined by geoplot software to obtain a more detailed view in the area investigation and were represented in gray-scale image after correction processes (Fig. 1). The image representation showed that magnetic contrast was very good in all of the area. High magnetic anomalies were represented in dark tone, and low magnetic anomalies in light tone in this image. As can be seen from this figure, the general anomaly directions in this area are NW-SE and NE-SW directions and these anomalies are very regular form. As a result, we can conclude that these directions are rather similar to architectural plan of Roman military on the eastern frontier of Roman era. The application of the magnetic gradiometer technique appears to yield promising results for the military installations at Zeugma.

Resistivity data were performed by single channel resistivity instrument that has an apparatus fitting to collect the 2-D multi-electrode data. 2D surveys were continued between 2002 and 2003 survey period. During these surveys, the Wenner type electrode configuration was used along 21 different profiles, oriented N-S or E-W. 2D resistivity data collected in 2002 and 2003 were evaluated by 2D robust inversion technique using Res2dinv software (Geotomo software 2002a). Results were usually obtained after five iterations. Percentage ABS errors did not exceed the value of 2.8% (generally, 1.1%). 3D resistivity surveys were also carried out in 2005 and 2006 using a number of combined 2D data sets in four separate

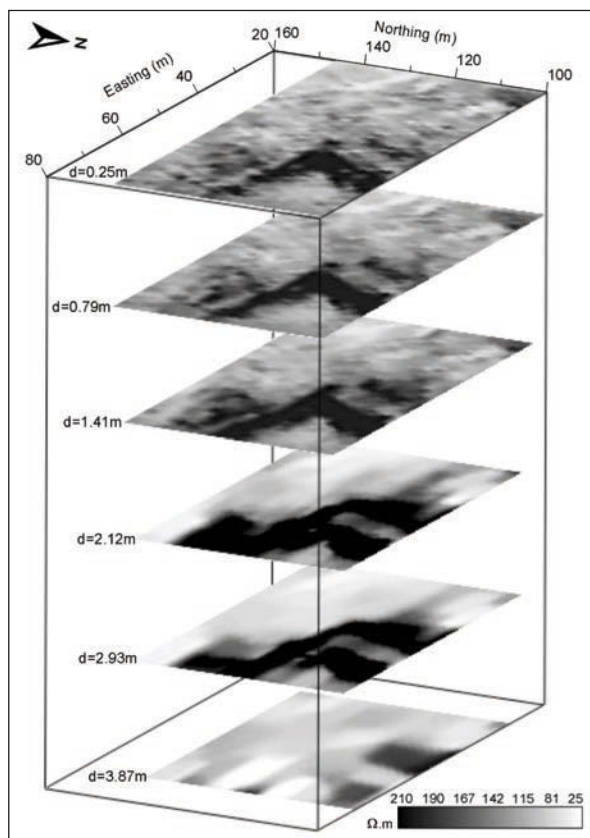

Fig. 2. 3D representation of resistivity inversion images obtained from slices depths of 0.25, 0.79, 1.41, 2.12, 2.93 and 3.87 m in area-III.

areas (I, II, III and IV) found in the western, middle and northern parts of the investigated area, which contains very regular and high magnetic anomalies. During this survey, data was obtained from 26 measuring grids (20x20 m), and an area of 2.04 ha was investigated by electrical imaging technique. The data was also collected using Wenner configuration in array spacing 1, 3, 5 and 7 m along profiles oriented E-W. Measuring and profile intervals were 1 and 2 m, respectively. 3D data prepared from 2D data sets was also processed by the robust inversion algorithm using Res3dinv software (Geotomo software 2002b). The fitting results for 3D resistivity models were achieved after four iterations, and percentage ABS errors did not exceed the value of 2.6% (area-I), 4.9% (area-II), 3.8% (area-III) and 4.3% (area-IV). The resistivity inversion images from area-III are given in Fig. 2. These images were represented as 3D, and their slices depths are 0.25, 0.79, 1.41, 2.12, 2.93 and 3.87 m, respectively. As can be seen from this 3D representation, the archaeological context is clearly observed in the area-III. This result is in compliance with the magnetic imaging results. The resistivity imaging studies were successful in identifying the depths and extents of structures. The resistivity inversion results showed that the structures in general lay at shallow depths, and some of them reached down to lower strata (approx. 4 m depth).

3D volumetric visualisation is a useful tool to present the archaeological context determined by geophysical methods. These visualisations can also be used to produce animations. All inverted resistivity values were combined to process by volumetric representation software. Thus, 3D representations obtained from different angles and depths were displayed by this software. As can be followed from these 3D representations, the extensions of archaeological structures are clearly seen (Fig. 3). Two different 3D volumetric representations of resistivity inversion of area-IV are given in this figure. The top figure represents the 3D visualisation obtained horizontal surface, which is clipped between depth of 0.75 m (Fig. 3a). The ploughing effect was removed by clipped upper surface in the depth of 0.75 m. Thus, the archaeological structures can clearly observe in this figure. In the second representation, top surface was clipped in the depth of 2.0 m. In addition, the southeastern part of this volume was also clipped from depth of 3.8 m. Thus, we performed observing the deeper parts of this area (Fig. 3b). As can be seen from this representation, the deeper archaeological structures settled in the south-western quarter of investigation area can obviously be described.

The archaeological excavation was performed to check the magnetic and resistivity inversion results in 2002 and 2003, and walls and structural bases were discovered. The excavation results verified that magnetic and resistivity imaging surveys were very informative in determining the archaeological structures. Finally, we conclude that resistivity and magnetic imaging provided matching results. This means that each method successfully detected archaeological features in the surveyed area and confirmed the correlation between them. Consequently, the combined usage of these methods allows for a more detailed, less invasive examination of archaeological structures.

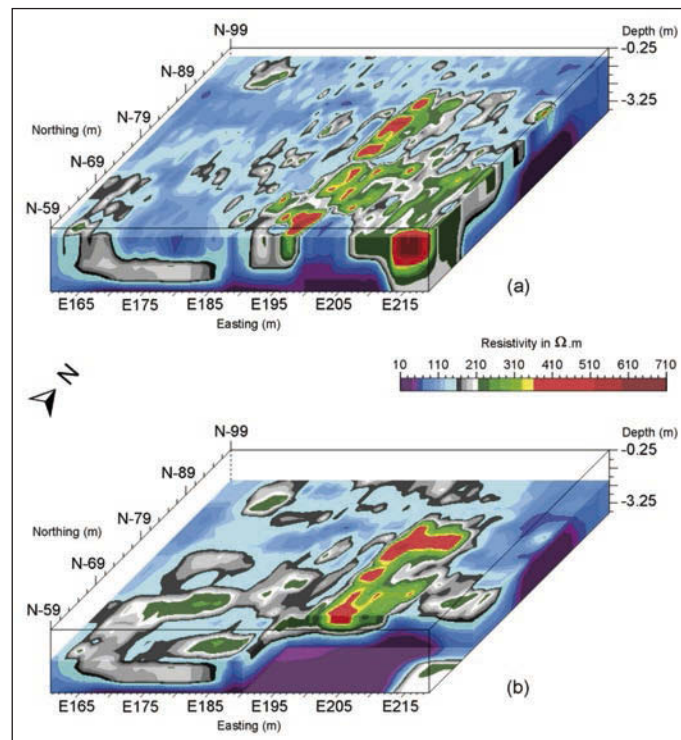

Fig. 3. 3D volumetric representations of resistivity inversion data of area-IV in Zeugma. a - Horizontal surface clipped from the depth of 0.75 m; b - Horizontal surface clipped from the depth of 2 m.

Acknowledgements

This study was supported by Mavors Institute for Ancient Military Studies, Switzerland and Center for Near Surface Geophysics and Archaeological Prospection Center (CNSGAP) of Dokuz Eylül University, Izmir, Turkey. We owe our gratitude to Assoc. Prof. Dr. Kutalmış Görkay, who is a director of Zeugma archaeological excavations and surveys, and his excavation team for the cordial interest and help during the geophysical field surveys.

REFERENCES

Geotomo software 2002a: RES2DINV - Manual, www.geoelectrical.com
Geotomo software 2002b: RES3DINV - Manual, www.geoelectrical.com

Mahmut G. Drahor
Meriç A. Berge
Center For Near Surface Geophysics
and Archaeological Prospection (CNSGAP)
Dokuz Eylül University, Engineering Faculty,
Department of Geophysics
Kaynaklar Campus, 35160 Buca-İzmir, Turkey
goktug.drahor@deu.edu.tr
meric.berge@deu.edu.tr

Özgür T. Kurtulmuş
Center for Near Geophysics
and Archaeological Prospection (CNSGAP)
Dokuz Eylül University
Tınaztepe Campus 35160, Buca-İzmir, Turkey

Michael A. Speidel
Martin Hartmann
Mavors Institute
Lindenberg 23, CH-4058, Basel, Switzerland
speidel@mavors.org
hartmann@mavors.org

MAGNETIC PROSPECTION OF THE RAMPART OF THE EARLY MEDIEVAL HILL-FORT POHANSKO BY BŘECLAV, CZECH REPUBLIC

Petr Dresler - Peter Milo - Vojtech Šešulka

Key words: magnetic prospection, early medieval hill-fort, fortification

Pohansko near Břeclav belonged to the most important centers of the early medieval Great Moravia. It is situated in the Downmoravian valley in a bottomland near the confluence of Dyje and Moravia River in the south-east of the Czech Republic. This is a lowland hill-fort approximately oval shape whose inner part (28 ha) was fortified with two kilometer long defense rampart – fortification. There are adjoining the north forepart of hill-fort fortified by a palisade and apparently non-fortified south forepart (*Macháček 2005*).

Results of geophysical measurement of the perimeter rampart by the south hill-fort edge are considered as an object of this contribution. By archaeologists, there is expected a south gate of this hill-fort in the area of measurement. In addition, this area was chosen on the basis of finds that included burnt materials (daub) on top parts and slopes of this rampart. Geophysical prospection took place at the beginning of the year 2007. 0.22ha were covered by magnetometer survey. The conditions of measurements were obstructed by steep incline of the terrain and also by the fact that the rampart is situated in the forest. Measurement was done by Cs-magnetometer SM-5 Navmag (Scintrex, Kanada), in raster 0,15m/1m.

The measuring was realized along longitudinal as well as transverse profiles. Then these were crossed, thereby space error was eliminated by data collection that was basically inevitable as a consequence of field obstructions. A reference point was located on an axis running approximately on the top of the rampart with the view of data shift minimalization on the transverse profiles to which came by ascent and descent of the rampart. Resulting contour map is so a combination of partial ascents and descents. Several important structures were detected on the magnetograph (Fig. 1). Markedly positive-negative anomaly by the left edge of the area (P) is a consequence of the last archaeological excavation. So there are registered heaps from the archaeological excavation of the removed material near the north edge of the area. Markedly symmetrical anomaly by the upper sector edge is caused by a recent metal (K). In terms of archaeology, a linear structure is interesting (L). This is likely a relic of a rear stake wall of the fortification. A rubble of burnt or fire-through material causes here and there surface extension of positive values in the direct of the hill-fort. On the other side, positive values from the rampart exterior indicate not so magnetically strong material that belongs most likely to the front stone wall and its destruction. These surmises can be very good correlate with a profile gained by archaeological excavation of the rampart in the eastern part of this hill-fort (Fig. 2) The strong

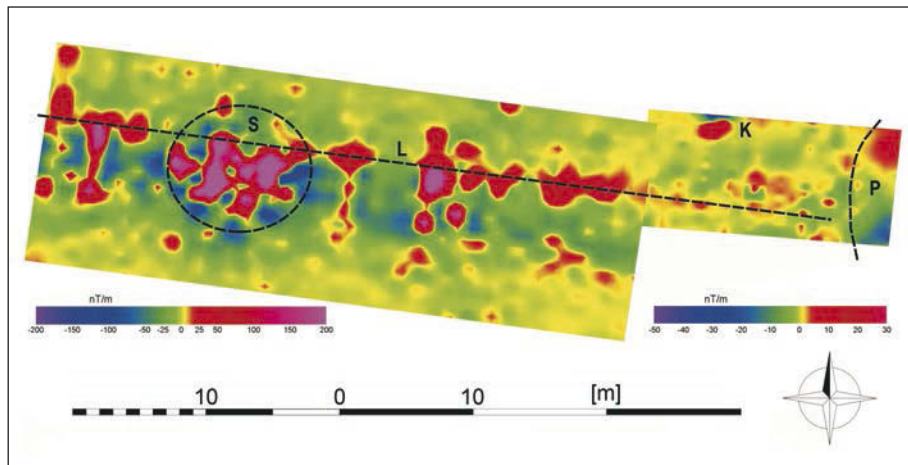

Fig. 1. Pohansko near Břeclav. Magnetometer survey. (L – line structure, probably a relic of a rear wall of the rampart; S – marked anomaly with values >250 nT/m in a space of the surface finds of burnt through materials; K - recent metal; P – remains of archaeological excavation)

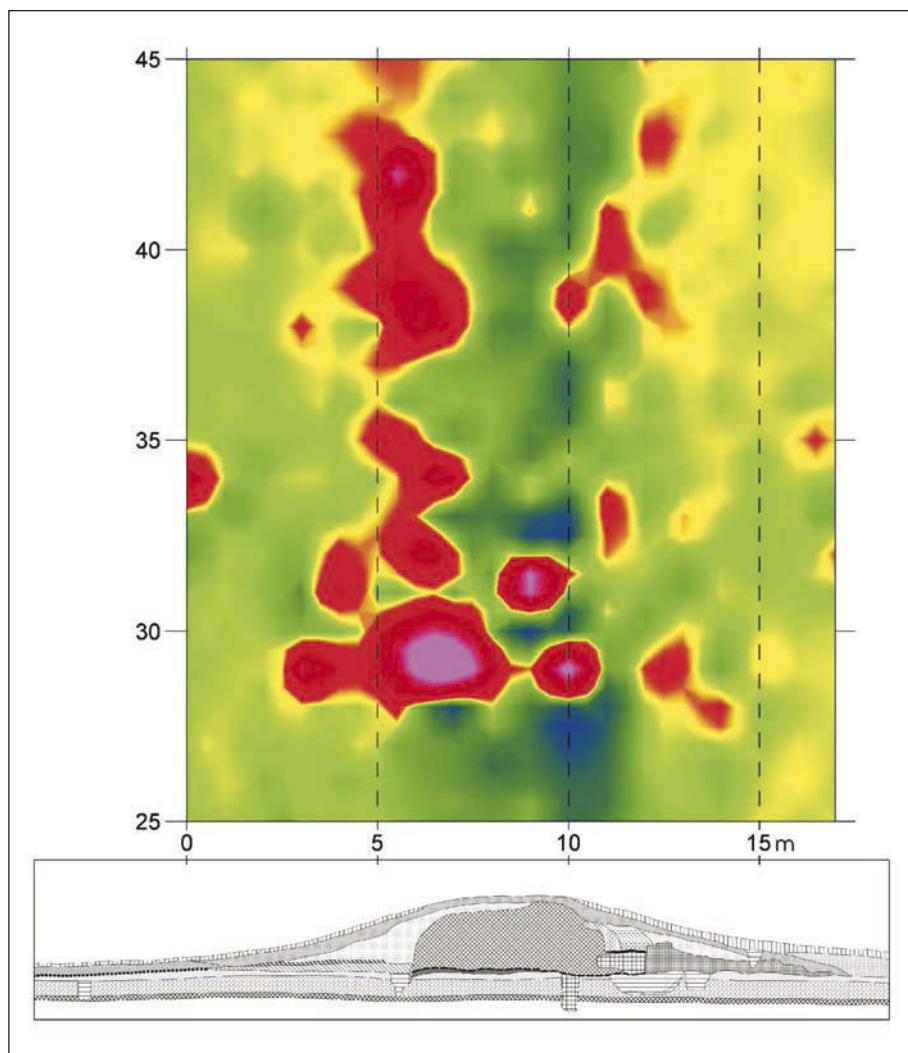

Fig. 2. A cutout from magnetometer in confrontation with a situation in a section No. 18 in eastern part of the rampart.

positive anomalies (S) that achieve the values over 250 nT/m are considered as another significant structure. During an archaeological prospection on this place there were found strong burnt through earth coming to the surface in a large amount. Similar situation was described by a geophysical prospection in an area of the eastern gate in 1979 (Hašek/Měřínský 1991, 123-125). So we can suppose that some bigger structural wood element existed in the space with the strong accumulation of the burnt through earth within the fortification. One of possible interpretations can be an existence of a wooden staircase – a tunnel built in the rampart body. Similar structural element was discovered by archaeological works in another part of hill-fort in 2006.

The results of magnetic prospection in the hill-fort Pohansko near Břeclav prove the sense of non-destructive methods in archaeology. Magnetic prospection enables us to take a view about a situation on an excavated area and to localize places with special constructive elements within a fortification.

REFERENCES

- | | |
|--|--|
| <i>Hašek/Měřínský 1991</i> | V. Hašek/Z. Měřínský: Geofyzikální metody v archeologii na Moravě. Brno 1991. |
| <i>Macháček 2005</i> | J. Macháček: Raně středověké Pohansko u Břeclavi: munitio, palatium, nebo emporium moravských panovníků? Archeologické rozhledy 57, 2005, 100-138. |
| Petr Dresler
Peter Milo
Masarykova univerzita - Filozofická fakulta
Ústav archeologie a muzeologie
Arna Nováka 1, 602 00 Brno, Czech Republic
dresler@phil.muni.cz
milop@post.sk | Vojtech Šešulka
Masarykova univerzita - Přírodovědecká fakulta
Ústav geologických věd
Kotlářská 2, 611 37 Brno, Czech Republic
vsesulka@quick.cz |

USING METHODS OF PALAEOGEOGRAPHY IN FIELD ARCHAEOLOGICAL PROSPECTING

Olga Druzhinina - Ivan Skhodnov

Key words: *palaogeography, Palaeolithic - Mesolithic sites, prognosis*

The paper deals with the problem of using methods of palaogeography for optimization of the field archaeological prospecting. Archaeological monuments of Stone Age, especially of the Palaeolithic and Mesolithic, are in a great degree rare ones. They seem to be of a great value because they provide unique information on the earliest stages of the development of human society. As a consequence of historical causes the data about socioeconomic process in the Palaeolithic – Mesolithic on the territory of Kaliningrad region are fewer than those about neighboring territories of northern Poland and south-western Lithuania. To optimize the archaeological researches, especially prospecting, some methods of palaogeography are applied on the preliminary stage of the studies. They include different kinds of palaogeographical reconstructions and maps based on them. The latter reflect the geomorphologic, climate, landscape situation for each of periods of final Pleistocene and early Holocene. The retrospective analysis permits to defend territories with the most convenient natural characteristics and therefore settled by the ancient people in the first turn. The factors that contributed to colonization were parameters of mesorelief (river terraces, dunes), water resources (river and lake net), location of raw-material sources, character of substratum (sandy, gravel). This approach allows to make prognosis and to share out areas which are the most perspective for field prospecting. We assume that the river Sheshupe valley is that kind of territory.

During the field season of 2006, the terraces in the lower course of the river Sheshupe were investigated. The palaogeographical reconstructions show that after the recession of the ice sheet in the Dryas I Period the barrier lake appeared here. It existed about 300 years and then its waters came down with the appearance of the Neman and the Sheshupe rivers. The palaogeographical data justify the surmise that from the Bölling Period the environmental conditions in the lower course of the river Sheshupe were rather favourable, or at least did not hamper human settlement there. The investigated area combined several factors that could attract the first inhabitants to the valley landscapes, such as sand and sandy-gravel substratum of the terraces and flint resources. During the prospecting on

the partly preserved second “high” terrace two sites dated to final Palaeolithic – early Mesolithic were found. The research continues in the zones where we expect to find new archaeological sites.

Olga Druzhinina
 Ivan Skhodnov
 Immanuel Kant State University of Russia
 Faculty of Geography and Geoecology
 ul. Universitetskaja, d. 2, Kaliningrad 236041, Russia
 druzh78@mail.ru
 skhodnov@mail.ru

LOCALIZATION OF RING STRUCTURES IN EARTH ENVIRONMENTS

Lev V. Eppelbaum

Key words: ring structures, potential field analysis, modeling

Introduction

Ring structures (RS) phenomenon is widely presented in earth environments (Fig. 1). RS may generally be classified as Terrestrial, Extraterrestrial and Archaeological. It should be noted that regardless of the popular opinion, the dimension of Terrestrial and Extraterrestrial RS is often compatible with the size of Archaeological RS (now we do not refer to the well-studied RS of tens and hundreds kms in diameter). Therefore, the problem that sometimes arises is not only of RS identification, but also of its correct classification. Effectiveness of such classification is increasing with all available geological (geochemical), geophysical and archaeological information. In the developed block-scheme (Fig. 1), Archaeological RS are presented as buried caves, pavements and circus rings, fortress remains and towers, tailings of vital functions and spiritual constructions. Obviously, the number of types of archaeological RS may be significantly extended.

Methodology of RS delineation

The first problem that arises when studying RS, is its revealing (delineation) against the background noises. Very frequently it is difficult to single out RS in complex geological-geophysical environment, especially when taking

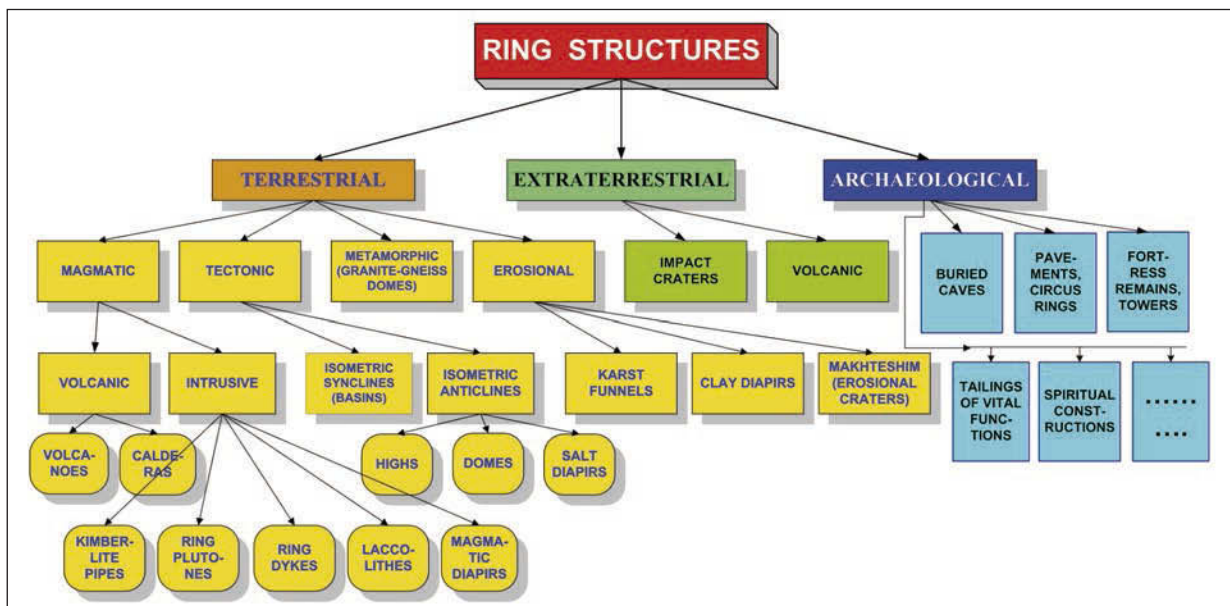

Fig. 1. Classification of ring structures in earth environments (after Eppelbaum et al., 1998, revised and supplemented).

into account the commonly employed rectangular network of geophysical observations. Besides, one has to discriminate between the anomalies caused by RS and the features of the field stemming from its character on the periphery of stock-like bodies. For this purpose a special method was developed for distinguishing concentric structures, which is based on summing up horizontal gradients of geophysical field using a circular “apparent” graticule (this term means that in practice its program realization is applied; *Khesin et al. 1996*).

The apparent graticule radii drawn with the interval of 45° determine horizontal gradients (Fig. 2C). When summing up the gradients in various directions, the presence of circular features should be intensified, whereas other signals are leveled. Here the correlation of the sum of gradients (or the average gradient) for a circle with the radius R_n and a ring external to this circle limited by R_n and R_{n+1} radii makes it possible to determine whether the circular feature revealed reflects the centric or the ring structure (Fig. 2D). The sum of gradients inside the circle tends to zero in the absence of a centric texture (*Khesin et al. 1996*). Application of this method is explained on the model of the inclined circular cylinder magnetized along its dip (Fig. 2A, B).

A unified approach to potential and quasi-potential field analysis

The modern interpreting system developed for magnetic field analysis (*Khesin et al. 1996; Eppelbaum et al. 2001*) includes the following components (besides conventional ones): 1 - Elimination of the secondary effect of time variations, 2 - Calculation of terrain relief influence and estimation of magnetization of the medium, 3 - Application

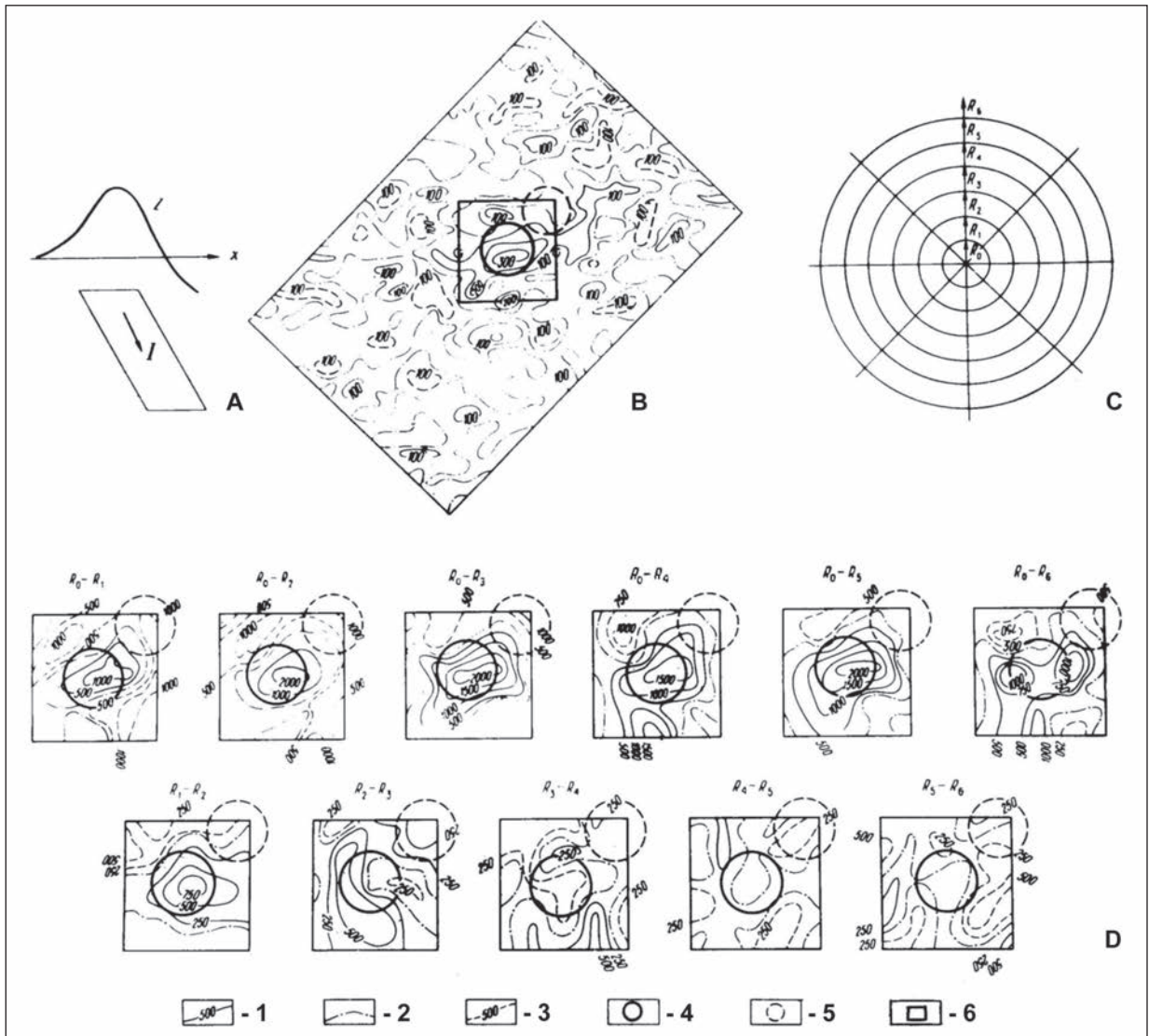

Fig. 2. Singling out a ring structure. a - model field of inclined circular cylinder calculated along a profile; b - model field complicated by random noise; c - apparent graticule for ring structure revealing; d - singling out a model body by summing up horizontal gradients of field within the apparent circular graticule zones. Isolines of a model field (b) and the sum of its gradients (d): (1) positive, (2) zero, (3) negative; cylinder edge projection: (4) upper, (5) lower; (6) contour of the portion treated on the (b) (after *Khesin et al., 1996*).

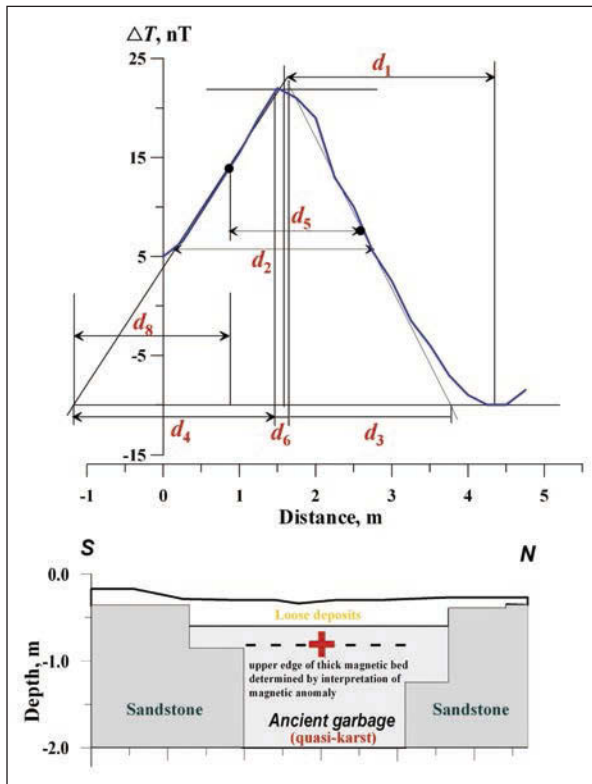

Fig. 3. Interpretation of magnetic anomaly due to ancient garbage RS on the site of Ashqelon-Marina (southern Israel, after Eppelbaum et al. 2001, with modifications).

positive anomalies of 12–20 nT (Eppelbaum et al. 2001). Fig. 3 shows an example of magnetic anomaly interpretation (improved methods of tangents, characteristic point and areal were applied) over one of such ancient garbage pits (quasi-karst terrane) (disturbing body was here approximated by a thick bed model).

of information approach to geophysical field qualitative interpretation, 4 - Inverse problem solution for complicated environments (inclined relief, oblique magnetization and unknown level of the normal magnetic field; anomalous bodies are approximated by models of thin inclined bed, thick inclined bed and horizontal circular cylinder), 5 - 3-D combined modeling of magnetic and gravity fields. At the last 6 - stage all the information obtained at the abovementioned stages as well as by the use of conventional studies, is integrated, and a final physical-geological (physical-archaeological) RS model is developed.

It was proved (Eppelbaum 1991; Eppelbaum and Khesin 1992; Khesin et al. 1993; Alexeyev et al. 1996; Eppelbaum et al. 1996; Khesin et al. 1996, 1997; Eppelbaum 1999; Eppelbaum and Khesin 2002; Eppelbaum et al. 2006) that procedures enumerated in items (1-4) (especially (4)) may be effectively adapted in other geophysical methods: gravity, thermal, self-potential, DC, VLF and induced polarization.

Example of magnetic field quantitative analysis of RS

The archaeological site Ashqelon-Marina is located on the southern coastal plain of Israel, near the Ashqelon town. The ancient pits (indicative material may be dated to the Early Bronze period (Golani 2000)) were all found full of refuse (pottery, flints, bones, stone vessel fragments, some botanical remains and shells). The overlying layer of dark brown sandy soil was found to be over half a meter in thickness. These features were displayed in the magnetic map as ring (R1.5-2m)

REFERENCES

- Alexeyev/Khesin/Eppelbaum 1996 V. V. Alexeyev/B. E. Khesin/L. V. Eppelbaum: Geophysical fields observed at different heights: A common interpretation technique. *Proceed. of the Meeting of Soc. of Explor. Geophys.*, Jakarta, 1996, 104-108.
- Eppelbaum 1991 L. V. Eppelbaum: Examples of terrain corrections in the VLF-method in the Caucasian region, USSR. *Geoexploration* 28, 1991, 67-75.
- Eppelbaum 1999 L. V. Eppelbaum: Quantitative interpretation of resistivity anomalies using advanced methods developed in magnetic prospecting. *Trans. of the XXIV General Assembly of the Europ. Geoph. Soc. Strasbourg* 1, 1991, 166.
- Eppelbaum/Khesin 1992 L. V. Eppelbaum/B. E. Khesin: VLF-method: elimination of noises and quantitative interpretation. *Coll. of selected Papers. Symp. on Electromagnetic Compatibility "1992 - From a Unified Region to a Unified World"*, Section "LF to ULF" Electromagnetics and the Earth, 5.2.1, Tel Aviv, 1992, 1-6.
- Eppelbaum/Modelevsky/Pilchin 1996 L. V. Eppelbaum/M. M. Modelevsky/A. N. Pilchin: Thermal investigation in petroleum geology: the experience of implication in the Dead Sea Rift zone, Israel. *Journal of Petroleum Geology* 19, No. 4, 1996, 425-444.
- Eppelbaum/Livshits/Flexer/Ben-Avraham 1998 L. V. Eppelbaum/Ya. Livshits/A. Flexer/Z. Ben-Avraham: Integrated geological-geophysical analysis of Ring Structures phenomenon in the Eastern Mediterranean. *Trans. of the Conf. of Israel Geological Society. Ann. Meet., Mizpe-Ramon, Israel*, 1998, 25.
- Eppelbaum/Khesin/Itkis 2001 L. V. Eppelbaum/B. E. Khesin/S. E. Itkis: Prompt magnetic investigations of archaeological remains in areas of infrastructure development: Israeli experience. *Archaeological Prospection* 8, 2001, 163-185.

- Eppelbaum/Khesin/Itkis 2006* L. V. Eppelbaum/B. E. Khesin/S. E. Itkis: Some peculiarities of geophysical investigations at archaeological sites in Israel. *Russian Archaeology*, 2006, 59-70.
- Golani 2000* A. Golani: Salvage Excavation at the Early Bronze Age Site at Ashqelon Afridar Area E. Israel Antiquities Authority, Jerusalem 2000.
- Khesin/Alexeyev/Eppelbaum 1993* B. E. Khesin/V. V. Alexeyev/L. V. Eppelbaum: Investigation of geophysical fields in pyrite deposits under mountainous conditions. *Journal of Applied Geophysics* 31, 1993, 187-205.
- Khesin/Eppelbaum 1994* B. E. Khesin/L. V. Eppelbaum: Near-surface thermal prospecting: Review of processing and interpretation. *Geophysics* 59, 1994, 744-752.
- Khesin/Alexeyev/Eppelbaum 1996* B. E. Khesin/V. V. Alexeyev/L. V. Eppelbaum: Interpretation of Geophysical Fields in Complicated Environments. Ser.: *Advanced Approaches in Geophysics* 1996, 362.
- Khesin/Alexeyev/Eppelbaum 1997* B. E. Khesin/V. V. Alexeyev/L. V. Eppelbaum: Rapid methods for interpretation of induced polarization anomalies. *Journal of Applied Geophysics* 37, 1997, 117-130.

Lev V. Eppelbaum
Dept. of Geophysics and Planetary Sciences,
Raymond and Beverly Sackler Faculty of Exact Sciences
Tel Aviv University
Ramat Aviv 69978, Tel Aviv, Israel
levap@post.tau.ac.il
leppelbaum@gmail.com

EASTER ISLAND (CHILE): MAGNETOMETRY OF ARCHAEOLOGICAL STRUCTURES ON BASALTIC GEOLOGY

Jorg W. E. Fassbinder - Karin Berghausen - Burkhard Vogt - Johannes Moser

Key words: Easter Island, Moais, magnetometry, ceremonial structures, basaltic geology

Introduction

As a joint project of the Bavarian State Dept. of Monuments and Sites, under the direction of the German Archaeological Institute and Chilean Consejo de Monumentos Nacionales, a geophysical survey was undertaken to test the suitability of geophysical prospecting on archaeological sites of the Easter Island.

In general it is a widely held belief that the search for archaeological structures by magnetometry on volcanic soils and/or basaltic geology is utterly impossible because of the strong magnetic background of the geological structures. Therefore the geophysical aim of the project was primarily to make tests with the geophysical instruments in order to find a suitable prospecting method for future work.

Archaeological background

The Easter Island, located 27°09' S and 109°27' W, named in the native language as Rapa Nui or Isla de Pascua in Spanish, is an island in the South Pacific Ocean, situated on the volcanic area of the East Pacific Ridge. Roughly 3900 kms west of continental Chile and ca 2,000 kms east of Pitcairn Island, it is one of the most isolated inhabited islands in the world, nowadays occupied by nearly 3500 people. It was given its common name of "Easter" because it was discovered by the Dutch navigator Jacob Roggeveen on the Easter Sunday on April 5th 1722. The island is made up of volcanoes, and therefore has a basaltic geology. Remarkable from the archaeological point of view are the numerous and large stone statues, called Moai, for which Easter Island is world famous. Most of them are located along the coastlines on stone platforms named Ahu. They were carved during a relatively short and intense burst of creative and productive megalithic activity.

There is considerable uncertainty about the accuracy of the date of settlement. Published dates range from AD 300 to 1200. They are based on glottochronological calculations and on three radiocarbon dates from charcoal, which seem to have been produced during forest clearance activities. A recent study, including radiocarbon dates from what is thought to be very early material, indicates that the island was settled as late as AD 1200, the time of the deforestation of the island. The Norwegian ethnographer Thor Heyerdahl pointed out many cultural similarities



Fig. 1. Ahu Akivi. One of the authors prospecting in front of the Ahu Akivi site with the optical pumped caesium magnetometer.

between Easter Island and the pre-Columbian cultures of South America, which he suggested might have resulted from some settlers arriving from the continent. But also the origin of the inhabitants is still under debate. The disappearance of the island's trees seems to coincide with a decline of the Easter Island civilization around the 17th-18th century AD. Given the island's southern latitude, the climatic effects of the Little Ice Age (1650-1850) may also have contributed to the deforestation of the island and the collapse of the ancient Rapa Nui culture.

Magnetic susceptibility

Measurements of magnetic susceptibility were done with the Kappa meter SM30 (Zh-Instruments, Czech Republic). This is a suitable instrument to measure the amount and the difference in the content of magnetic minerals in soil and rocks in situ. The results were surprising. Although the basalts have the usual high content in magnetic minerals, the susceptibility of the topsoil reveals a fourfold value. The effect is that we have enhancement of magnetic minerals in the top soil as they were usually found in Europe, but with 100 fold intensities of the magnetic anomalies.

Tab. 1. Magnetic susceptibility of typical soil and rocks which are common on the island.

soil/rock	magnetic susceptibility $\times 10^{-3}$ SI units
top soil	19-24
sub soil (yellow)	10,1-15,3
sub soil (red)	5,8-18,7
volcanic (white ash layers)	10,0-13,1
basalt black (most widespread)	4-6
red tuff (hat of the Moai)	0,20-0,30
yellow tuff (Moai, Ranu Raku)	1,8-2,4
white sand (Anakena beach)	0,4-0,46

Magnetometry

The results of the magnetic susceptibility reveal quite reasonable values to encourage us to use the total field magnetometer (Scintrex SM4G special, Canada) in the second stage. The total Earth's magnetic field on the Isla de Pascua was ca. 34.000 Nanotesla.

For the first tests of magnetometry we selected three archaeological sites in front of the Ahus, because on most of these sites there is a large flat area, which is covered by grass. No archaeological structures are visible from the surface on these selected sites.

- 1) In front of the Moai of the Ahu Akivi (120x80 m in size)
- 2) In front of the Moai at the Honga Te'e (80x80 m in size)
- 3) Part of the area in front of the Ahu Tahai (80x40 m in size)

The first measured area was the Ahu Akivi site, which is well known because it is one of the rare sites, where the Moai's are facing the ocean.

The results of Ahu Akivi site were unexpected. Concentric to and symmetrically to the stone platform we detected ring shaped structures. Tangential to these structures two linear structures are visible. All these structures are cut or overlain by other linear structures, which are oriented rectangular to the Ahu.

The magnetic remanence vector of the archaeological structures has the same direction as the induced magnetization vector; therefore we suppose that these linear structures are due to a ditch refilled by highly magnetic topsoil

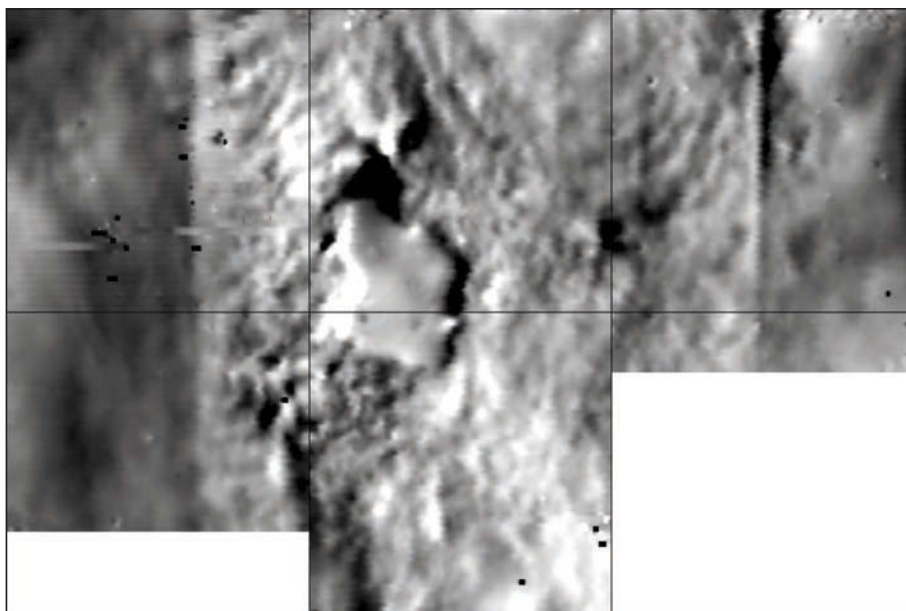

Fig. 2. Magnetogramm of the Ahu Akivi site. Smartmag SM4G special in an uncompensated duo-sensor configuration, total Earth's magnetic field ca. 34.000 Nanotesla, dynamics +/- 800 Nanotesla, in 256 grey values from black to white, grid size 40x40 meter, sampling rate interpolated to 25x25 cm. (Notice the high intensities of the magnetic anomalies).

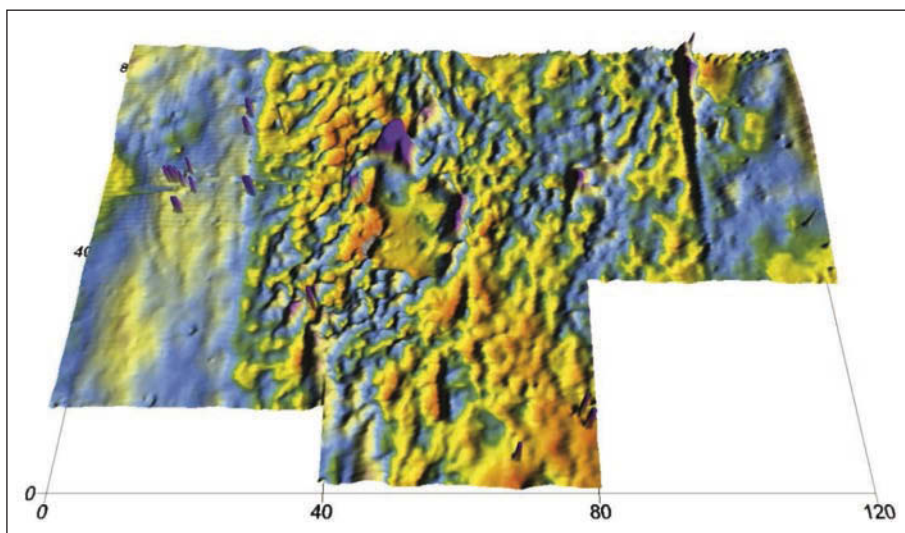

Fig. 3. 3D view of the magnetic data of the Ahu Akivi site. Smartmag SM4G special in duo-sensor configuration, total Earth's magnetic field ca. 34.000 Nanotesla, dynamics +/- 500 Nanotesla, in colour display 40x40 meter, sampling rate interpolated to 25x25 cm.

rather than to basaltic rocks. We suggest that these structures are due to the arrangement of a ceremonial area in front of the Ahus. Moreover we were able to detect also a stratigraphy of the site, and we suppose that the area was modified several times and therefore used by the ancients for a longer time.

Conclusion

The results show that we are able to trace archaeological structures beneath the ground although we were prospecting on basaltic geology. All these archaeological researches and results were done without touching the ground and without destruction or excavation of the monument. The method is thus an excellent tool to recover and to understand further archaeological details and the history of these extraordinary monuments. It will help archaeologists to reduce excavation to small size or trenches, which will help to preserve the archaeological sites.

REFERENCES

- Diamond 2005* J. Diamond: Collapse How Societies chose to fail or succeed. Chapter 2: Twilight at Easter 2005, 79-119.
Heyderdahl 1989 T. Heyderdahl: Easter Island - The Mystery Solved. Random House New York 1989.
Hunt/Lipo 2006 T. L. Hunt/C. P. Lipo: Late Colonization of Easter Island Science, 1121879. URL.

Jörg W. E. Fassbinder
Karin Berghausen
Bavarian State Dept. of Monuments and Sites
Archaeological Prospection
Postfach 100203 D-80076 Munich, Germany
joerg.fassbinder@blfd.bayern.de
karin.berghausen@blfd.bayern.de

Burkhard Vogt
Johannes Moser
KAAK, Deutsches Archaeologisches Institut
Endenicher Str. 41, 53115 Bonn, Germany
vogt@kaak.dainst.de

MAGNETOMETRY ON NEWLY DISCOVERED BRONZE AGE SETTLEMENTS IN THE NORTH CAUCASUS (RUSSIA)

**Jörg W. E. Fassbinder - Dmitry Korobov - Sabine Reinhold -
Andrej Belinskiy - Sergej Merkulov**

Key words: Bronze Age, magnetic prospection, GIS, settlement, Caucasus, Russia

In 2004, Dmitry Korobov and Sabine Reinhold discovered Bronze Age settlements of a so far unknown type. The major characteristic of these sites is a symmetric layout around a large central place. On an area of about 30 km² more than 55 sites are situated on a plateau in the North Caucasian piedmonts, south of the town Kislovodsk. Analysis of satellite images, aerial photos and topographical survey combined with intensive field survey and small scaled excavations allowed already to present detailed maps of these settlements. Here we report on the results of the large-area geophysical prospecting of three of these settlements. The combined interpretation of aerial photographs, satellite images and topographical maps and geophysical data provide detailed information on the structure; the excavation gave the dating of the settlement.

Archaeology

The characteristic trait of the newly discovered settlements is a central oval place, around which rows of up to 35 buildings are attached. Most of these sites have a symmetrical layout with bear resemblance to the shape of a horseshoe. There are, however, others in form of large rows of houses. The configuration of the buildings forms small villages of roughly one hectare in size. The architecture is of stone, so that their ruins are still on the surface and on the remote sensing data. They occur in a zone between the foreland and the high mountains of the Elbrus massif around the city of Kislovodsk. So far 55 sites of this type are arranged from the Pokunsyt to Kabardinka mountain ranges and are located on the plateau edges which decline to the north. The sites are in an altitude of 1400-2400 meters above sea level and

therefore far beyond the zone of agriculture today. Grazing land is used only up to an altitude of 1800 m. Therefore we do not talk of a few individual settlements but of a whole cultural landscape with a certain mode of subsistence.

Magnetometry

Concurrently with the analysis of aerial photographs and to the topographical work on the site we carried out a large area magnetometer survey. For prospecting we used the Cesium Smartmag SM 4 magnetometer in a total field configuration in order to obtain also information on the sub soil and the geological underground. As an example we picked out the settlements Kabardinka 2 to 5. On the site Kabardinka 2 only about 120x100 m in size was visible from the air and topographical survey. We extended the grid to 300x240 m to obtain also information on possible, but yet undetected structures.

The magnetometer data revealed further archaeological details of the inner structure of the houses. Inside of some of the houses we detect fireplaces but no traces of pottery kilns. Some other houses were detected by their negative anomaly from the fundaments made by limestone.

The topographically visible structures of the buildings, (nonmagnetic limestone) show up as negative magnetic anomalies in the adjacent soil. These structures are slightly diffuse due to the fact that the stone debris from the walls covers the groundwork of the houses. The interior of these two rowed houses, which faces the inner central place, reveals higher magnetic anomalies than the other rooms of the building. This is due to a higher activity and the use of hearths and fireplaces, or it is due to ceramic or organic material. (Remarkable is a thin line of high magnetic anomalies just on the fringes of the walls, which borders the central place, and showed up as wall debris when excavated. Here in the so far excavated areas the highest density of ceramics was noticeable).

The results reveal also details on the environment of the settlement. Some of the topographically visible burial mounds have stone chambers and others do not. Moreover, some yet unknown burials were detected by magnetometry. South of the biggest burial mound we suggest the occurrence of roughly 15 urn-graves. In archaeological knowledge, urn-graves, however, are generally unknown from this area.

An additional outcome of the magnetometer survey, which was only detectable by the uncompensated duo sensor configuration of the Bavarian magnetometer system, was the discovery of a ring shaped zone of highly magnetic material outside the settlements. This material, which consists of highly magnetic material like midden, is found in the ca 30-meter broad zone around the whole settlement. The zone obviously refers to the arrangement of the whole settlement and was detected on the other settlement sites as well. Important for the interpretation was also the fact that this zone is correlating with an area where, during archaeological survey, also a high concentration of pottery findings was located. Whether this is due only to debris or whether it is the trace of seasonal settlement aligned parallel to the stone houses can be clarified only by archaeological excavation.

Conclusion

A combination of the magnetometer finding with a selective archaeological excavation will yield further evidence on the dating but moreover it will also explain the utilization of the settlement in detail, e.g. if the building was used for living, for fireplaces or as a stable, not only for a single building but for the settlement as a whole.

Magnetometry is a suitable archaeological method, both to find and to trace previously unseen structures beneath the large area of settlements, as it avoids destruction and excavation in favour of the combination of geophysical interpretation of magnetometer data with archaeological finding. It thus contributes effectively to the understanding of large archaeological sites.



Fig. 1. View of the surveyed site. In the background the Elbrus massif with an altitude of 5600 meters, the highest mountain of Europe.

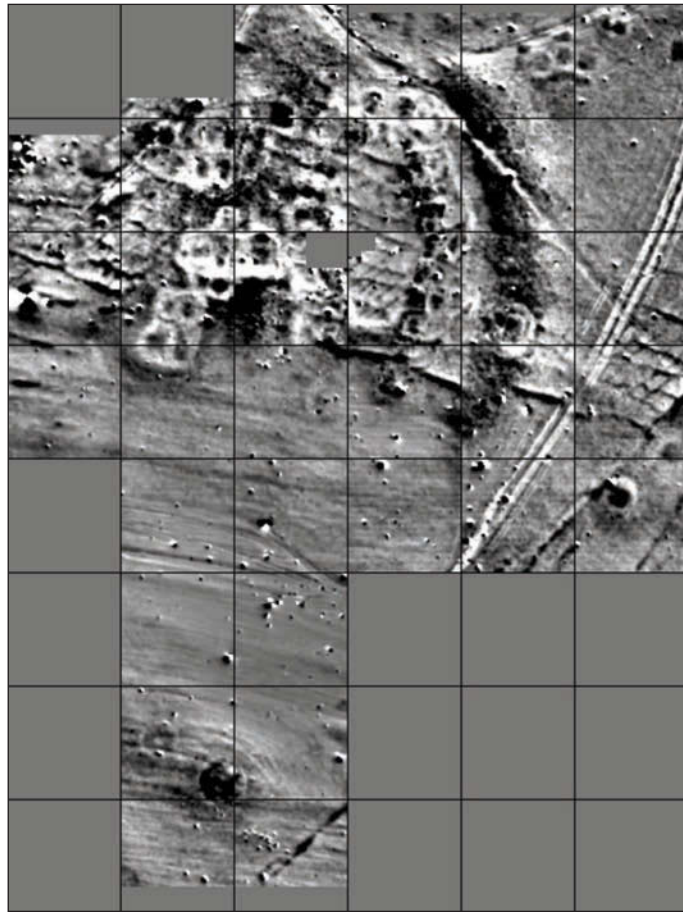

Fig. 2. Magnetogramm of the Kabardinka 2. Smartmag SM4G special in duo-sensor configuration, total Earth's magnetic field ca. 49.450 Nanotesla, dynamics +/-13,00 Nanotesla in 256 grey values from black to white, grid size 40x40 meter, sampling density interpolated to 25x25 cm.

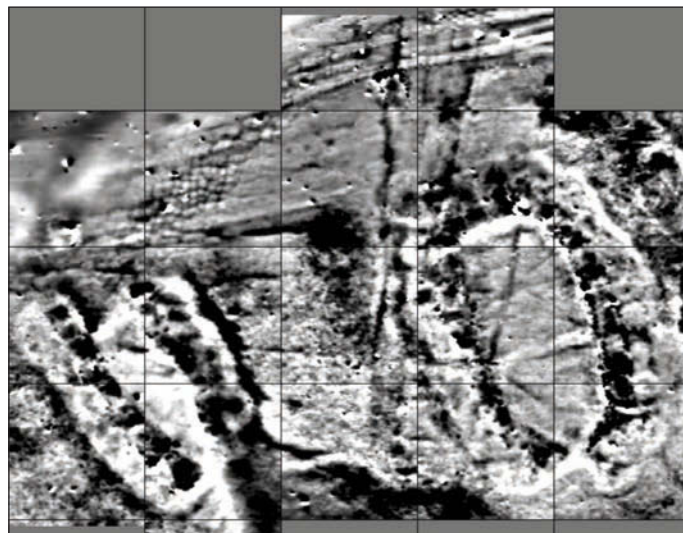

Fig. 3. Magnetogramm of the Kabardinka 3 and 4. Smartmag SM4G special in duo-sensor configuration, total Earth's magnetic field ca. 49.450 Nanotesla, dynamics +/-13,00 Nanotesla in 256 grey values from black to white, grid size 40x40 m, sampling density interpolated to 25x25 cm.

REFERENCES

- Fassbinder/Reinhold/Korobov 2007* J. W. E. Fassbinder/S. Reinhold/D. Korobov: Magnetometrie auf neu entdeckten früh-eisenzeitlichen Siedlungslandschaften bei Kislovodsk im Nordkaukasus. Denkmalpflege Informationen, 136, 2007, 58-59.
- Korobov 2001* D. Korobov: Archaeological prospection in the Kislovodsk basin (South of Russia): GIS and aerial photography. In: M. Doneus, A. Eder-Hinterleitner, W. Neubauer (eds), Archaeological prospection. Fourth International Conference on Archaeological Prospection. Vienna 2001, 133-135.
- Merkulov/Reinhold 2006* S. Merkulov/S. Reinhold: First results of GPR soundings on Late Bronze/Early Iron Age settlements with stone-architecture in the North Caucasus. In: Archeologija i geoinformatika 3. CD-Publikation, Moskau 2006.
- Reinhold/Korobov 2005* S. Reinhold/D. Korobov: Aerial photography and field survey - a new type of late Bronze Age settlements in the North Caucasus discovered from the air. 6th International Conference on Archaeological Prospection, Rome 2005, 104-107.

Jörg W. E. Fassbinder
Bavarian State Dept. of Monuments and Sites
Archaeological Prospection
Postfach 100203 D-80076 Munich, Germany
joerg.fassbinder@blfd.bayern.de

Sergej Merkulov
Andrej Belinskiy
Unitary Government Enterprise Naslediyе
Stavropol Krai, Stavropol, Russia
nasledie@nasledie.org

Dmitry Korobov
Institute of Archaeology RAS
117036 Dm. Uljanova str., 19, Moscow, Russia
dkorobov@mail.ru

Sabine Reinhold
Deutsches Archäologisches Institut Eurasien Abteilung
Im Dol 6. D-14195 Berlin, Germany
sabine_reinhold@hotmail.com

SURVEYING ANCIENT CITIES IN THE NILE DELTA: THE TELL EL-DAB^cA CASE

Irene Forstner-Müller - Tomasz Herbich - Christian Schweitzer

Keywords: *Ancient Egypt, Nile Delta, magnetic prospection*

Tell el-Dab^ca is located in the eastern part of the Nile Delta, Egypt. Known to Egyptologists since 1885 thanks to E. Naville's excavation, the site was later investigated by *M. Hamza* (1928), *L. Habaschi* (1941-42), *Sh. Adam* (1951-54) and the Austrian Archaeological Institute in Cairo, under the direction of *M. Bietak* (1966-69 and from 1975 onwards).

The site can be identified with *Avaris*, capital of the *Hyksos* (15th Dynasty, 1640-1532 BC) and with the southern part of *Piramesse*, the Delta residence of *Ramesses II* (1290-1224 BC) and his successors. Most probably this place was also identical with the biblical town *Raamses/Ramesse* from the time of the *Ramessides* (19th and 20th Dynasties, 1307-1070 BC) (*Bietak and Forstner-Müller* in print).

The town was founded on now buried sand mounds (*geziras*) on the southeastern bank of the ancient Pelusiac branch of Nile. The *geziras* were preferred for settlement for they remained unflooded during annual Nile inundations. At present the whole area is cultivated and remains of ancient settlement mounds survive in only a few places. From 1985 to 1990 the ancient landscape of Tell el-Dab^ca/Qantir was reconstructed over an area of 12 km² based on 900 core drillings (*Dorner 1994*). His map of the reconstructed historical landscape with the old Pelusiac branch, the river system and turtlebacks set the framework for all prospective work in Tell el-Dab^ca.

The oldest settlement of which there is evidence, founded by the early 12th Dynasty, was probably of modest size. Towards the end of the 12th Dynasty the settlement expanded to the south and covered c. 75 ha. During the Second Intermediate Period, the reign of the *Hyksos* (1640-1532 BC), the settlement attained a size of appor. 250 ha and became one of the largest towns of Egypt. Consequently, classical archaeological methods like excavation were of no use for the reconstruction of the urban plan, necessitating the use of other surveying methods. The survey carried out by *H. Becker* and *J. Fassbinder* in neighbouring Qantir showed the efficiency of the magnetometer prospection method applied to this kind of research (*Pusch et al. 2000*).

In 1999, T. Herbich began a magnetic survey of Tell el-Dab^{ca}. Measurements were taken in parallel mode in a grid 0.50 by 0.25 m with a fluxgate gradiometer Geoscan Research FM36 (*Herbich 2001*). The readings fell in the range of +/- 10 nT and after several days of work there was no doubt that the method would be just useful as it had turned out in Qantir. The survey, carried out at 'Ezbet Helmi in the northwestern part of the old town of Avaris, revealed remains of the Tuthmoside palatial platform (palace G), remains of the Hyksos citadel ramparts (section of buttressed wall) and remains of town architecture with houses demonstrating a typical New Kingdom layout (*Bietak et al. 2001; Herbich 2003*).

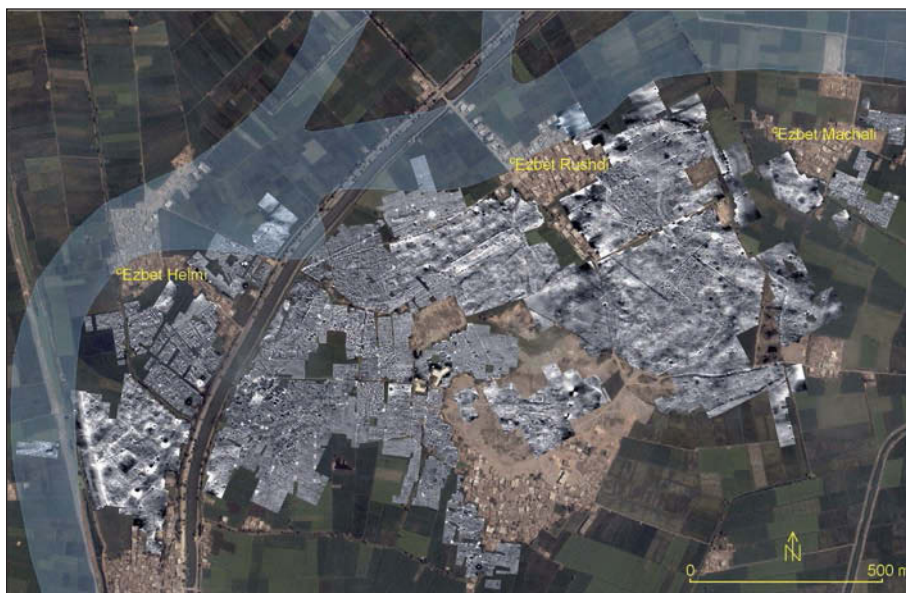

Fig. 1. Magnetic map superimposed on a satellite image (Google Earth). Reconstruction of the course of the Pelusiac branch of the Nile in transparent blue. Geoscan Research fluxgate magnetometer FM18/FM36/FM256 and caesium Scintrex Smartmag SM-4/4G-special.

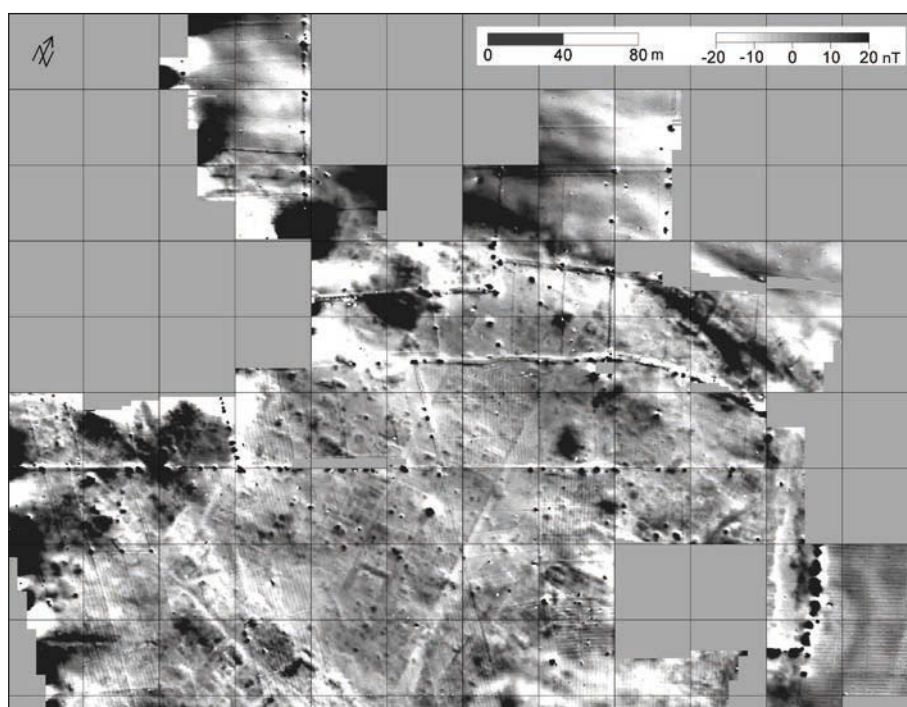

Fig. 2. 'Ezbet Rushdi. The Middle Kingdom settlement featuring an orthogonal plan. Scintrex Smartmag SM-4/4G-special.

In 2000 the survey was continued by Ch. Schweitzer using an FM18 instrument. Other sections of the Thuthmo-side palatial complex in 'Ezbet Helmi were revealed, as well as remains of a city wall from the Horemheb period (1319-1307 BC).

Since 2002 the survey has been continued with two different magnetometers: Fluxgates FM18/36 (from 2007: two FM256) and a caesium Scintrex Smartmag SM-4/4G-special system, with two sensors set in parallel mode measuring the total value of the Earth's magnetic field intensity (identical to the system used in Qantir). The readings with caesium instruments were taken in zigzag mode and after resampling, the measurement grid was 0.25 by 0.50 m.

The area surveyed so far, amounting to 110 ha, is bounded to the west by the longitudinal section of the ancient Pelusiac Nile branch and to the north by the latitudinal stretch (Fig. 1). To the east, the survey encompassed an area east of 'Ezbet Rushdi, at 'Ezbet Machali reaching almost to the southwestern edge of the large area of nearly 200 ha surveyed by Becker and Fassbinder in Qantir.

The survey east of 'Ezbet Rushdi revealed an Early Middle Kingdom settlement with orthogonal layout (Forstner-Müller et al. 2005) (Fig. 2). To the south, remains of the town from the 15th Dynasty have been mapped. In area F/I (between 'Ezbet Helmi and Tell el-Dab'a), a palatial complex from the Hyksos period was discovered (Bietak et al. 2007) (Fig. 3). The dating of these structures is known due to earlier excavations (orthogonal settlement at Esbet Rushdi) or verificatory testing following the magnetic survey (palatial complex in F/I). The survey on the mound of Tell el-Dab'a revealed remains of large buildings which, to judge by their plans, date to the Late Period (Forstner-Müller and Müller 2007). In the area neighbouring with the earlier excavation in F/I, remains of tombs of the 13th Dynasty and Second Intermediate period were registered.

The survey done with caesium instruments provided a clear picture of the paleomorphology of the Nile Delta showing the Pelusiac main branch with river banks and deep water sediments, less rapid flowing side branches and lagoon areas with limnic sedimentation.

The survey was done within the program framework of the Austrian Archaeological Institute in Cairo. Between 2002 and 2007 A. Buszek, P. Kołodziejczyk, M. Kurzyk and D. Świąch participated in the survey. Topographical support

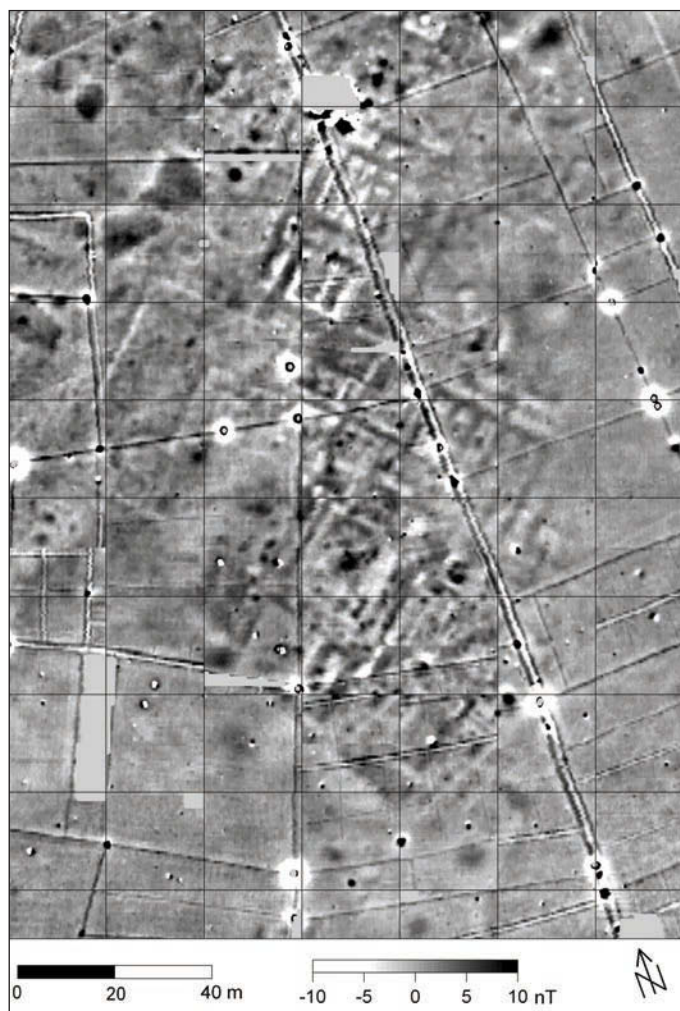

Fig. 3. F/I. The Hyksos period palatial complex. Geoscan Research FM36.

was provided by J. Dorner, W. Müller, A. Hassler, A.-C. Escher and M. Weissl. One of the FM instruments used in the prospection comes under a cooperation agreement between the Polish Centre of Mediterranean Archaeology in Cairo and Programa de Estudios de Egiptología (Consejo Nacional de Investigaciones Científicas y Técnicas, Buenos Aires).

BIBLIOGRAPHY

- Bietak/Dorner/Janósi 2001* M. Bietak/J. Dorner/P. Janósi: Ausgrabungen in dem Palastbezirk von Avaris, Vorbericht Tell el- Daba/°Ezbet Helmi 1993-2000. *Ägypten und Levante* 11, 2001, 27-119.
- Bietak/Forstner-Müller, in print* M. Bietak/I. Forstner-Müller: The Topography of New Kingdom Avaris and Per-Ramesses. In: *Studies in Honour of K. Kitchen*, in print.
- Bietak/Forstner-Müller/Herbich 2007* M. Bietak/I. Forstner-Müller/T. Herbich: Discovery of a new palatial complex in Tell el-Dab^a in the Delta. In: Hawass Z., Richards J. (eds.), *The Archaeology and Art in Ancient Egypt, 2007*, 119-125.
- Dorner 1994* J. Dorner: Ergebnis der Geländeuntersuchungen zur Rekonstruktion der historischen Topographie von Auaris und Piramesse - ein Vorbericht. In: Bietak M., Dorner J., Hein I., Janósi P., *Neue Grabungsergebnisse aus Tell el- Daba und °Ezbet Helmi im östlichen Nildelta 1989-1991. Ägypten und Levante* 4, 1994 11-15.
- Forstner-Müller/Müller/Schweitzer/ Weissl 2005* I. Forstner-Müller/W. Müller/C. Schweitzer/M. Weissl: Preliminary Report on the Geophysical Survey at Ezbet Rushdi/ Tell el- Dab^a in Spring 2004. *Ägypten und Levante* 14, 2005 101-109.
- Forstner-Müller/Müller 2007* I. Forstner-Müller/W. Müller: Neueste Ergebnisse des Magnetometersurvey während der Frühjahrskampagne 2006 in Tell el-Dab^a/Qantfir, *Ägypten und Levante* 16, 2007.
- Herbich 2001* T. Herbich: Archaeological geophysics in Egypt: recent results. In: M. Doneus, A. Eder-Hinterleitner, W. Neubauer (eds.), *Archaeological Prospection. 4th International Conference on Archaeological Prospection, 2001*, 112-113.
- Herbich 2003* T. Herbich: Archaeological geophysics in Egypt: the Polish contribution. *Archaeologia Polona* 41, 2003, 13-55.
- Push/Becker/Fassbinder 2000* E. Push/H. Becker/J. W. Fassbinder: Palast - Tempel - Auswärtiges Amt? Oder: sind Nilschlammauern magnetisch zu erfassen? *Ägypten und Levante* 11, 2000, 135-153.

Irene Forstner-Müller
Austrian Archaeological Institute in Cairo
6a, Sh. Ismael Mohamed, Zamalek, Cairo, Egypt
irene.forstner_mueller@oeai.at

Christian Schweitzer
Schweitzer-GPI, Prospection & Interpretation
Roggenschlag 6, D-30938 Burgwedel, Germany
christian@schweitzer-gpi.de

Tomasz Herbich
Institute of Archaeology and Ethnology, Polish Academy of Sciences
Al. Solidarności 105, 00-140 Warszawa, Poland
tomasz.herbich@gmail.com
herbich@iaepan.edu.pl

GEOPHYSICS AND GEO-ELECTRICAL INVESTIGATIONS INTEGRATING THE GIS OF IUVANUM SURVEY PROJECT

Domenico Fossataro

Key words: *geophysics, geo-electrical, geo-prospections, GIS, field survey, landscape archaeology, digital elevation model*

Iuvanum Survey Project was planned as a joint project among Italian, English and Spanish Institutions in order to analyse as much intensively as possible the mechanisms of settling the area of the Romano-Italic Sanctuary and the Roman municipium of Iuvanum (Chieti- Italy). The focus was on the location of the main sites, their hierarchic organization in different periods and their inter-visibility for reconstructing territorial sub-units and districts. Within the context of the project several seasons of intensive field survey were completed and in the last 4 years also several excavations of some of the sites were organised in order to test the area stratigraphically. In the context of this wide project a multilayer GIS was planned and the aim of last field seasons was the geo-physical and geo-electric investigation of

the most representative sites in order to complete as much as possible the data of the GIS and get a wider picture of the area, integrating the data of the geo-prospections with remote sensing and photo-interpretation both from a geological and an archaeological point of view.

The aim of the data processing in the Survey project of the area of Iuvanum has been, since the beginning, not only the creation of a complete database, but also, and more importantly, the construction of a GIS project which could guarantee as global as possible a view of the mechanisms of the settlement and exploitation of the territory in antiquity. There are numerous GIS programs for this kind of project which can be easily adapted to a wide range of needs; the most common feature of the various GIS products is to correlate the database precisely with the topographic base of the area. However, the methodologies of application of these programs vary from area to area and from project to project, and the organization of GIS in different levels is often very subjective. In our case, in order to get a most detailed view, different cartographic bases have been used for our GIS, including the results of remote sensing, photo-interpretation and geo-physical surveys that are still in progress.

The cartographic base is extremely important in this kind of project and for a GIS project it must be as complete as possible, as well as continuously improvable. At the beginning of the project we began by using cadastral maps and black and white aerial photographic maps with different resolutions and scales, but unfortunately most of them were old. However, in the last two years, thanks to the reorganization of the aerial photographic maps of the region, new images

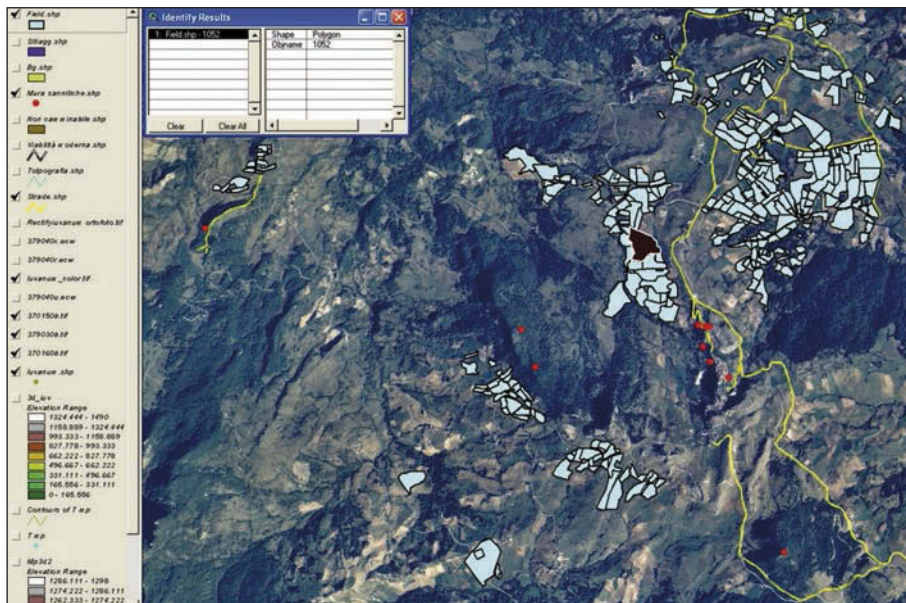

Fig. 1. Iuvanum Survey Project: multilayers GIS.

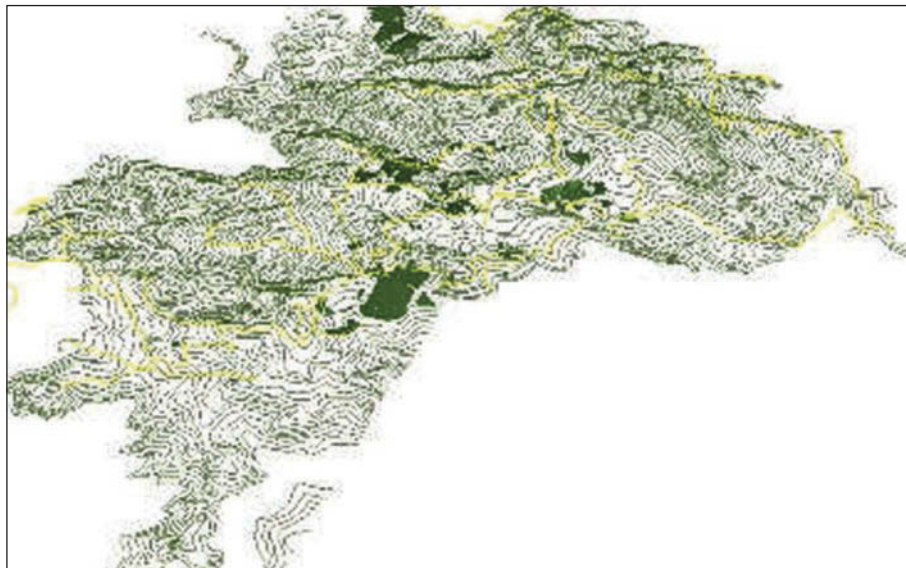

Fig. 2. Iuvanum Survey Project. Topographic model of the area.

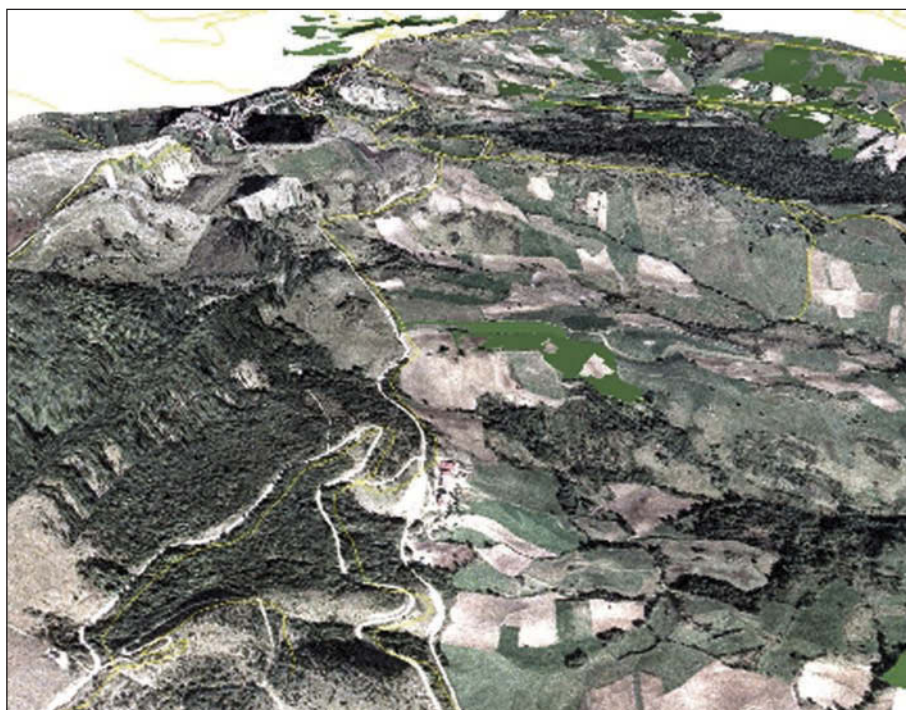

Fig. 3. Iuvanum Survey Project. 3D model of the area.

of the territory have been taken and are available, already horectified and georeferenced, in a digital version and with adjustable image resolutions. In the initial compilation of our GIS, the original cadastral maps and black and white aerial photographic maps were scanned, horectified and georeferenced, and served on different levels, as the only topographic bases for the survey. Then the new colour aerial images of the area, taken in 2000 by VololItalia, were included as a new topographic level of our GIS, in order to make the complete sequence of images easily accessible. The structure of the database of the Iuvanum Survey Project derives from the database of the Sangro Valley Project, maintaining the general basic architecture of the database, in order to allow easy comparison of the data and the merging of the two databases in the future. This will provide a general GIS of the two sample areas in the Sangro Valley, which are closely related historically and archaeologically. The original structure of the database was based on four main linked tables, consisting of the field, site scatter, structure and finds forms, which always depend hierarchically on the field form. We have added a fifth table, the site form, to record the numerous villages, fortified centres and pseudo-urban sites dating from the pre-Roman period to the post-medieval age, which have not been surveyed intensively, but which are particularly interesting and numerous in this area. The different tables allow a differentiation of the data within the database in order to maintain the different levels separately, and at the same time, having linked them, it is possible to have a complete view of the relationships between surveyed fields, finds or structures which have been found and eventual site scatters which have been delimited within the fields.

The organization of the database and the ease of creating crossed links is an extremely important aspect of the organization of a GIS project; in fact, a perfect correspondence and balance among the different levels of the database is fundamental in making a GIS as precise as possible. In this way, the database of the project can be integrated within the topographic context, and individual contextualised data are geographically linked with their areas of find, drawing the limits of fields or site scatters within a shape file. With this GIS structure, new information can be inserted daily, showing directly, either graphically or statistically, the progress of the project. This phase is certainly the most elaborate and problematic, but it enables us to make all kinds of queries, through the use of SQL, and resulting in thematic and chronological distribution maps. The combination of these resulting maps and the study of the topography of the area are important in building a general territorial model and investigating the main dynamics of the local settlement pattern and exploitation of the soil.

Through the analysis of the topographical base of the specific levels of the database in combination with a Digital Elevation Model (DEM) file it is possible to create a Digital Terrain Model (DTM) and reconstruct the distribution of ancient sites, their intervisibility, the different areas of interest and influence of the main sites, and the hierarchical position of sites, using Thiessen Polygons.

Domenico Fossataro
 DAS-Chieti University
 Campus Universitario, Chieti Scalo, Italy
 Via Mazzini 131, 65122, Pescara, Italy
 d.fossataro@gmail.com

PHOTOGRAMMETRY AND REMOTE SENSING IN ARCHAEOLOGY

Alin Frînculeasa - Mădălina Frînculeasa

Key words: photogrammetry, remote sensing, archaeology, benefits and limits, Romania

To understand cultural development and activities from the past, archaeologists try to obtain as much relevant information as possible. Today, a wide range of prospecting methods is available and provides different results and clues to interpretations of archaeological sites. In order to retrieve a maximum of information, prospection data has to be combined and interpreted together. Combination of traditional archaeological prospecting methods can be done on different scales, ranging from landscape to individual features.

Photogrammetry consists of accurate measurement of man-made or natural lands features through the production and use of aerial photographs, and can be supplemented by field-edited surveys. The aerial view can show archaeological landscape in ways that emphasize their most important and valuable aspects. Archaeological interpretation of aerial photographs is not easy.

Remote sensing provides unique clues for recognizing the distribution and relations between objects and phenomena on the earth surface, especially when integrated with DTMs. Nevertheless, the interpretation of the patterns and nature of detected features often needs validation through ground survey. This is particularly crucial in the reconstruction of archaeological landscape, due to modification of the environmental and cultural variables through time.

The different techniques have different success and failure rates depending principally on ambient environmental conditions. However, with some exceptions, the current state of knowledge in Romania is incipient.

In this paper we try to demonstrate various examples of data integration showing the benefits and limits of the applied methods. On second plane we present some preliminary result along with the problems raised by each method of data acquisition in Romania.

REFERENCES

- | | |
|-----------------------|---|
| <i>Adragna 1997</i> | F. Adragna: Interferometrie radar: principe, applications et limitations, Bull. Francaise de Photogrammetrie et teledetection 148, 1997, 17-29. |
| <i>Sabin Jr. 1987</i> | F. F. Sabin, Jr.: Remote sensing-principles and interpretation. New York 1987. |
| <i>Regrain 1996</i> | R. Re grain: La teledetection. Composantes et concepts de la geographie physique. Paris 1996. |
| <i>Vălean 2002</i> | M. C. Vălean: Mediul natural și omul în eneoliticul din centrul Moldovei. Studiu de caz: utilizarea fotografiilor aeriene în studierea modificărilor antropice eneolitice produse asupra mediului natural, referat doctorat. Iași 2002. |
| <i>Vălean 2003</i> | M. C. Vălean: Așezări neo-eneolitice din Moldova, Iași 2003. |

Alin Frînculeasa
Prahova District Museum of History and Archaeology
Toma Caragiu, no. 10, Ploiești, Prahova, Romania
alinfranculeasa@yahoo.com

Mădălina Frînculeasa
Department of Geography, Faculty of Humanities,
Valahia University
130024, Târgoviște, Dâmbovița, Romania
madalina_chitescu@yahoo.com

APPLICATIONS TO LANDSAT THEMATIC MAPPER IMAGERY IN GEOSCIENCES RESEARCH
(SPECIAL VIEW TO GEOLOGY AND ARCHAEOLOGY)

Mădălina Frînculeasa - Alin Frînculeasa

Key words: Landsat Thematic Mapper Imagery, geology, archaeology, Romania

The multi-informational character of the satellite images taken by informational satellites at the end of the 20th century has given remote sensing an ever-increasing significance. In the geological and archaeological field, remote sensing represents a method that can help us verify the results and interpret phenomena and events, using a modern and competitive method of analysis.

The main objective of our research was to determine the possibilities of using the average and high spatial resolution satellite images Landsat 5 Thematic Mapper (TM) and Landsat 7 Enhanced Thematic Mapper Plus (ETM+) in the domain of geological and archaeological research. This derived from our main purpose, that of introducing satellite images and using them on a regular basis in geoscience, according to the current global tendencies, as they appear more and more frequently, not only in geology and archaeology but also in other domains, by comparison with the aerial one (e.g. the Landsat Thematic Mapper application of prospection techniques makes more efficient the recovery of information and makes it possible to reach a higher level of interpretation of archaeological sites before excavation).

This paper examines the use of multispectral sensors in identifying the loci of past human activity and tectonico-structural phenomena with examples in Romania, giving specific emphasis on those remains that would normally go unnoticed if other research methods were used.

REFERENCES

- Biel/van Leeuwen/Zuidema 1996* C. A. de Bie/J. A. van Leeuwen/P. A. Zuidema: The Land Use Database. User's Reference Manual, ITC, FAO, UNEP, WAU 1996.
- Chițescu 2005* M. Chițescu: Structural geological applications of Landsat Thematic Mapper imagery. Conclusion to the analysis of the structural geological elements in the area of Dambovicioara Corridor, Romania. *Lucrările științifice ale simpozionului multidisciplinar internațional "UNIVERSITARIA SIMPRO 2005"*, 27.
- Popescu/Nițică/Marinescu 1996* I. Popescu/C. Nițică/A. Marinescu: Application of the satellite images processing methods and geographica informatinal system (GIS) in the geological survey, *Anuarul IGR* 69, 2006, 314-316.
- Qary 1991* M. Y. H. T. Qary: Application of Landsat TM data to geological studies, Al-Khabt area, southern Arabian shield. *Photogrammetric Engineering and Remote Sensing* 57, 421-429.

Mădălina Frînculeasa
Department of Geography, Faculty of Humanities,
Valahia University
130024, Târgoviște, Dâmbovița, Romania
madalina_chitescu@yahoo.com

Alin Frînculeasa
Prahova District Museum of History and Archaeology
Toma Caragiu, no. 10
Ploiești, Prahova, Romania
alinfranculeasa@yahoo.com

MAGNETOMETER SURVEY AT THE ROMAN TOWN OF CYRENE, LIBYA

Chris Gaffney - Vince Gaffney - Richard Cuttler - Helen Goodchild - Susan Kane - Gareth Sears

Key words: magnetic prospection, Roman town, Cyrene, Libya

The Cyrenaica Archaeological Project (CAP) is an international mission under the direction of Professor Susan Kane, Oberlin College. CAP comprises experts from a range of universities and scientific establishments in North America and Europe who are committed to the investigation of Cyrene and the surrounding area using a range of archaeological techniques.

Cyrene, a designated UNESCO World Heritage site in eastern modern Libya, was the leading city of the Libyan Pentapolis. Settled by Greek colonists toward the end of the 7th century B.C., it remained an active Graeco-Roman city of distinctively Hellenic character until the time of the Islamic conquest (A.D. 643). The first scientific archaeological mission to Cyrene was led by Richard Norton on behalf of the Archaeological Institute of America in the early 20th century. Subsequent foreign archaeological missions from America, Italy, and the United Kingdom have excavated in Cyrene for more than a century.

During the 2006 preliminary field study (Cuttler *et al* 2006) the authors noted the following:

- That the primary requirement of the world heritage site at Cyrene is an adequate base map of contemporary and ancient features to assist in the management and development of the site

- That the value of data from current and future excavations at Cyrene would be significantly enhanced by provision of remote sensed data for the settlement as a whole and that this would support the provision of a management plan for the world heritage site.
- That historical and archaeological data from the town would be enhanced by a regional survey

Experience gained while mapping other townscapes, such as Wroxeter (*Gaffney et al 2000*) and Forum Novum (*Gaffney et al 2004*) suggests that remote sensing will play an important part in the analysis of Cyrene. During the 2007 field season it was decided to trial the multi sensor Ferrex system for large scale coverage of the city. The logic behind the decision to use this system was based on field trials at Wroxeter using a non-magnetic cart which was enabled with real time GPS for navigation and three dimensional data location. While the sensors are not as sensitive as many on the market, the magnetic anomalies within most ancient towns are normally well above the minimum detection level for this sensor. At Wroxeter the system easily matched the results from earlier surveys, partly due to the strength of response, the increased sampling density resulting from 0.5 m traverse separation and a reduction in pre-processing due to exact positioning of data.

The work from the 2007 field season will be presented including aspects of data integration that will be inherent in the analysis of the city.

REFERENCES

- Cuttler/Gaffney/Goodchild/Rossiter/Sears 2006* R. Cuttler/V. Gaffney/H. Goodchild/J. Rossiter/G. Sears: Cyrene archaeological project field survey, GIS and assessment 2006, unpublished report, http://www.cyrenaica.org/CAP_report_2006_rev.pdf.
- Gaffney/Gater/Linford/Gaffney/White 2000* C. F. Gaffney/J. A. Gater/P. Linford/V. L. Gaffney/R. White: Large-scale systematic fluxgate gradiometry at the roman city of Wroxeter Archaeological Prospection 7, 2000, 81-99.
- Gaffney/Goodman/Nishimura/Piro 2004* V. Gaffney/D. Goodman/Y. Nishimura/S. Piro: Discovery of a 1st century AD Roman amphitheatre and other structures at Forum Novum by GPR. *Journal of Environmental and Engineering Geophysics* 9, 2004, 35-41.

Chris Gaffney
Remote Vision Research
Sunny Leigh, Cliffe Lane, Thornton, Bradford
BD13 3DX, United Kingdom
c.gaffney@yahoo.co.uk

Susan Kane
Department of Art Oberlin College
Oberlin, 44074, Ohio, USA
susan.kane@oberlin.edu

Vince Gaffney
Richard Cuttler
Helen Goodchild
Gareth Sears
The Institute of Archaeology and Antiquity
Arts Building, University of Birmingham
Edgbaston, Birmingham B15 2TT, United Kingdom
v.l.gaffney@bham.ac.uk
r.cuttler@bham.ac.uk
H.Goodchild@bham.ac.uk
g.m.sears@bham.ac.uk

HIGH RESOLUTION MAGNETOMETRY AND RESISTIVITY IMAGING IN ARCHAEOLOGICAL PROSPECTING - CASE STUDIES FROM THE TERRITORY OF SLOVAKIA

Vojtech Gajdoš - Miroslav Hajach - Roman Pašteka - Kamil Rozimant

Key words: geoelectrical methods, geophysical instruments, electrical resistivity tomography, high resolution magnetics

Introduction

Technical progress in the branch of new geophysical instrument development allows to use "classical" geophysical methods with high density data acquisition. These data are used for new interpretation and visualisation techniques, which allow to obtain detailed information about explored anomalous objects (*Clark 1990*). These new

instruments include high-sensitivity Cesium magnetometers and resistivity imaging instruments. We have carried out various measurements on different archaeological sites by means of the magnetometer TM-4 from the Australian company GTL and electrical resistivity device Resistar RS-100M from the expired Czech company Geofyzika - in this contribution three selected case-studies have been used.

Biely Kostol - Hallstatt burial barrows site

Hallstatt barrow site in Biely Kostol (small village SW of Trnava) belongs to the relatively recently discovered archaeological sites of the Kalendberg Culture in Slovakia. Major part of the site consists of four burial barrows, which can be recognized on the relief of the Earth surface (site is positioned on agricultural land). The barrows are circular and were built from the centre to the margin (sometimes with a burial chamber close to the centre), the soil was taken from the wide surroundings of the barrow mantle and also from the ditch around the object. Original height of the barrows could be from 2 to 3 m above the actual surface, but over time this elevation was smoothed by weathering processes, and today it is only 0.5-1 m. Diameter of these structures varies from 20 to 30 m (Urminský 2001).

The findings in one of the barrows (structure I., realized in 1999-2000) were represented mainly by ceramics (approximately 21 vessels were found). Part of the wooden burial chamber was opened up. It was a simple log-cabin structure with a wooden floor and supporting pillars in the

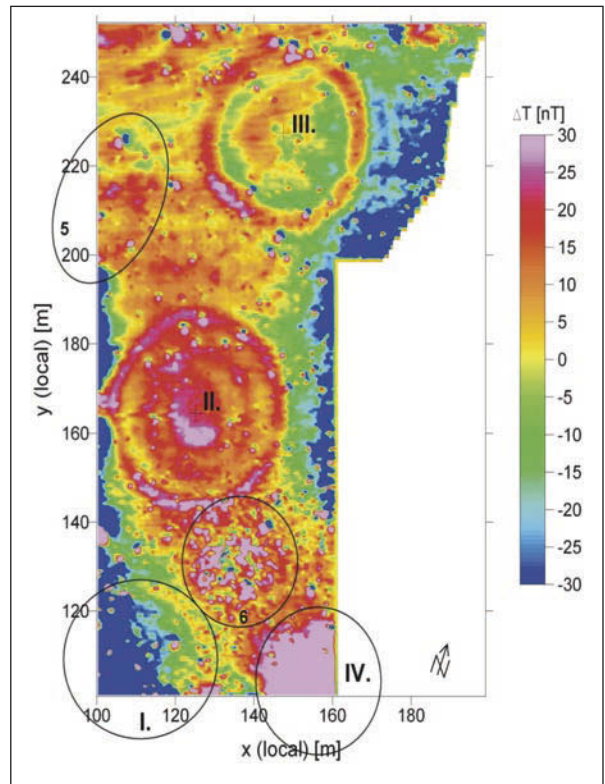

Fig. 1. Image of the anomalous total magnetic field on the site Biely Kostol with indicated parts for interpretation.

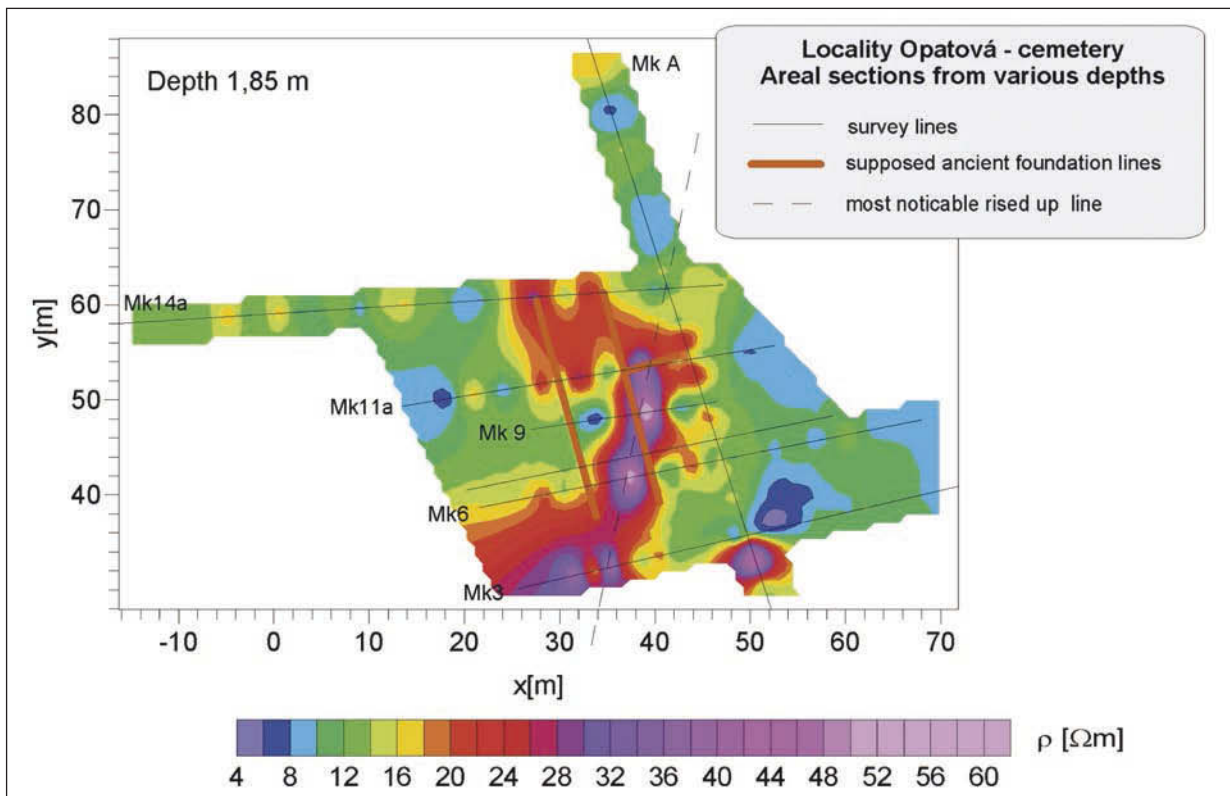

Fig. 2. Horizontal resistivity section from part of the site Lučenec - Opatová.

centre. Geophysical research, realized in summer 2002 was focused on the next barrows structures - mainly on their central part, where the burial chamber should be positioned. Precise measurements of magnetic field could bring a new insight into this very interesting archaeological problem. Data acquisition was performed by means of a high quality Cs-vapour magnetometer TM-4. Surveyed territory was approximately 70x150 m in a series of lines with the distance 0.5 m with a step of 5 cm on each line. Obtained data were processed by means of standard techniques into a map of T field (Fig. 1). Positioning of measurements was realised in a local coordinate system, axes were oriented parallel to the existing fences in the site.

Results from the realised geophysical research brought important results. The map of ΔT field shows two full patterns of barrows, which are manifested by means of concentrated circular anomalies. The pattern of this anomalous field is very close to that obtained in cases of ancient ditch systems (Kuzma/Tirpák 2001). By means of the Earth surface analysis of the site there were expected four barrows - by means of high-sensitivity magnetometry two of them were fully determined (structures II. and III.), one partly (struct. I.) and one did not have the typical response in the magnetic field (struct. IV.). A part of what is probably a new barrow was recognised (structure 5.).

Additionally electrical resistivity tomography (ERT) measurements were realised along two lines, crossing the structure II. High correlation between ΔT field maxima and higher resistivity values along the profiles was followed. This phenomenon is not explained in present and we hope that future archaeological excavations will help us to move forward in understanding this special feature of the site.

Lučenec - Opatová - Cistercian abbey remains

A medieval Cistercian abbey - church is supposed to be situated in the area of Lučenec city, part Opatová. Some artefacts from years 1172-1196 were found, which could be an evidence of the oldest structure in Novohrad territory. It is from this time up to year 1247 we assume that the abbey was established. The abbey played a role in the historical battle between Hussites and Hungarians in 1451.

The Archaeological research has been running for a few years. Last year, geophysical measurements of geomagnetic field (PMG1, proton magnetometer) and electrical resistivity tomography (ResiStar RS-100M) along selected survey lines were realized. Wenner - Schlumberger electrode array with electrodes distance 2m was used for geoelectrical tomography.

Exploration site is located in the area of an old cemetery. Remains of old architecture were found by digging some graves. From understandable reasons there were only limited possibilities to dig classical archaeological probes. Only a minor hole was opened and in the depth of 2 to 2.5 m several narrow tunnels were excavated. Recently, before geophysical survey, underground archaeological probes were dug successfully for remains of old foundations and stone blocks. The remains found are roughly situated along three thick lines (Fig. 2), which could indicate the possible strike of walls.

Survey lines were situated according to local conditions among graves. Though there was a contrast between susceptibilities of old foundations and surrounding clays, considerable effect of disturbing ferrous items in cemetery objects influenced the survey. For these reasons the measured magnetic field did not give convincing evidence about possible presence of architectural remains.

Electrical resistivity tomography method was more successful as a consequence of greater resistivity contrast of studied objects against their vicinity. In Fig. 2 selected parallel lines of interpreted resistivity are visible - depth sections from one part of the studied area. Line Mk11a was situated above the remains found (marked area). There are higher resistive parts on other survey lines, which could also indicate occurrence of wall remains. From measured ERT lines we have constructed vertical resistivity cross sections as a result of inversion process. We have used these results for the creation of horizontal resistivity sections (approx. at levels 1.25 and 1.85 m). Represented maxima connecting line (dashed) differs from supposed foundation lines approx. 20° (Fig. 2).

Poľný Kesov - old church remains

In the cadastre of homonymous village there are known several sites with finds of settlements from several prehistoric periods. Some of the remains were already found at the end of the 19th century. Close to the church was a cemetery, and the whole area was surrounded by a ditch. In 1958, two fragments of foundations and some shards were uncovered by ploughing. The church lies on area of about 30x20 m.

Former church was identified by aerial photography in 2000, and subsequently the archaeological and geophysical survey was done (Samuel *et al.* 2004). The geophysical exploration was carried out by the Archaeological Institute of the Slovak Academy of Sciences - to identify remains of the church, magnetometric and geoelectric surveys were used. Magnetometer Smartmag SM 4G (SCINTREX) Caesium vapour type was used with 2 horizontal sensors (with 0.5 m separation) in the height of 0,3 m with sampling step of 0.2 m. Resistivity profiling was measured in a grid of 1x1 m. Both methods proved the existence of church remains, especially the geoelectrical measurement showed positively the structure of the church plan. Department of Applied and Environmental Geophysics at the Faculty of Sciences CU selected survey lines in the investigated region. Electrical resistivity tomography was used (ResiStar RS-100M) with Wenner - Schlumberger electrode array and 2 m electrodes distance.

On constructed Magnetic map carries features of remains of the church foundations and a ditch around the church. More detailed picture of the church foundations is represented on the electric resistivity map. Selected ERT survey lines (one in W-E direction and two in S-N direction) were situated above the church remains. There exists an observable excellent congruence in the areal representation of resistivity profiling and ERT vertical cross sections (Fig. 3).

Conclusions

Obtained and interpreted anomalous features from high resolution magnetics and electrical resistivity tomography at investigated localities brought some new information, which could be important from the historical point of view. We believe that some of the selected interpreted anomalous objects will be verified by archaeological excavations in near future. The studies were also important from the point of view of methodical aspects of high-definition geophysics.

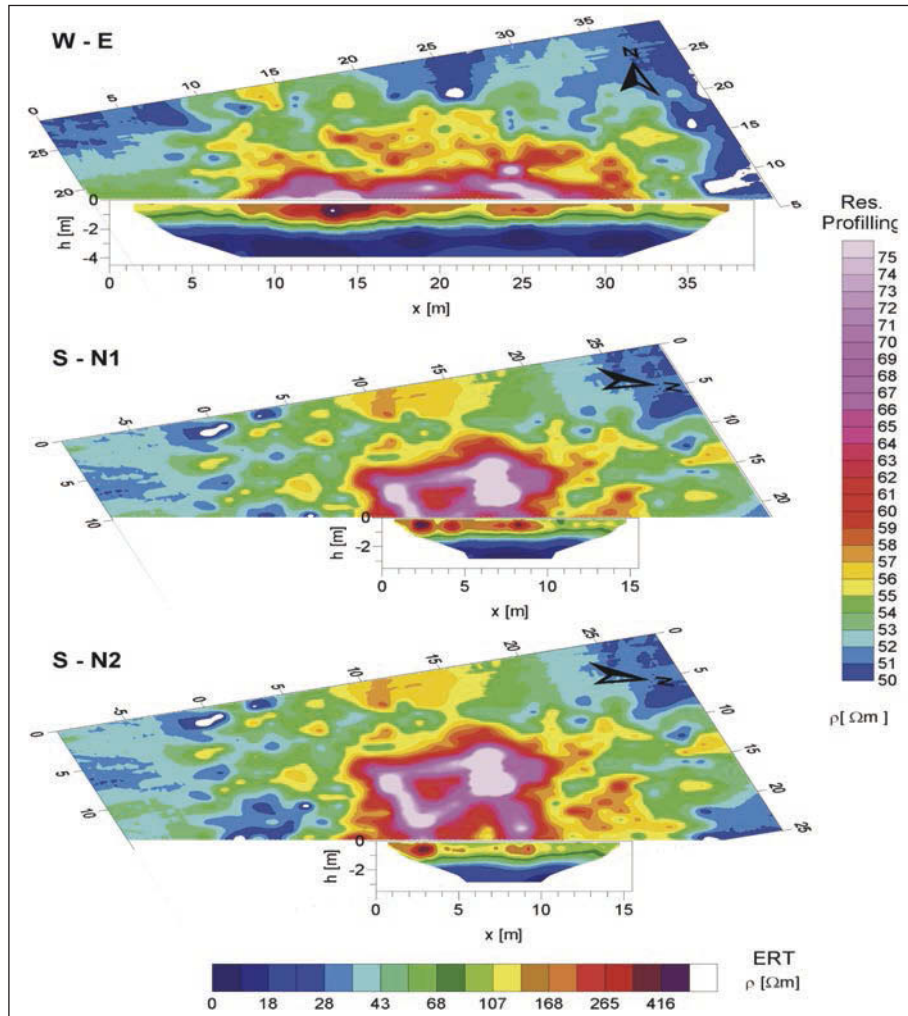

Fig. 3. Measured ERT survey lines versus areal resistivity.

REFERENCES

Clark 1990
 Samuel/Hunka/Tirpák 2004
 Kuzma/Tirpák 2001
 Urminský 2001

A. J. Clark: Seeing beneath the soil. B. T. Batsford Ltd., London.
 M. Samuel/J. Hunka/J. Tirpák: Zaniknutý stredoveký kostol v Poľnom Kesove. Lokality prieskumu a historické súvislosti. In: Zborník na počesť Dariny Bielikovej, Nitra 2004, 329-334.
 I. Kuzma/J. Tirpák: Triple circle ditch system in Golianovo, district Nitra Slovakia. Archaeological prospection, Vienna, 2001, 138-141.
 J. Urminský: Halštatské mohylové pohrebisko v Bielom Kostole. Studia Archaeologica Brunensia M6, 2001, 77-91.

Vojtech Gajdoš
 Miroslav Hajach
 Roman Pašteka
 Kamil Rozimant

Department of Applied and Environmental Geophysics, Faculty of Sciences, Comenius University
 Mlynská dolina G, 84215 Bratislava, Slovakia
 gajdos@fns.uniba.sk
 hajach@fns.uniba.sk
 pasteka@fns.uniba.sk
 rozimant@fns.uniba.sk

HIGHLY INTEGRATED NON-DESTRUCTIVE INVESTIGATION FOR THE RECONSTRUCTION OF ANCIENT SITES

Danilo Gallo - Marcello Ciminale - Helmut Becker

Key words: photographs, caesium magnetometry, archaeological sites, geocoding, GIS

The combined application of non-destructive methods is often the most effective way for deepening the knowledge on large archaeological sites (several hectares). In particular geophysics and aerial photography could yield very detailed information on buried structures (i.e. *Becker et al. 2004*) outlining their location but also in many cases, defining their planimetry. The accurate geocoding of different data sets and the use of GIS. for their integration, allow us to extract the most complete information from a combined study.

In this paper the results of a highly integrated non-intrusive investigation are presented.

The study site is located in the Celone Valley (Southern Italy) and is part of a very important and rich archaeological landscape. It was already identified by archaeologists during the field survey. The remains recovered on the ground belong to different types of structures generally referable to Neolithic, Roman and the Middle Ages.

The main purpose of the combined study was to locate and identify the buried structures.

In cooperation with Otto Braasch of the AARG, in may 2005 a set of oblique coloured photos was acquired to better define the extension of the site and plan the magnetic survey on the ground (Fig. 1). Clear and sharp cropmarks revealed a diffuse presence of archaeological features. In some areas (A, B, C) signals were completely absent because the fields were cultivated with olive trees or vegetables. As the land use could have changed completely from year to year, previous aerial images of the site were searched with the aim of obtaining some information mainly on the area A.

The position and orientation of the grids for the magnetic survey were chosen on the basis of the aerial evidences. Total field measurements were acquired by employing two Scintrex Smart Mag SM4G with four sensors arranged in quadro-sensors configuration and one Geometrix G858 in duo-sensors configuration (*Becker 2001*). Since the cropmarks indicated the double external ditch passing through areas B and C, an attempt of magnetic survey was also tried in the olive groove. The 40 x 40 m² grids were set only in the area B. The acquisition procedure was adapted, trying to minimize the effect of the presence of the trees with the aim of detecting at least the signals related to the biggest features. For practical reasons the duo-sensors configuration was used.

The magnetic grids were geocoded through high accuracy GPS differential measurements. The absolute positions of some features (Ground Control Points) recognizable in the oblique photos were also measured for the subsequent orthorectifying process (*Doneus 2001*).

The magnetic data were processed to reduce unwelcome disturbances (i.e spikes, stripes and zig-zag effect; *Becker 2001*; *Ciminale et al. 2001*). The oblique images were orthorectified by using the Airphoto software (<http://www.uni-koeln.de/~al001/airdown.html>). Afterwards they were used as base map for processing an older set of photographs that showed a good readability of cropmarks in the area A.

All the processed and geocoded data were inserted in a GIS. environment. Fig. 2 shows the superimposition of the different sets of orthorectified photographs with the processed magnetograms. The visual integration of magnetic and aerial signals was improved by applying Digital Image Processing (DIP.) techniques (*Mather 1999*) such as contrast enhancement, RGB spectral bands separation and colour inversion. The image shows a high correlation between aerial and magnetic data and outlines sharply all the detected anomalies (aerial and magnetic), giving an almost complete overview of the site and particularly of the Neolithic settlement.

Significant elements came out by analysing the final results.

In spite of the difficult working conditions, the magnetic survey executed in the olive groove succeeded. Even though at present the processing has not been completed yet, the plan of the double external ditch plus many other structures seems to be already identifiable in the partially processed data. At the same time the multitemporal analysis of the aerial images and their suitable processing allowed an effective integration with the magnetic data and the identification of several Neolithic compounds in the area A, which were not accessible for the geophysical investigation. The magnetic anomalies generally appeared sharper and more visible compared to the correspondent cropmarks. They also pointed out many structures undetectable in the aerial photographs. Through the integrated interpretation of the data, several remains were recognized which belonged to different periods occurred on the site. As it specifically concerns the Neolithic settlement, it is worth of noting that in the eastern surveyed area, the magnetic anomaly connected to the outer external ditch cannot be recognized, while other signals that refer to Neolithic structures are well-visible. This could mean that the external ditch was planned but not finished.

Finally, in order to verify the high compatibility and thus integrability of the magnetic data acquired by the two different magnetometers which were arranged and moved in different ways, one more day was spent in the field to survey the tested area with both configurations. Results are very satisfactory.



Fig. 1. Aerial oblique photo acquired in 2005. The cropmarks reveal the presence of bedded structures of different ages. The archaeological signals are completely missing in some areas (delimited with a black line) owing to the presence of vegetables or olive trees in place of wheat.



Fig. 2. Processed magnetograms displayed in 256 grey tone (-25 white, +25 black) nT, and overlapped to the orthorectified aerial photographs. The magnetic and aerial data appear highly correlated. The good readability of the signals was achieved after all the processing procedures and by applying DIP techniques.

REFERENCES

- Becker 2001* H. Becker: Duo- and Quadro-sensor Configuration for High Speed/High Resolution Magnetic Prospecting with Caesium Magnetometer. Magnetic Prospecting in Archaeological Sites. Monuments and Sites, VI, München 2001, 20-25.
- Becker/Ciminale/Gallo 2004* H. Becker/M. Ciminale/D. Gallo: Integrated Technologies for Archaeological Investigation; the Celone Valley Project. 1st Int. Conf. on Remote Sensing Archaeology, 18-21 Oct. 2004 Beijing (China), 2004, 71-74.
- Ciminale/Loddo 2001* M. Ciminale/M. Loddo: Aspects of magnetic data processing. Archaeological Prospection 8, 2001, 239-246.
- Doneus 2001* M. Doneus: Precision Mapping and Interpretation of Oblique Aerial Photographs. Archaeological Prospection 8, 2001, 13-22.
- http* <http://www.uni-koeln.de/~al001/airdown.html>. Last date of access 11/01/07.
- Mather 1999* P. M. Mather: Computer processing of remotely-sensed images. An Introduction. New York 1999.

Danilo Gallo
Marcello Ciminale
Department of Geology and Geophysics
Campus Universitario 70125 Bari, Italy
d.gallo@geo.uniba.it
marci@geo.uniba.it

Helmut Becker
Becker Archaeological Prospection, Loischweg 32
82547 Beuerberg, Germany
becker.mag@googlemail.com

THE GREEK COLONY TANAIIS CASE STUDY: INTEGRATED PROSPECTION APPROACHES

Gennady Garbuzov - Irina Viktorovna Tolochko

Key words: Northern Black Sea region, lower reaches of the Don River, Greek colony Tanais and its agricultural zone (Chora), ancient cultural landscape

For centuries, the region of the Lower Reaches of the Don River (Nizhneye Podonye) used to be a contact zone between the representatives of different ethno-cultural traditions. In the ancient world, close contact and interaction of Hellenic and Barbaric elements promoted creation of a unique culture, having generated the character of the Northern Black Sea Region (Severnoye Prichernomor'ye) of the second half of the 1st millennium BC. till the first half of the 1st millennium A.D. The town of Tanais, being the most remote to the northeast centre of the ancient civilization (IIIrd century A.D. - Vth century A.D.), played a special and significant role in this process. In the first centuries A.D. Tanais was inseparably linked with the Bosporan kingdom over the whole history of its existence, and served as a link in the economic and political ties of the ancient Bosporus with steppes populations of Priazov'ye and Prydon'ye. It became the central regional and economic zone of the Lower Reaches of the Don River settlement and consisted of a group of fortified settlements, stretching out from the west to the east. During the whole period of its existence, among the main characteristics of the settled culture micro region in the Lower Don Region remained the following: compactness, territorial remoteness from the mother country, i.e. from the main territory of Bosporus, and its complete (undivided) nomadic environment.

Complex ethno-cultural situation was expressed in a peculiar development (evolution) of the ancient city state of Tanais and its neighborhood, located in the Lower Reaches of the Don River and being rich in manifold diverse and different-type archaeological artifacts such as fortified agricultural settlements of Tanais Chora, or large burial mounds of Sarmatians tribes.

On the whole, the region of the Lower Reaches of the Don River gives one a unique opportunity to apply both methods and technologies of the archaeological geo-information science and non-destructive search archeology, as well as electronic registration and joint spatial analysis of all the elements of the richest regional archaeological heritage. The application of such methods tends to become particularly relevant because of the intensive destruction of the material attributes of this original cultural heritage, being hidden in a modern landscape under the impact of the accelerated economic developing of the territory over the recent years.

The general purpose of the study consists in a theoretical substantiation and working-out of the optimal strategy and methodology of a complex data ware for a series of archaeological studies in the field of the ancient archaeology, being characterized both by the scrutiny of the problems of the spatial analysis and by the renaissance of the

ancient cultural landscape. The archaeological investigations of the regional ancient cultural landscape, being held within the frames of the uniform universal geo-information environment and based both on methods and analytical tools of modern archaeological geo-information science and geophysics, are organized with the region of the Lower Reaches of the Don River as an example.

In practice, the whole of the complex of the studies is realized through the creation of a specialized archaeological geo-information project, uniting all spatial data types. Among the aforementioned are archival archaeological databases, thematic data on properties and characteristics of the natural environment and modern landscape, data on geophysical and archaeological field shootings, as well as data on the remote sounding of the Earth. Within the archaeological geo-information project we are planning to carry out practical non-uniformly scaled studies of properties, structures, internal interrelations of various components of the ancient cultural landscape in the near-by and far districts of ancient Tanais, geographically corresponding to lower reaches of the vast flood-lands of the Don River and its delta, as well as to the adjoining flat steppe sites. On the basis of such studies, the construction and objective check of a series of models is assumed. Among the former are: 1) predicative models, i.e. models, forecasting the distribution of various classes of archaeological objects within the limits of the territory under investigation; 2) models describing social and economic spatial relations and evolution of the regional systems of settlements; 3) models reflecting perception and understanding of the outward phenomena by the ancient societies and individuals.

One of the most significant specific targets in modeling the spatial organization of the neighborhood of ancient Tanais is the study of its political, administrative, and economic structure, as well as the analysis of its time variability. The guiding lines here are the distinctive features of the spatial distribution of the well-known archaeological artefacts, with the comparative analysis playing a significant part on the territory of the project with available natural resources.

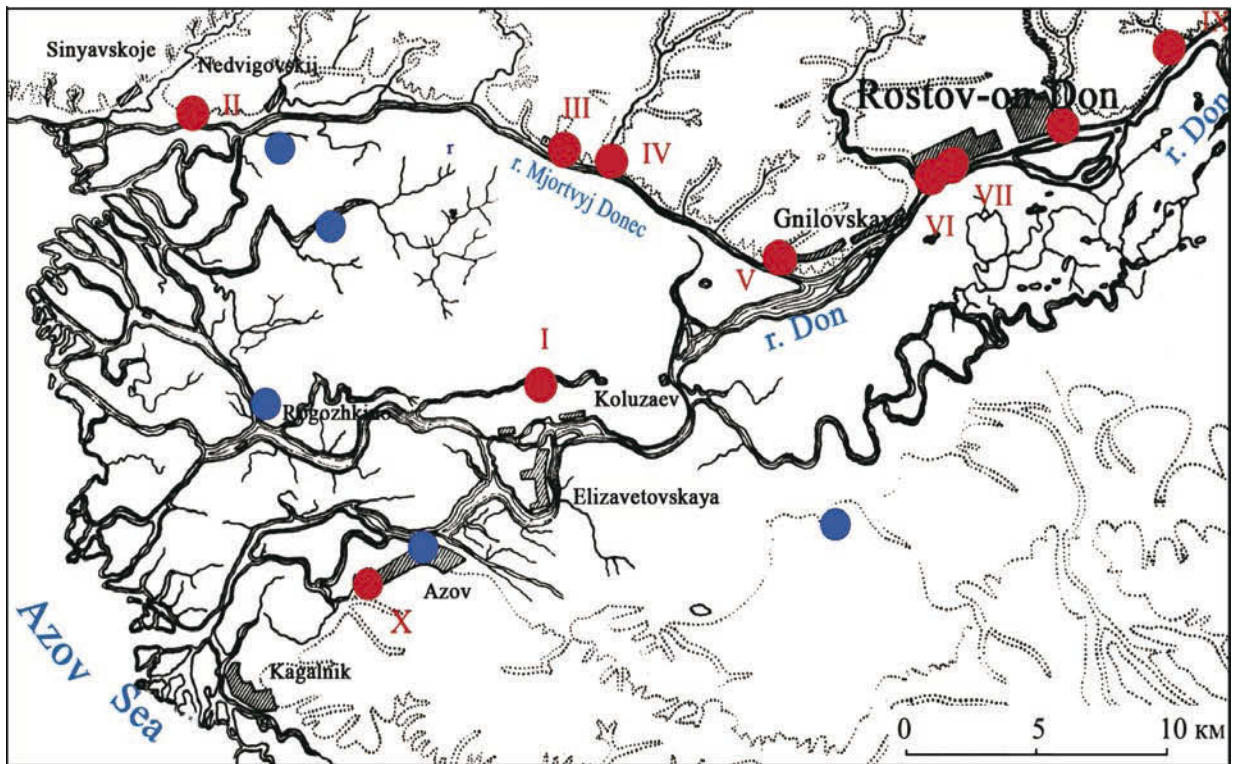

Fig. 1. The map of settlements of Tanais Chora. The view of Don delta. Tanais - the northernmost centre of the ancient civilization.

The universal character of the archaeological project, being presently worked-out, will allow its application for the monitoring of the historical landscapes condition and especially protected territories, such as, for example, a unique landscape of the delta of the Don River. The results of the studies will serve as a scientific substantiation of a series of actions for protection of the natural and cultural heritage of the region.

Gennady P. Garbuzov
South Regional Information and Analytical Centre
Sokolova Ave, 52 of 242
344006 Rostov-on-Don, Russia
g_garbuz@mail.ru

Irina Viktorovna Tolochko
The Southern Scientific Centre
of the Russian Academy of Sciences
Chehova str. 41, Rostov-on-Don, Russia
archaeology@mmbi.krinc.ru

GEOMAGNETIC SURVEY AT THE MEROITIC SETTLEMENT HAMADAB, SUDAN

Thomas Goldmann - Ronny Wutzler - Beate Mekiffer - Pawel Wolf -
Mohamed Abdelwahab Mohamed Ali

Key words: magnetic prospection, Sudan archaeology, Hamadab, Kingdom of Kush

Abstract

Three kilometres south of the Meroitic capital Meroë-City two ancient settlement sites are situated on two hills in the area between the village Domat al Hamadab in the northern part of the modern Sudanese town Kabushiya and the Nile. With an extension of 200x250 m (the northern hill) and the 250x500 m (southern hill) the sites have an area comparable to Meroë-City. A settlement of both sites in the classic and late Meroitic period is evident from findings and excavations. In 1914, the temple B1000 was excavated by the University of Liverpool. Remarkable for a rather small temple like B1000 (24x8 m) are two stelas, of Queen Amanirenas and Vize King Akinidad, which were found in front of the temple, showing Meroitic inscriptions which have not been translated yet.

New excavations, carried out in the north-east of temple H1000 by the University of Shendy/Sudan and the Humboldt Universität zu Berlin/Germany showed a dense net of outlines of houses from mud bricks and a 2.5 m thick city wall from mud bricks with an outside shell of fired bricks. The excavated part of the city wall showed an orthogonal corner in the north-east. Amassments of red bricks in the west, outside the city wall could be the remains of large representative buildings. Dumps of ashes, bones, pottery shards and iron slags, outside the city wall in the south and east of the site indicate a highly developed industrial art. Except the temple all excavated buildings inside the city wall are made of non-fired mud bricks with a wall thickness of one stone.

As resulted from the magnetic mapping, the city wall has a shape comparable to the basic structure of a Roman military camp (castrum), but otherwise some important features of a castrum are missing. It is assumed that the ancient Hamadab was an urban settlement with both a military and civil purpose.

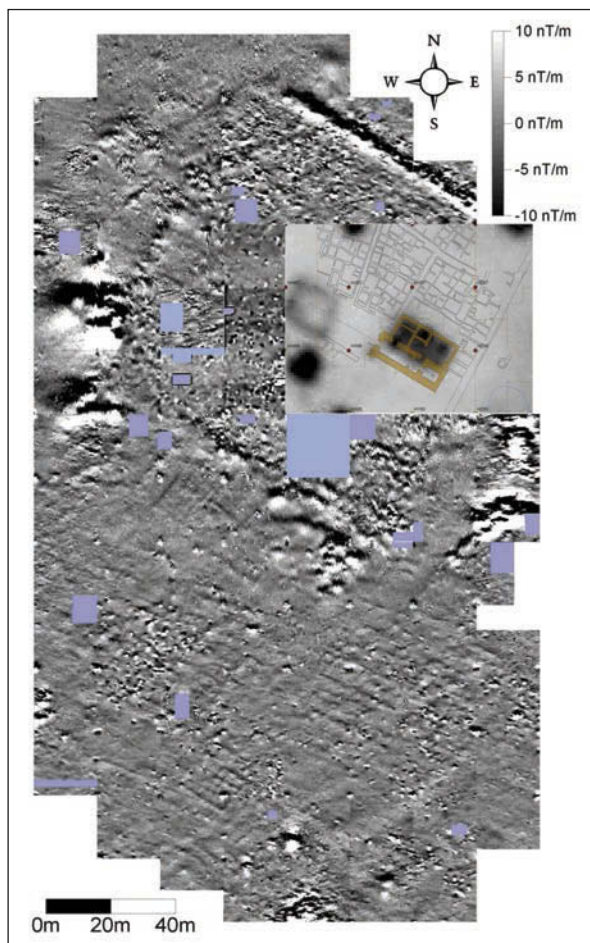

Fig. 1. Magnetic map of the Meroitic settlement Hamadab with embedded excavation plan.

Method and Equipment

The magnetic survey took place in March 2006 and February 2007. The magnetic gradient was measured with a cycle time of 0.2 seconds, using an Overhauser proton precession magnetometer GSM 19. After the mathematical data processing by our own software the map was displayed using Surfer®. The mapping provided us with a grid of data with nearly 12 cm between points and a distance of 25 cm between the lines for magnetic mapping. This very narrow line to line distance was due to the thin walls of the excavated buildings. Before the magnetic survey the surface had to be cleared from red bricks which were scattered all over the site, because they would cause a high magnetic noise.

Results

Within the two seasons the area of the northern hill was mapped nearly completely. Fig. 1 shows the magnetic map with an embedded excavation plan. The grey-blue coloured areas could not be measured because of vegetation. The large Building in the excavated area is temple H1000.

The main structure in the magnetic map is the city wall of rectangular shape with a sloped south-west corner. The north-west corner shows an orthogonal shape but additionally there is also a sloped wall to be seen. Maybe these are remains of two construction periods. The magnetic anomaly of the city wall has a sharp north to south polarisation with gradient values up to +/-100 nT/m.

Inside the city wall a lot of strong magnetic anomalies, resulting from fired bricks, is present but clear structures are not identifiable because of the high magnetic noise of the irregular scattered red bricks below the surface and/or the ruinous state of the buildings from fired bricks. Only in the south east corner the outline of a rectangular building is to be seen. Some straight lines, maybe showing streets, are recognisable in the north. The structures of the mud brick buildings inside the city wall vanish in the noise of the fired bricks.

At the sloped edge of the south east corner of the city wall two large anomalies, resulting from fired bricks, could be the remains of two monumental buildings or, maybe embankments of an assumed port (?).

Outside the city wall the magnetic anomalies are much weaker, except those resulting from the iron sledge dumps in the south and the east. In the south of the castle several ensembles of mud brick buildings are visible. Just in front of the south-west city wall a great rectangular building with wide inside rooms is to be seen. All the other houses have nearly the same orientation like the city walls and are arranged in several ensembles in the south of the fortification.



Fig. 2. A view of the site Hamadab showing an example of the excavated mud-brick walls.

REFERENCES

Garstang

J. Garstang: Fifth interim Report on the Excavations at Meroë in Ethiopia, 1914-1916, LAAA7, 1-24, pls. I-IX.

Wolf 2002

P. Wolf: Die Ausgrabungen in hamadab bei Meroë - Zweite Kampagne, Frühjahr 2002, der Antike Sudan 13, 105-111, Farbt. 4-6.

Wolf/Nowotnick 2006

P. Wolf/U. Nowotnick: Hamadab - a Meroitic urban settlement, excavations 2001-2003, Archéologie du Nil Moyen 10.

Thomas Goldmann
Ronny Wutzler
Beate Mekiffer
Institut für Technologie und Umweltschutz e.V.
Grünauer Straße 33
D-12524 Berlin, Germany
t.goldmann@t-online.de

Mohamed Abdelwahab Mohamed Ali
Technische Universität Berlin
Institut für Angewandte Geowissenschaften
Ackerstraße 76
D-13355 Berlin
mohdabdwahab@yahoo.com

Pawel Wolf
Fa. Lupus Archäologische Dienstleistungen
Langnower Straße 13
D-16928 Langnow, Germany
pwolf@skydsl.de

MULTI-SCALED APPROACHES OF A RENEWED SURVEY PROGRAM INTO THE PLAIN OF PERSEPOLIS (CENTRAL FARS, IRAN). DID EVERYONE LIVE IN PALACES DURING ACHAEMENID TIMES ?

Sébastien Gondet

Key words: multiscaled survey, geophysical, systematic surface survey, Achaemenid, Persepolis

The Persepolis plain, also known as the Marv Dasht plain, is located in the centre of the Iranian province of Fars, some 50 km north of Shiraz. Although in a semi-arid climate, this mountain-bordered plain is one of the most fertile of Fars, and this especially from the time when a big dam was constructed for irrigation in the late sixties. Since then, the plain has not only witnessed an agricultural intensification but also an increased urbanisation, due to establishment of industries around the city of Marv Dasht. This dramatic change results in a steadily rising pressure on the archaeological heritage, especially on the highly vulnerable tells.

The archaeology of the centre of the Achaemenid Empire (560-330 BC) is characterised by a well-known monumental palatial architecture. The foundation of these royal centres, their rich textual records and documented secondary occupation traces (canals, quarries, dams) might suggest a renewed occupation of the region. Nevertheless, even though several tell-oriented surveys were carried out in the last seventy years, the very nature of the hinterland to sites like Persepolis or Pasargadae is only known in a limited number of settlement mounds.

Intensive tell-oriented surveys were conducted in the 1970's (*Alden 1980; Jacobs 1979; Sumner 1972*) and these are to be credited for our present-day understanding, especially for the timeframe stretching from the Neolithic to the end of the Bronze Age. However, numerous questions still remain as to the occupation during the first millennium BC and the lack of archaeological evidence corresponding to this later period. Although the Achaemenid and transitional periods are of course dealt with in these past surveys, scholarly focus has primarily drawn on the earlier periods, while for the Achaemenid period interest and excavation efforts still concentrated on the palatial complex of Persepolis.

In close connection with renewed research of the royal zones themselves, particularly in Pasargadae, the joint Iranian-French survey program aims to provide a more complete and diverse image of the Achaemenid presence and its impact on the surrounding landscape. This entails revisiting known sites, evaluating the presence and characterisation of Achaemenid elements and the start of a systematic survey into the zones thus far lacking archaeological traces: fields and piedmonts. The first seasons (2005-2006) already proved to be very instructive, as they confirmed the archaeological potential of these new zones and highlighted different methodological problems linked to the intense agricultural land use. These problems, together with the current state of archaeological research, need a wider scope, ranging from the regional scale, over off-site structures (canals, dams, roads,...) to the area of the site itself (geophysics, topography, aerial photography,...).

First stage consisted of revisiting reported sites with an assigned Achaemenid date and this in order to evaluate their archaeological potential for more thorough studies. As such, it was also an opportunity to get a better idea of what types of ceramics and settlement patterns characterise the Achaemenid period. We found ourselves confronted with the destruction of numerous sites, due to the intensified agricultural practice. Field observations and estimates indicate that more than 30% of the Achaemenid sites have been levelled and that, when only taking into account the mounded site, more than 50% are lost. Comparing our results with those of previous surveys, the resulting number of Achaemenid sites to be taken into account is quite poor, and our observations bring us to a more cautious re-evaluation, since the presence of Achaemenid elements could not always be reconfirmed. Nevertheless, one conclusion became evident: possible Achaemenid sites are generally low in height and show a very low density of diagnostic sherds. This could explain their high level of destruction as well as difficulties in the field to locate them.

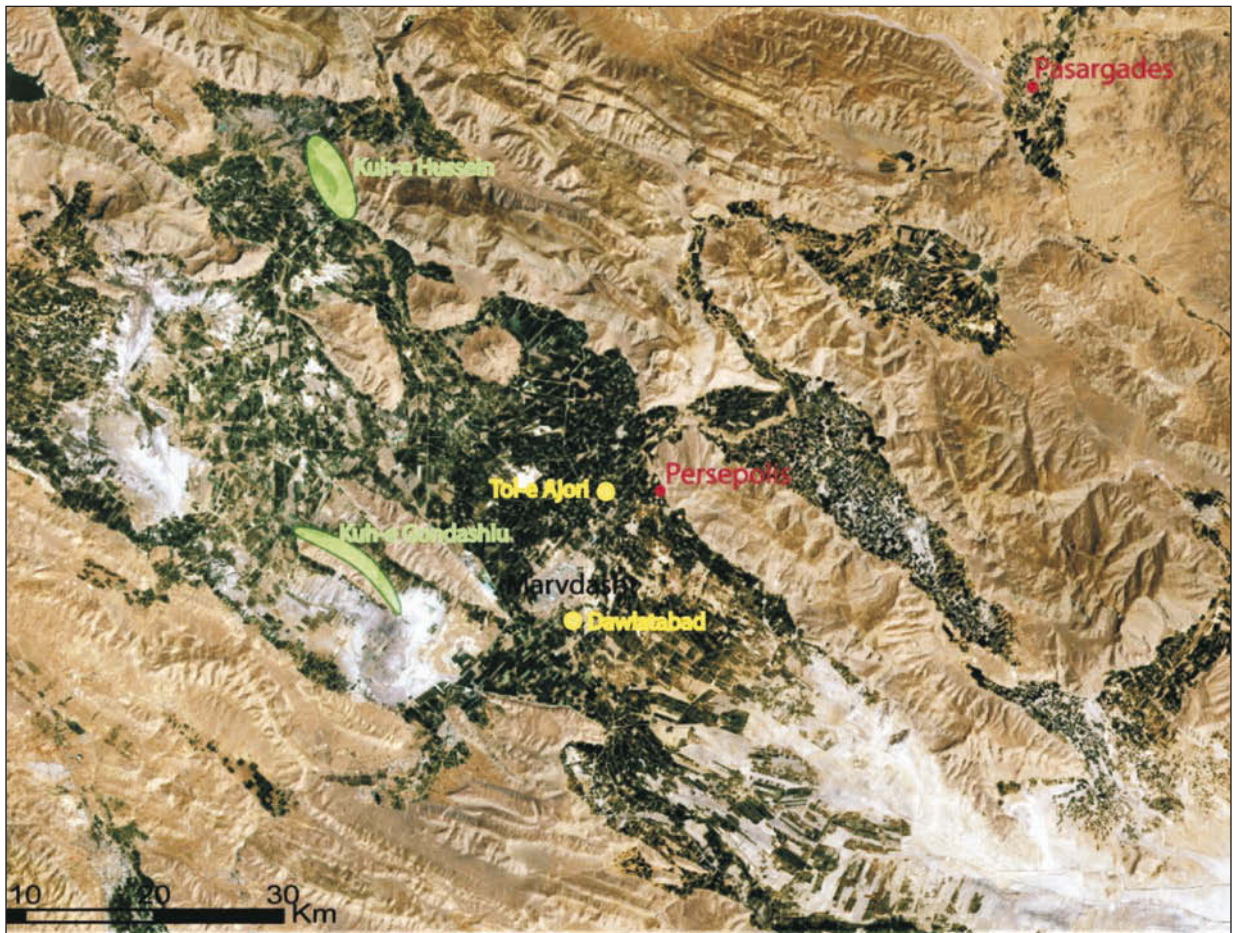

Fig. 1. Landsat images composition of the Persepolis plain (green areas correspond to piedmont surveyed, geophysics surveys have been conducted on sites tagged with yellow points).

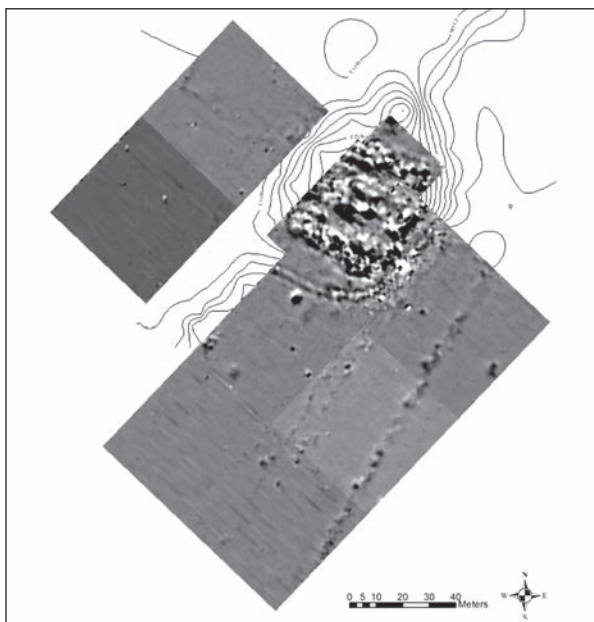

Fig. 2. Magnetic gradient map of site called tol-e Ajari within Firuzi northeast of archaeological area, the survey has revealed a squared baked brick building (level line each 20 cm, magnetic gradient scale -10/+10 nT).

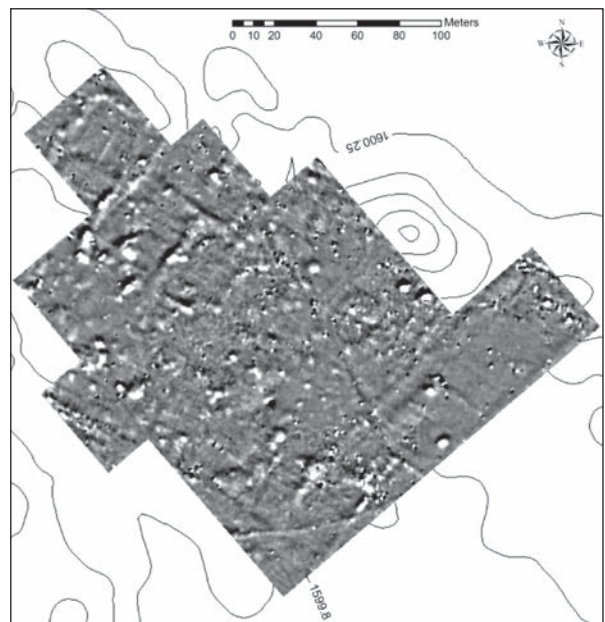

Fig. 3. Magnetic gradient map of Dawlatabad site (level line each 15 cm, magnetic gradient scale -3/+3 nT).

Giving the large destruction of sites on the plain and the somewhat doubtful character of those sites still preserved, one must also look elsewhere for elements of Achaemenid occupation. Therefore, systematic test surveys were also undertaken on two piedmont-zones (Kuh-e Hussein and Kuh-e Gondashlu piedmont areas - Fig. 1). These areas are still quite well-preserved from destruction and they also have the benefit of being spatially limited. On the other hand, with the proximity of several wells and arable land, such areas are also favourable for human occupation and could finally highlight possible variations in settlement patterns.

No clear evidence of Achaemenid occupation was found along these piedmonts, although some unknown ceramic collections could be attested. Even though it is quite impossible to determine their date without any stratigraphy reference, these artefacts might well be linked with occupations during less studied transitional periods. In such a way, the systematic survey of piedmonts provides unseen archaeological artefacts, as well as high number of new and preserved archaeological sites.

In a similar respect, magnetic surveys have been carried out on reported Achaemenid sites that are still well preserved. Most of these have been conducted on sites with associated architectural remains, almost all in the vicinity of Persepolis (for example Tol-e Ajori - Fig. 2).

On the other hand, a magnetic survey was also undertaken on a site in the centre of the plain, called Dawlatabad (Fig. 3). This unrounded surface site presented quite a high concentration of sherds of a possible Achaemenid date. Although the site might well be another levelled mound, the resulting geomagnetic map shows several anomalies resembling a clear architectural layout, probably built out of mud bricks, indicated by the shape of the anomalies and the low response values. For sure, the surveyed area needs to be enlarged to get a better idea of the spatial organization of the settlement. But already from this limited survey large-spaced buildings can be distinguished and show that geomagnetic survey can shed light on the spatial character of some of these low-visibility surface sites.

The main objective of this lecture is to present the results of this first stage of the ongoing research, and will focus on the characters of the Achaemenid occupation (site morphology, environment location, attested diagnostics sherds,...), and first of all concentrate on the combination of systematic surface survey and geophysical survey.

REFERENCES

- Alden 1979* J. R. Alden: Regional Economic Organization in Banesh Period Iran, Ph.D., Department of Anthropology, University of Michigan, Ann Arbor 1979.
- Jacobs 1980* L. Jacobs: Darvazeh Tepe and the Iranian Highlands in the Second Millennium B.C., Ph.D., Department of Anthropology, University of Oregon 1980.
- Sumner 1972* W. Sumner: Cultural Development in the Kur River Basin, Iran: an archaeological analysis of settlement patterns, Ph.D., University of Pennsylvania, Philadelphia 1972.
- Sumner 1986* W. Sumner: Achaemenid Settlement in the Persepolis Plain, *American Journal of Archaeology* 90, 1986, 3-31.

Sébastien Gondet

Maison de l'Orient et de la Méditerranée - UMR 5133 Archéorient 7,
rue Raulin F-69365 Lyon Cedex 7, France
sebastien.gondet@laposte.net

UNDERSTANDING OF THE SUCCESSION OF GEOMAGNETIC ANOMALIES DUE TO A COMPLEX DEFENCE SYSTEM: THE CASE OF AL-RAWDA (SYRIA)

Sébastien Gondet - Christophe Benech

Key words: magnetic survey, excavations, defence system, Early Bronze Age, Al-Rawda

The site of Al-Rawda, which has been excavated since 2002 by a French and Syrian team, is located in the Shamiyeh, on the very edge of Early Bronze Age settlements in the Syrian steppe lands (*Castel & al. 2005*). The presence of well-preserved archaeological levels from the latter part of the Early Bronze Age just below the surface has led us to carry out a magnetic survey on the tell during autumn 2003 and 2005 in order to understand the spatial organization of the city and its surroundings.

This survey has revealed a dense settlement plan (Fig. 1), organised around a radial and concentric street network system, which is probably the result of a pre-established planning (*Gondet/Castel 2004*). The domestic and monumental buildings respect the general organisation of the town. These survey results combined with information obtained through excavations allow us to consider the site of al-Rawda located in a bitter semi-arid area as a real town with these multiple attributes (defensive, residential, economic, religious, funerary), at least in the last phases of occupation at the end of the Early Bronze Age.

First field surveys and topographic works on the site helped to seek fortification around the site. The stone foundations of a huge wall were visible on the surface on the border of tell. Archaeologists were able to assume that

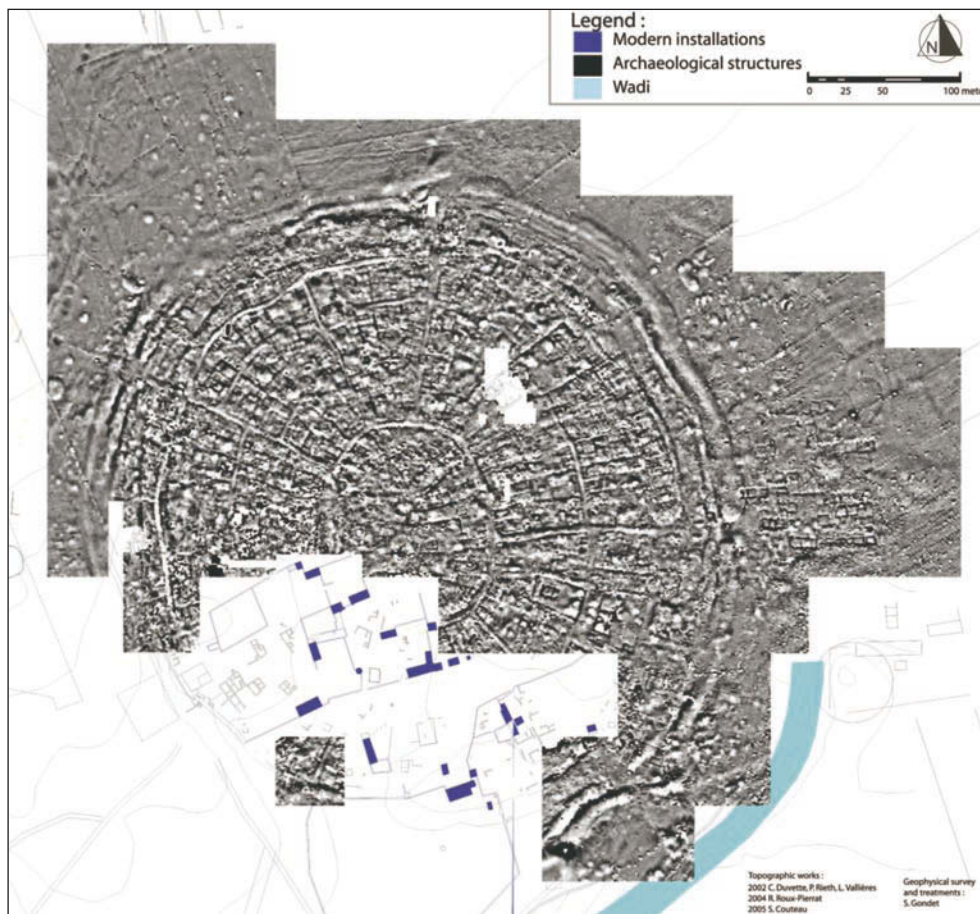

Fig. 1. Geomagnetic gradient map of Al-Rawda (magnetic gradient scale -5/+5 nT).

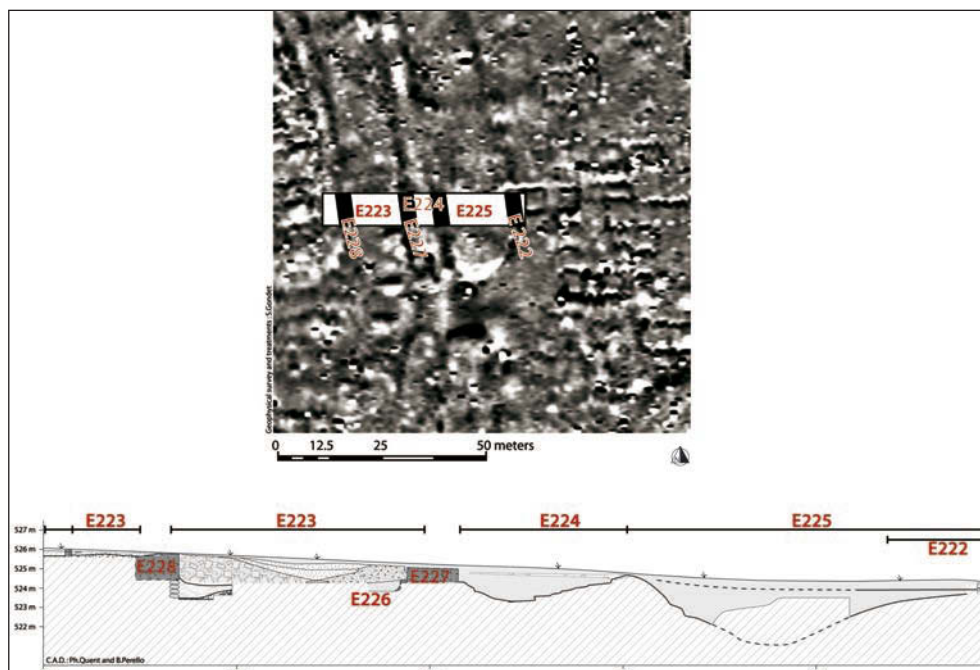

Fig. 2. Comparison between section across Al-Rawda defence system and geophysical survey results (magnetic gradient scale -5/+5 nT).

this structure was not continuous but consisted of succession of linear sections. Therefore, when excavations began, the defence system was considered as a single line of rampart: this assumption has not been disproved by two small archaeological soundings operated on the western and northern ramparts. Geophysical survey allows us to review this assumption, and reveals a more complex 30 m wide defence system around the town fringes. Although the survey renewed our understanding of the defence system of the site, the nature of the anomalies succession along the border of the site was quite hard to specify. At this stage, the only possible conclusion was to affirm that the starting hypothesis of a single rampart was false. The lack of reference on the defence system for this period and the unusual value and shape of some anomalies give accurate interpretations though.

In order to determine the nature of this complex defence system, a 50 m long trench was dug across it east of the site. It allows us to notice that the town was surrounded by a succession of two ramparts and two ditches (Fig. 2). The outermost ditch is 15 m wide in the mean, the other one is 8 m wide. Both are covered with a sort of coarse concrete.

It is therefore interesting to reconsider the variations of the magnetic signal following the different type of constructions which have been laid out for the defensive system of Al-Rawda. If the "geophysical signatures" are clearly identified, it is then possible to characterize the whole system of fortifications and to follow its evolution and eventual modifications.

The study of the Al-Rawda defence system illustrates an interesting dialogue between the different archaeological research methods. A detailed interpretation of the magnetic gradient map helps to highlight the main characteristics of the fortifications, their evolution which reflect the life of the city (period of war or peace, expansion...) and their relation to the city planning.

REFERENCES

Gondet/Castel 2004

Castel/Archambault/Barge/Boudier/Courbon/Cuny/Gondet/Hervieux/Isnard/Martin/Monchambert/Moulin/Pousaz/Sanz 2005

S. Gondet/C. Castel: Prospection géophysique à Al-Rawda et urbanisme en Syrie au Bronze ancien, *Paléorient* 30/2, 2004, 93-110.

C. Castel/O. Archambault/O. Barge/T. Boudier/A. Courbon/A. Cuny/S. Gondet/L. Hervieux/F. Isnard/L. Martin/J.-Y. Monchambert/B. Moulin/N. Pousaz/S.Sanz: Rapport préliminaire sur les activités de la mission archéologique franco-syrienne dans la micro-région d'Al-Rawda (Shamiyeh): deuxième et troisième campagne (2003 et 2004), *Akkadica* 125, 2005, 29-73.

Sébastien Gondet
Christophe Benech

Maison de l'Orient et de la Méditerranée - UMR 5133 Archéorient 7
rue Raulin F-69365 Lyon Cedex 7, France
sebastien.gondet@laposte.net
christophe.benech@mom.fr

MAGNETOMETRY ON THE GEOGLYPHS OF PALPA AND NASCA (PERU)

Tomasz Gorka - Jörg W. E. Fassbinder - Karsten Lambers

Key words: magnetic prospection, horizontal gradiometer, geoglyphs, Nasca, Peru

The geoglyphs of Palpa and Nasca in southern Peru are considered one of the greatest mysteries of archaeology (Aveni 1990). Thousands of lines, cleared fields and figures were carved on flat plateaus in the desert, the so-called pampas, during the Paracas and Nasca cultures (800 BC - 650 AD). Ever since the first report of Peruvian archaeologist Toribio Mejía Xesspe in 1927, serious archaeological investigations have by far been outnumbered by unscientific interpretations. The geoglyphs of Palpa, in the northern Nasca basin, have been studied in detail with archaeological methods since 1997 by the Nasca - Palpa Project (Reindel/Grün 2006) supported by the German Federal Ministry of Education and Research (BMBF). In the framework of this project, we conducted in 2003 the first prospection with geophysical methods in the pampa (Fassbinder/Reindel 2005). During the following field seasons we chose four geoglyph sites in the vicinity of Palpa that had previously been documented in the framework of the same project through a combined field survey and analysis of high resolution aerial images (Lambers 2006). A reference data set was thus available for these sites. As the geoglyphs of Palpa and Nasca are part of a UNESCO World Heritage site, geophysical prospection is the only non-destructive technique of site exploration apart from aerial archaeology, and the only tool to detect and map possible unknown features beneath the lines and trapezoids.

So far, magnetometry has rarely been used for archaeological prospection in South America. As the magnetic inclination in Palpa is less than 15° and the intensity of the total Earth's magnetic field hardly exceeds 24.000 Nanotesla,

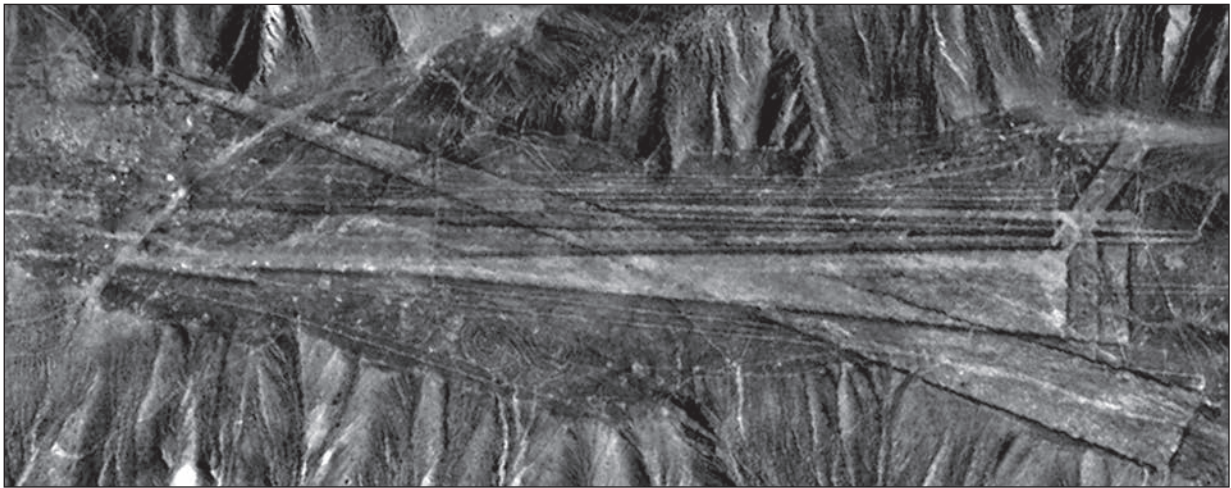

Fig. 1. Orthophoto (resolution: 25 cm) of geoglyphs on site PAP 51A north of Palpa. The complex is composed of lines, spirals and trapezoids constructed over several centuries. Orthoimage courtesy of Institute of Geodesy and Photogrammetry, ETH Zurich.

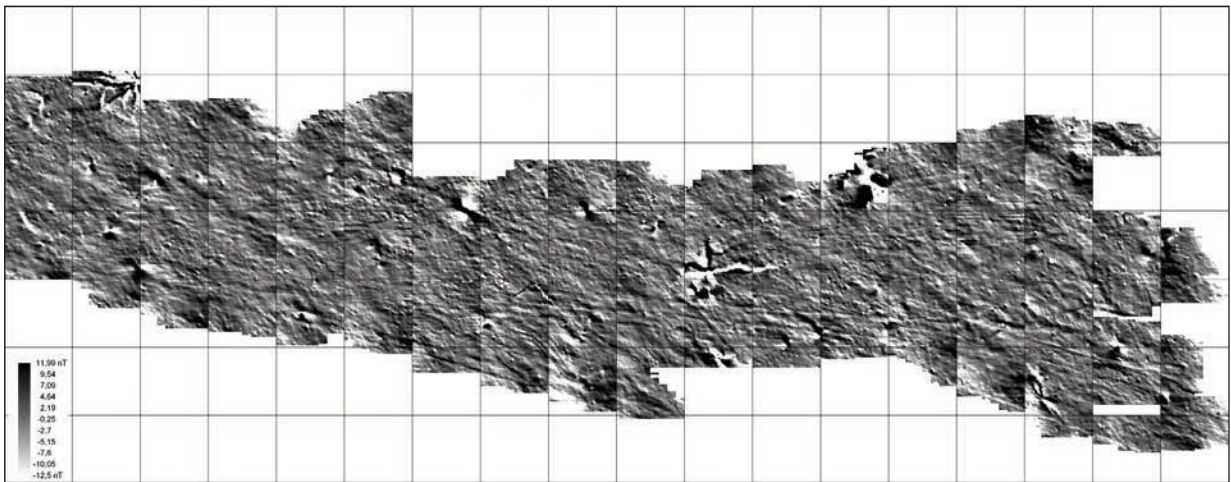

Fig. 2. Magnetogram of geoglyphs on site PAP 51A north of Palpa. Smartmag SM4G - Special in duo-sensor configuration, total field mode. Earth's magnetic field ca. 24 000 Nanotesla, dynamics +/-12.00 nT in 256 grey values from black to white, grid size 40x40 m, sampling density 50x12.5 cm, interpolated by Graduated Shade view based technique.

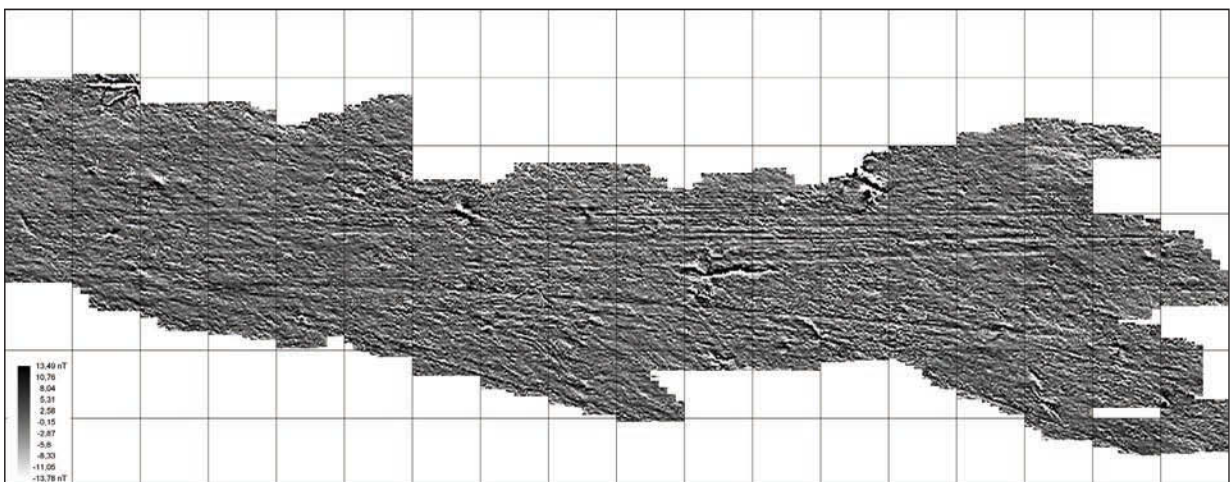

Fig. 3. Magnetogram of geoglyphs on site PAP 51A north of Palpa. Smartmag SM4G - Special in duo-sensor configuration, horizontal gradiometer mode. Earth's magnetic field ca. 24 000 Nanotesla, dynamics +/-13.00 nT in 256 grey values from black to white, grid size 40x40 m, sampling density 100x12.5 cm, interpolated by Graduated Shade view based technique

the highly sensitive total field caesium magnetometer (Scintrex Smartmag SM 4G-Special) to be used during fieldwork needed to be adapted to these conditions. In addition, geochemical processes forming iron oxides in soil, which usually cause clear magnetic anomalies, could not be expected because of the lack of precipitation. On the contrary, due to the flat inclination of the Earth's magnetic field, simple anomalies created more complicated patterns, which were difficult to interpret. To overcome this problem and to enhance the visibility of magnetic data, two sensors were arranged for the first time in a horizontal gradiometer configuration. The application of the magnetometer in such an arrangement, in combination with magnetic total field data, allowed to enhance the visibility of archaeological features in a region close to the magnetic equator. This enabled us to trace old lineal geoglyphs that had been obliterated during the construction of the larger trapezoids on the same site even in Nasca times.

A wooden frame, on which the probes were fixed, ensured a constant distance between magnetometer probes and topsoil. In this configuration two sensors were carried over the site in a zigzag mode, 30 cm above the ground. The sampling speed of the magnetometer (10 readings per second) allowed a 40 m profile of the grid (40x40 m) to be measured in less than 30 seconds. A band pass filter in the hardware of the magnetometer processor was used to eliminate the natural micro-pulsations of the Earth's magnetic field. The slower changes in the daily variation of the geomagnetic field were reduced to the mean value of the 40 m sampling profile and alternatively to the mean value of all data of a 40 m grid (Fassbinder/Irlinger 1999). For data processing the magnetometer readings were imported to Geoplot 3.00 (Geoscan Research) and Surfer (Golden Software) and converted into greyscale values ranging from 0 = white to 255 = black. The horizontal gradient was processed by ArcheoSurveyor (DW Consulting).

Here we report the results of magnetic prospection on four large trapezoids on the pampas to the north, east, and south of Palpa. The magnetograms of the total field measurements are dominated by remanent magnetization of lightning strikes, which clearly demonstrate a climate change in the past (Eitel et al. 2005; Mächtle et al. 2006). As far as archaeological features are concerned, the most important result is the detection of a series of old lineal geoglyphs beneath trapezoids in large geoglyph complexes. Most of these complexes were in use during several centuries and grew considerably over time (Lambers 2006). New geoglyphs were frequently added and existing ones enlarged or remodelled. In this process, large trapezoids often covered older lines. During their construction the stones of the desert pavement between the existing lines were removed, rendering the older lines invisible on the surface. The magnetograms clearly revealed the course of several old lines on all four investigated sites.

The lineal geoglyphs are visible in the magnetograms due to their heavily compacted surface, which was caused by people frequently walking over them in the course of ritual activity taking place on geoglyph sites (Lambers 2006). This compaction destroyed the vesicular horizon of the exposed loess sediment. In contrast, the large trapezoids constructed later did not confine movement of people over them, so their surface is generally less compacted. This is why the older lines are visible in the magnetogram even though their cleared surface resembles that of the trapezoids.

Apart from the geoglyphs, there was no indication at any of the four sites of the presence of archaeological features not related to the geoglyphs, nor had they been used for habitation. Thus, from an archaeological point of view, it seemed unlikely to find any buried archaeological remains predating the construction of the geoglyphs. However, the magnetic measurements showed anomalies that may be interpreted as traces of buildings, postholes, pits or other man-made structures. The relation of these possible structures to the geoglyphs remains to be investigated.

Without destruction and excavation, magnetometry has thus proven to be a powerful archaeological method for studying geoglyph stratigraphy. These findings not only shed new light on the development of large geoglyph complexes over time but also on the understanding of the Paracas and Nasca cultures and the history of the region in general. Magnetometry is thus a welcome tool for Nasca archaeology to confront unsound theories proposed by amateur archaeologists with scientific data.

REFERENCES

- Aveni 1990* A. F. Aveni (ed.): The lines of Nazca. Memoirs of the American Philosophical Society 183, Philadelphia 1990.
- Eitel et al. 2005* B. Eitel et al.: Geoarchaeological evidence from desert loess in the Nazca-Palpa region, southern Peru: paleoenvironmental changes and their impact on pre-Columbian cultures. *Archaeometry* 47/1, 2005, 137-158.
- Fassbinder/Reindel 2005* J. Fassbinder/M. Reindel: Magnetometer prospection as research for pre-Spanish cultures at Nasca and Palpa, Peru. 6th International Conference on Archaeological Prospection, Roma 2005, 6-8.
- Fassbinder/Irlinger 1999* J. W. E. Fassbinder/W. Irlinger: Combining magnetometry and archaeological interpretation: a square enclosure in Bavaria. *Archaeological Prospection, Arbeitshefte des Bayerischen Landesamtes für Denkmalpflege* 108, Munich 1999, 95-99.
- Lambers 2006* K. Lambers: The geoglyphs of Palpa, Peru: documentation, analysis, and interpretation. *Forschungen zur Archäologie Aussereuropäischer Kulturen* 2. Aichwald 2006.
- Mächtle et al. 2006* B. Mächtle et al.: Holocene environmental changes in the northern Atacama desert, southern Peru (14°30'S) and their impact on the rise and fall of pre-Columbian cultures. *Zeitschrift für Geomorphologie, supplement* 142, 2006, 47-62.

Reindel/Grün 2006

M. Reindel/A. Grün: The Nasca-Palpa Project: a cooperative approach of photogrammetry, archaeology and archaeometry. In: E. Baltsavias et al. (eds.), *Recording, modeling and visualization of cultural heritage*. London 2006, 21-32.

Tomasz Gorka
Bavarian State Dept. of Monuments and Sites
Archaeological Prospection
Postfach 100203, D-80076 Munich, Germany
Ludwig Maximilian University, Dept. of Earth
and Environmental Sciences
Section Geophysics, Theresienstrasse 41
D-80333 Munich, Germany
tomasz.gorka@geophysik.uni-muenchen.de

Jörg W.E. Fassbinder
Bavarian State Dept. of Monuments and Sites
Archaeological Prospection
Postfach 100203
D-80076 Munich, Germany
joerg.fassbinder@blfd.bayern.de

Karsten Lambers
German Archaeological Institute, KAAK
Endenicher Str. 41, D-53115 Bonn, Germany
lambers.kaak@gmx.de

MAPPING THE CHICKASAW WITH INTEGRATED MAGNETIC GEOPHYSICS

Bryan S. Haley - Jay K. Johnson

Key words: geophysics, magnetics, electromagnetics, magnetic susceptibility, North America

Geophysical techniques have been very productive on late Prehistoric sites in the southeastern United States. Specifically, features exhibiting thermoremanent magnetism, such as burned wattle and daub structures, can produce dramatic responses with the magnetic gradiometer. However, sites containing more ephemeral features, including historic Native American villages, offer a more challenging target for geophysical survey. Research was conducted by the University of Mississippi on protohistoric and historic Chickasaw sites to determine the utility of integrated geophysical survey on these targets.

Study Area

The homeland of the Chickasaw is located near the city of Tupelo in northeastern Mississippi. Chickasaw sites are characterized by a small to moderate number of dwellings, associated burials, and large midden pits containing high densities of ceramics, lithics, and trade material. The latter type of feature was typically in use for a relatively short period of time and is particularly useful for determining the chronology of the sites. Surface features are rarely visible to guide archaeological investigations. The Chickasaw area is under increasing threat by development projects due to substantial population growth. Geophysical survey, when included in a multistage research design, has the potential to efficiently determine the extent of archaeological resources on endangered Chickasaw sites.

Three sites were investigated as part of the research: Slope (22LE1004), Reed Branch III (22LE678), and Weilmon (22LE613). The sites are situated on low ridges overlooking floodplains, the most common location for Chickasaw sites of this time period. Since all three sites faced some impact from modern highway or subdivision development activities, rapid and efficient investigations of the sites were required. Such investigations are typical of cultural resource management projects, which make up the bulk of the archaeological research in the United States.

Methods

The University of Mississippi Center for Archaeological Research owns and operates a number of geophysical instruments, including a Geoscan FM36 fluxgate gradiometer and a Geonics EM38B electromagnetic induction meter. Magnetic gradiometer has proven itself not only for targets exhibiting thermoremanent magnetism, but also organic-filled midden pits with enhanced levels of magnetic susceptibility. More recently, we have begun to realize the effectiveness of the in-phase (magnetic susceptibility) recording mode of the EM38B for delineating pit features. Furthermore, since the magnetic gradiometer responds to both remnant and induced magnetism and in-phase electromagnetics respond to induced magnetism, a comparison of the two may allow a qualitative assessment of the two magnetic properties. An integrated approach such as this may lead to better discrimination between various types of magnetic targets.

Results

Investigations at each site began with traditional archaeological techniques consisting of either systematic surface collection or shovel testing. In two cases, Slope and Reed Branch III, artifacts encountered were modest. In the third case, Weilmon, artifact numbers were high, but their distribution was fairly uniform and did little to guide the

placement of test excavation. In all three cases, traditional archaeological methods were of little help in evaluating the likelihood intact cultural deposits.

The geophysical survey results at these sites contain several anomalies which are unique to one or the other of the instruments. However, similar anomalies were found in both the magnetic gradiometer and in-phase electromagnetic induction data. The anomalies were high amplitude, ranged from about 2 meters to 4 meters in diameter, and were roughly circular in shape (Fig. 1, 2, 3). In one case (Reed Branch III), a dipole was superimposed on the high amplitude monopole in the magnetic gradient data. Due to their appearance in multiple data sets, these were chosen for additional subsurface investigation.

Excavation revealed that the anomalies were caused by the large midden pits typical of Chickasaw village sites. The features exhibited the common characteristic dark, organic-rich soil and high densities of Chickasaw artefacts. In several cases, metal European trade items were encountered. The dipole in the pit at Reed Branch was caused by a hoe of Spanish origin.

Discussion

The in-phase component of electromagnetic data has often been overlooked in North American archaeological geophysics. With the development of the EM38B, which simultaneously collects quadrature and in-phase components, there is no time penalty for collecting both data sets. As we understand the response of the in-phase com-

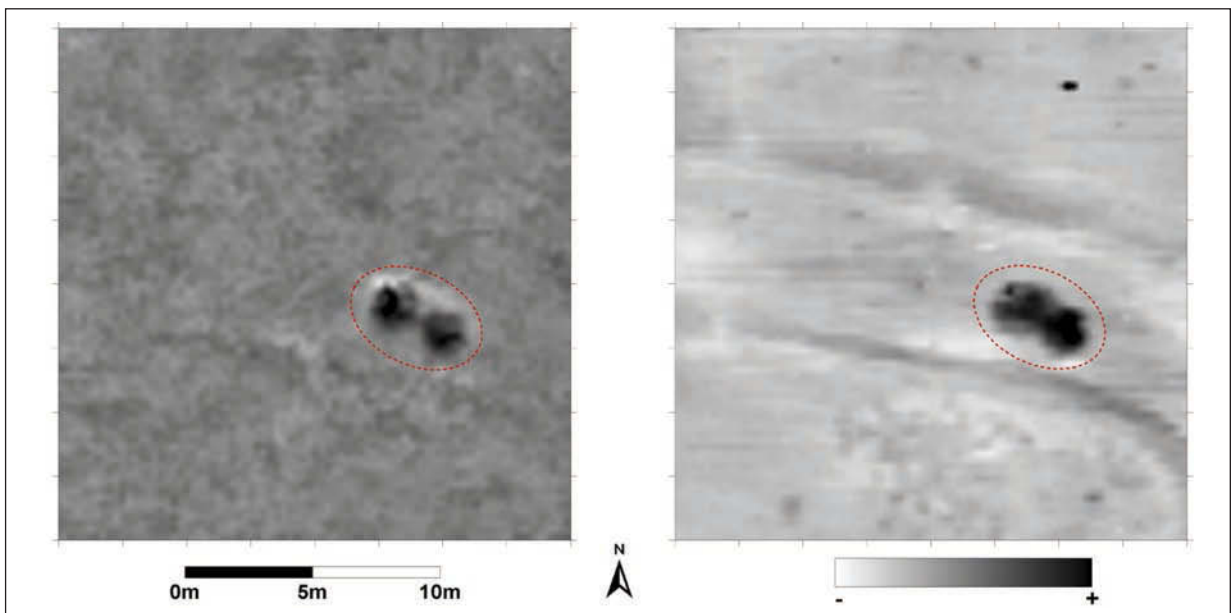

Fig. 1. Results from magnetic gradiometer (left) and the in-phase component of the electromagnetic induction (right) for Slope.

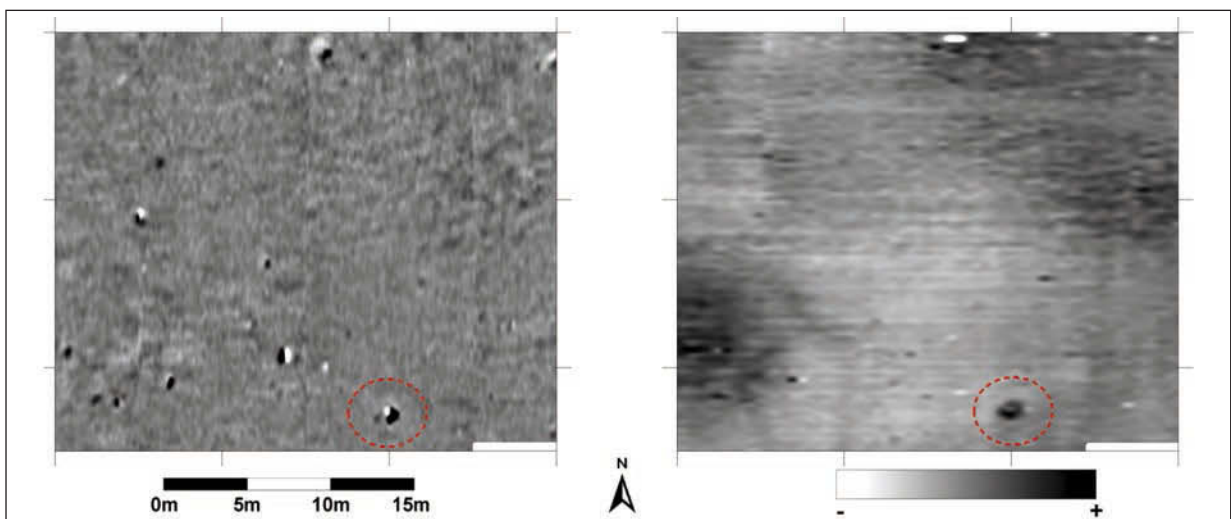

Fig. 2. Results from magnetic gradiometer (left) and the in-phase component of electromagnetic induction (right) for Reed Branch III.

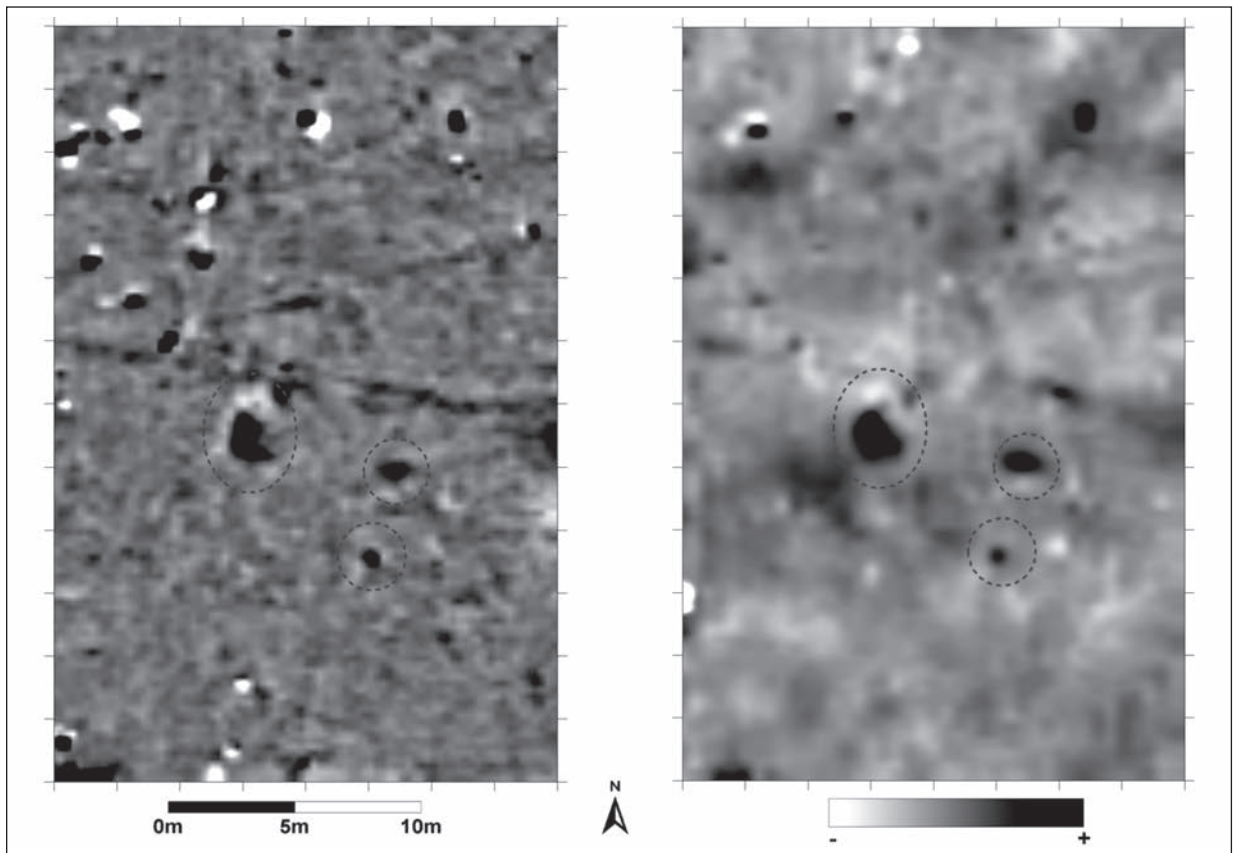

Fig. 3. Results from magnetic gradiometer (left) and the in-phase component of the electromagnetic induction (right) for Weilmom.

ponent to various archaeological features, its utility can be better assessed. Our results indicate that it can be quite productive, even rivaling the magnetic gradiometer in anomaly contrast and accuracy of shape.

More importantly, additional information can be gained by a systemic comparison of the two types of magnetic data. In this case, Chickasaw midden pits appear to be distinguishable due to a unique relationship between magnetic gradient and magnetic susceptibility. A statistical comparison of the data layers indicates that it is possible to develop a signature for these anomalies that can aid their interpretation.

REFERENCES

- Aitken 1961* M. J. Aitken: Physics and Archaeology. New York 1961.
Clark 1990 A. Clark: Seeing Beneath the Soil, Prospecting Methods in Archaeology, 1990.
Johnson 2000 J. K. Johnson: The Chickasaws. In: Indians of the Greater Southeast. Historical Archaeology and Ethnohistory. G. McEwan (ed.). Gainesville 2000, 85-121.
Johnson 2006 Johnson, J. K. (ed.): Remote Sensing in Archaeology: An Explicitly North American Perspective. Tuscaloosa 2006.
Johnson/Stallings/Ross-Stallings/Clay/Jones 2000 J. K. Johnson/R. Stallings/N. Ross-Stallings/R. Berle Clay/V. Stephen Jones: Remote Sensing and Ground Truthing at the Hollywood mounds Site in Tunica County, Mississippi. Center for Archaeological Research. Jackson, Mississippi 2000.
Reynolds 1996 J. M. Reynolds: An Introduction to Applied and Environment Geophysics. New York 1996.

Bryan S.
Jay K. Johnson

Haley University of Mississippi
309 Leavell Hall, University of Mississippi, University,
MS 38677, USA
bshaley@olemiss.edu
sajay@olemiss.edu

THE PRESENT STATE OF NON-DESTRUCTIVE ARCHAEOLOGICAL SURVEYING IN MORAVIA

Vladimír Hašek - Jaromír Kovárník - Jaroslav Peška

Key words: magnetic prospection, aerial photography, Moravia

Non-destructive archaeological surveying in Moravia has one of the longest traditions within the countries of Central and Eastern Europe. The beginnings of systematic use of archaeogeophysical surveying reach back to the middle of 1970's and aerial archaeological surveys to the turn of the year 1982/1983.

Non-destructive archaeological surveying in Moravia includes, besides geophysical methods, the use of aerial reconnaissance and documentation of archaeological monuments:

1. Archaeogeophysical surveying: magnetometric measuring (cesium and proton magnetometer), soil radar, DEMP method etc.
2. Follow-up checking by terrain surface archaeological research and test-pits.
3. The final phase in positive archaeological sites discovered is overall pre-research.

In the past period we focused especially on non-destructive surveying of the routes of important international and inland roads planned in the areas of building of large-scale premises (of production, storage, sale etc.), on verifying of archaeological monuments detected during aerial surveys of selected archaeological monuments etc.

Ad 1

The all-European transport network will comprise Trans-European transport routes of Western Europe (TEN), Central and Eastern Europe, European countries of the former Soviet Union and partners of the EU around the Mediterranean Sea. In view of new countries that joined the EU in 2004, the process TINA is being realized, its purpose being to determine wider scope of necessary measures concerning both extending the routes - European transport networks in these countries, and developing connections among transport routes of individual states.

Motorways that are part of Pan-European corridors IV and VI are ranked to the mainstay network TINA, future extension of the network TEN (corridor IV: Berlin - Dresden - Prague - Brno - Bratislava - Budapest - Thessalonica - Istanbul); multimodal corridor VI (Gdansk/Łódź - Katowice - Bohumín - Ostrava - Brno - Vienna): D 8, D 1 and D 2 in corridor IV: D 5 in branch A of corridor IV, D 1 and D 47 continuation in Polish motorway A 1 in a branch of corridor VI. The project thus deals with quality connection of the national road network to the European road network and the highroad network in the Czech Republic (focusing on Moravia and Silesia) will consist of parts of D 1 motorway Vyškov - Lipník nad Bečvou, D 2, D 47 Lipník nad Bečvou - the border of the CR and PR and of the speedway R 35 Kýlov - Lipník nad Bečvou, R 43, R 46, R 48, R 49 Hulín - the border of the CR and SK and R 55 Břeclav - Hulín, respectively Přerov - Olomouc.

This designed building of road network means huge destructive intervention in the terrain morphology, where it violates, or possibly destroys, probably many archaeological sites. For elimination of this negative impact on archaeological monuments it is necessary, according to current documentation in the form of Territorial Archaeological Studies, made up for individual building projects, gradual realization of a number of rescue excavations of all parts of find spots at risk, which will include permanent, but also temporary occupation of the intended routes, but especially at unfinished segments of motorways D 1 (see Fig. 1), D 3, D 47, respectively also express highways R 35, R 49 and R 55.

Ad 2

Significant activities included complex archaeological surveying, e.g. of the building sites of factory plant Opava in Opava, building sites of shopping centres in Olomouc, Tábor, one-family houses in Olomouc-Neředín etc.

Ad 3

Archaeogeophysical surveys also focused on objects discovered by aerial reconnaissance. Measuring took place in these types of archaeological sites with line and spot anomalies:

- *rondels* from Neolite (Běhařovice, Němčičky, Vedrovice, district of Znojmo; Rašovice, distr. of Vyškov)
- *rondeloids* of early bronze age (Šumice, Troskotovice, distr. of Znojmo, Vlasatice, distr. of Břeclav, Kyjov, distr. of Hodonín)
- *ditch fortifications* of prehistoric age (Hrušovany nad Jevišovkou, distr. of Znojmo; Štibořice, distr. of Břeclav, Čejč, distr. of Hodonín (Fig. 2); Vážany nad Litavou, distr. of Vyškov, Tučapy, distr. of Olomouc)

Ad 4

Archaeogeophysical measuring was also realized in selected archaeological monuments. They are represented primarily by religious architecture. So far we explored:

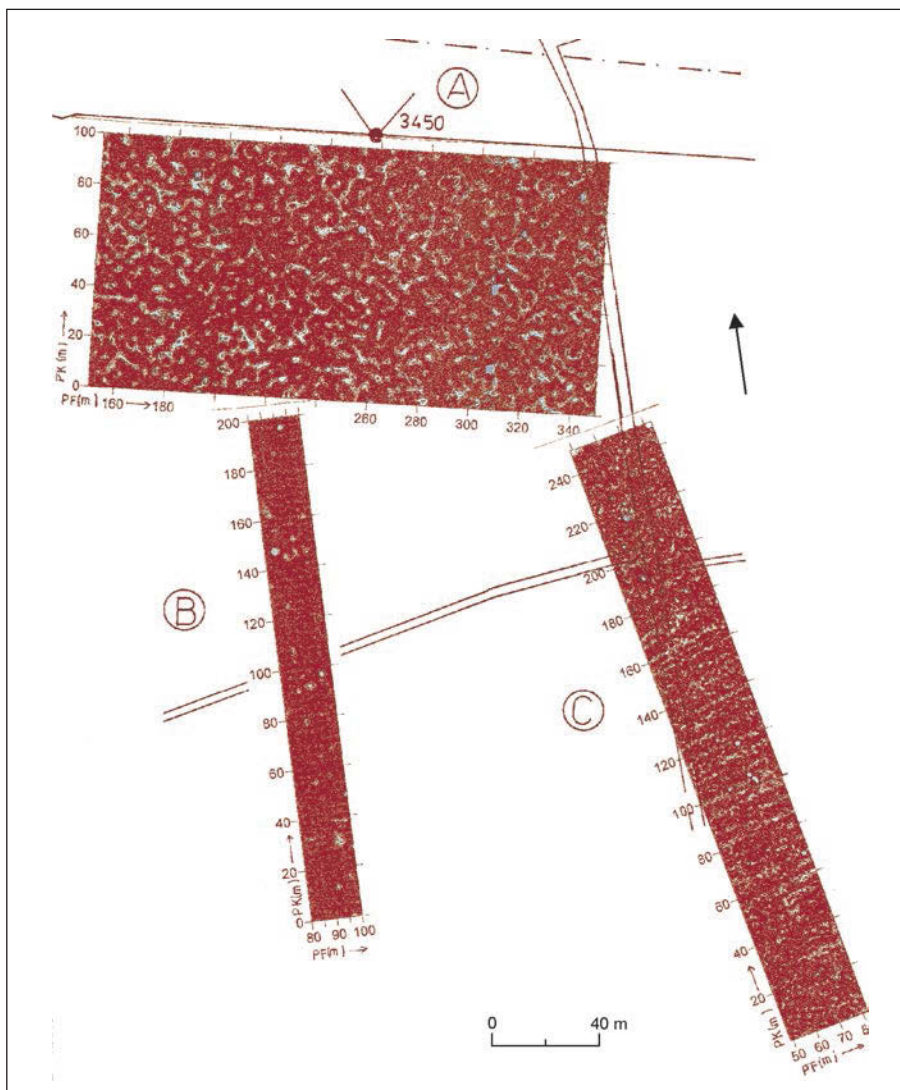

Fig. 1. Stříbrnice, district of Přerov: Shadow map of the gradient of the vector of total geomagnetic intensity (TZ) of the Bell-beaker Culture grave pits.

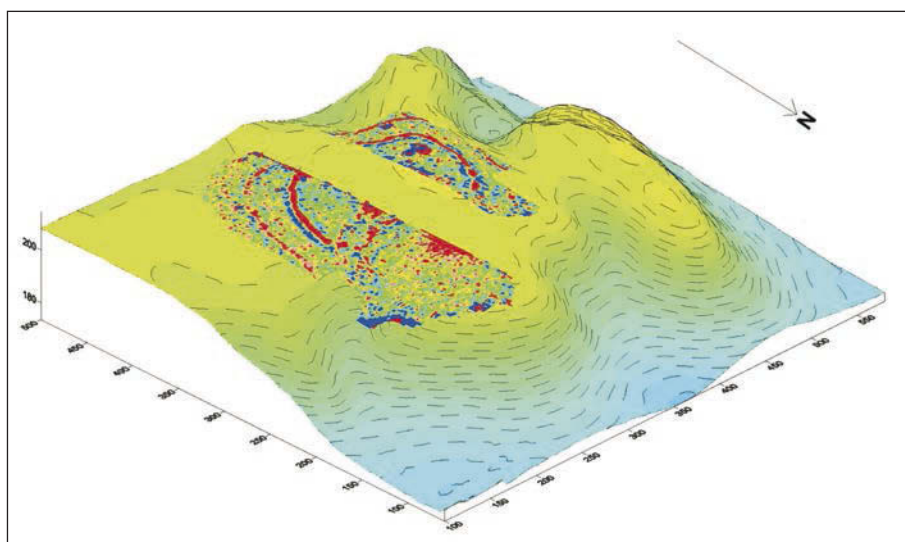

Fig. 2. Čejč, distr. of Hodonín: Shadow map of the gradient of the vector of total geomagnetic intensity (TZ) of a fence with four arc ditches probably from Únětice culture from the Early Bronze Age.



Fig. 3. Třebíč. Aerial view of the basilica of St. Prokop from Romanesque-Gothic period (around 1240).

- *basilicas with crypts* (Romanesque basilica of St. Wenceslas in Premonstratensian monastery in Znojmo-Louka, basilica of St. Prokop with Romanesque-Gothic crypt in Třebíč (Fig. 3), the synagogue in Tábor)
- *convents and convent churches* (the former Minorite convent in Znojmo, a part of Premonstratensian convent in Znojmo-Louka, the church of Premonstratensian convent in Želiva)
- *city and cemetery churches* (the church of St. Thomas in Brno, the church of St. Nicholas in Znojmo with ground plan of an older, probably Romanesque church, the church of St. John the Baptist at T. G. Masaryk Square in Znojmo, St. Martin in Blansko, the Holy Trinity in Hostinné etc.

Thanks to combining of all above-mentioned surveying methods we obtained very good results in archaeological practice itself, especially in the area of archaeological preservation of monuments.

Vladimír Hašek
Geopek, s.r.o.
Ječná 29a
621 00 Brno, Czech Republic
hasek@geopek.cz

Jaromír Kovárník
South Moravian Museum in Znojmo
Přemyslovců 8
669 45 Znojmo, Czech Republic
kovarnik@znojmu.cz

Jaroslav Peška
Archaeological Centre in Olomouc
Ulice Bratří Wolfů 16
779 00 Olomouc, Czech Republic
peska@ac-olomouc.cz

HIGH-RESOLUTION INTEGRATED SURVEYS IN THE ARCHAEOLOGICAL SITE OF ST. JOHN LATERAN BASILICA (ROMA, ITALY)

Ian Haynes - Vince Gaffney - Michael Lobb - Margaret Watters - Steve Wilkes -
Salvatore Piro - D. Zamuner

Key words: GPR, 3D laser scanner, HP-Vista, St. John Lateran Basilica, Rome

St. John Lateran Basilica has been the focus of intense antiquarian and archaeological interest since 1730s. In recent years it has benefited particularly from scholarly investigation by Prof. P. Liverani (University of Florence, Consultant to the Vatican Museums). Liverani's work at the Lateran site has focussed on understanding the extensive excavations beneath the modern basilica. Analysis of the structures within the excavated area has suffered from a lack of proper documentation by previous studies of the complex, lack of a reliable plan and lack of systematic analysis. The one area that is now receiving intensive attention is the famous Baptistry, the first in western Christendom.

The aim of this project is to undertake an intensive survey of the entire complex, integrating standing buildings, excavated structures and sub-surface features. The use of detailed survey techniques and 3D scanning will facilitate the interaction of different specialists and materials.

To enhance the knowledge of the subsoil of St. John Lateran Basilica (Rome), and to locate the unknown buried structures below the actual studied levels, a scientific collaboration between Birkbeck College (University of London), HP VISTA Centre (University of Birmingham) and the Institute of Technologies Applied to Cultural Heritage (ITABC-C.N.R.) has been developed, starting in 2006 and being still in progress.

A series of tests on the site, which demonstrate the potential of various methods for this form of analysis, fully assess the cost implications of the study and win support from local collaborations, were developed during October 2006.

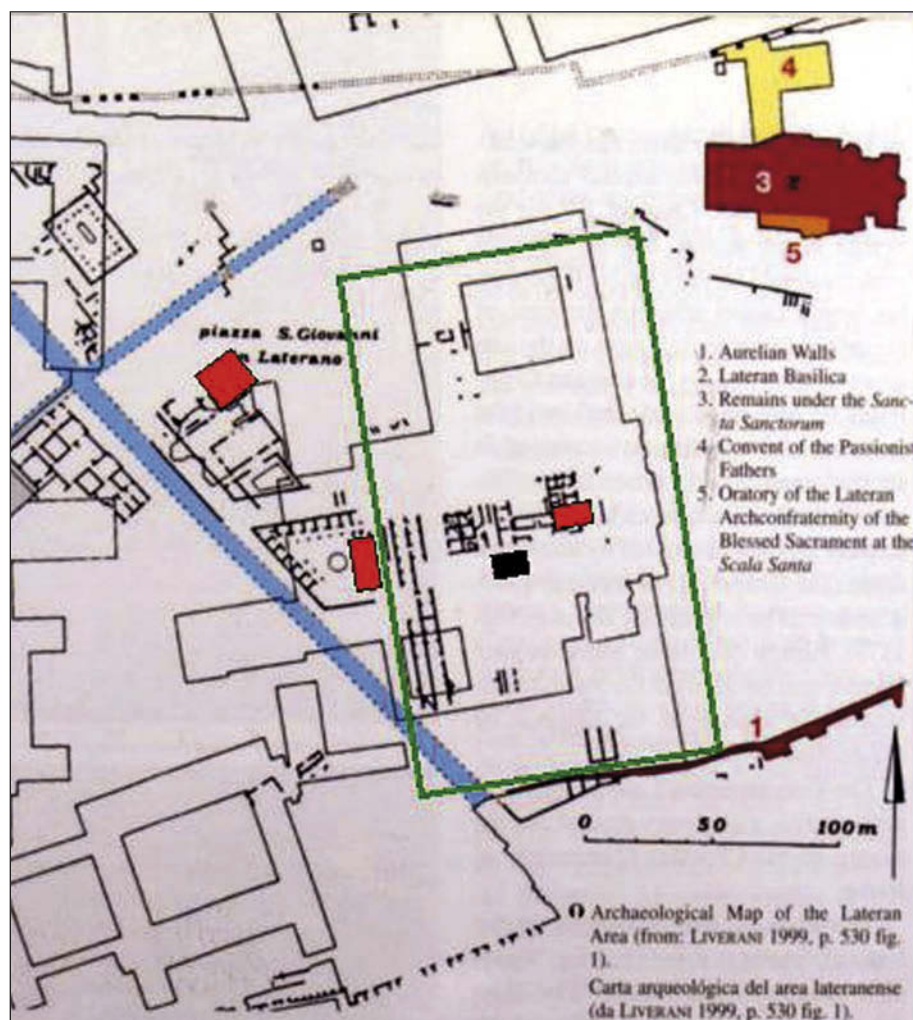

Fig. 1. Archaeological map of the St. John Lateran site (courtesy of Liverani).



Fig. 2. Laser scanner survey. 3D model of the Nymphaeum complex.

3D Scanning Survey & Modelling

Interest in the development of the Lateran complex spans many disciplines, from archaeology and art history to engineering and fabric structure. Each seeks to record and investigate often differing aspects of the same Lateran substructure. Melding these interests to avoid constant resurveying activity requires a methodology that can best address as many potential survey requirements as possible. To this end the primary objective of the laser scanning survey was to illustrate the potential for provision of a spatially accurate, precisely detailed, 3D representation of the subsurface structure. This was then to enable dissemination of a 3D surface model among the many, and disparate, interested researchers that still reflected all the intricacies of the Lateran subsurface complex.

A Leica HDS 3000 and Minolta VI-900 were utilised for the initial survey with the main targets in the Nymphaeum area of the complex. Data was collected with the HDS from five different scanner positions, at a point spacing of at least 5mm. Point spacing was dropped to 1mm if the initial scan was deemed to be missing the required level of surface texture. A series of high reflectance survey targets were recorded to enable the 'stitching' of the separate scanner positions to form a single, unified, 'scan world'. Point clouds were then processed to produce detailed CAD floor plans and elevations along with detailed solid surface meshes. The resulting data was then integrated with the subsurface features identified by GPR survey (below) to produce a spatially accurate, precise, full 3D model of the Nymphaeum complex, Fig. 2.

GPR survey

For the measurements a GPR Sir 3000 (GSSI), equipped with a 400, 500 and 900 MHz bistatic antenna with constant offset were employed. Some signal processing and representation techniques have been used for data elaboration and interpretation.

GPR surveys were performed, employing the SIR 3000 (GSSI) to survey the selected area of the bath complex associated with the later Baptistery, the "market" within the archaeological excavations and the area to the North of Baptistery Fig. 1.

The horizontal spacing between parallel profiles at the site was 0.5 m, employing the two indicated antennas. Radar reflections along the transects were recorded continuously, with different length, across the ground at 40 scan s^{-1} ; horizontal stacking was set to 3 scans. Along each profile markers were spaced every 1 m to provide spatial reference. All radar reflections within the 50 ns (with 400 and 500 MHz antenna) and 30 ns (for 900 MHz antenna) (two-way-travel time) time window were recorded digitally in the field as 16 bit data and 512 samples per radar scans.

With the aim of obtaining a planimetric vision of all possible anomalous bodies the time-slice representation technique was applied using all field profiles (Goodman *et al.* 1995; Piro *et al.* 2003). Time-slices are calculated by creating 2-D horizontal contour maps of the averaged absolute value of the wave amplitude from a specified time value across parallel profiles. Time slice data sets were generated by spatially averaging the squared wave amplitudes of radar reflections in the horizontal as well as the vertical. The data were gridded using a Kriging algorithm that included a search of all data within a 1.0 m radius of the desired point to be interpolated on the grid. Filter was used to remove the background reflections.

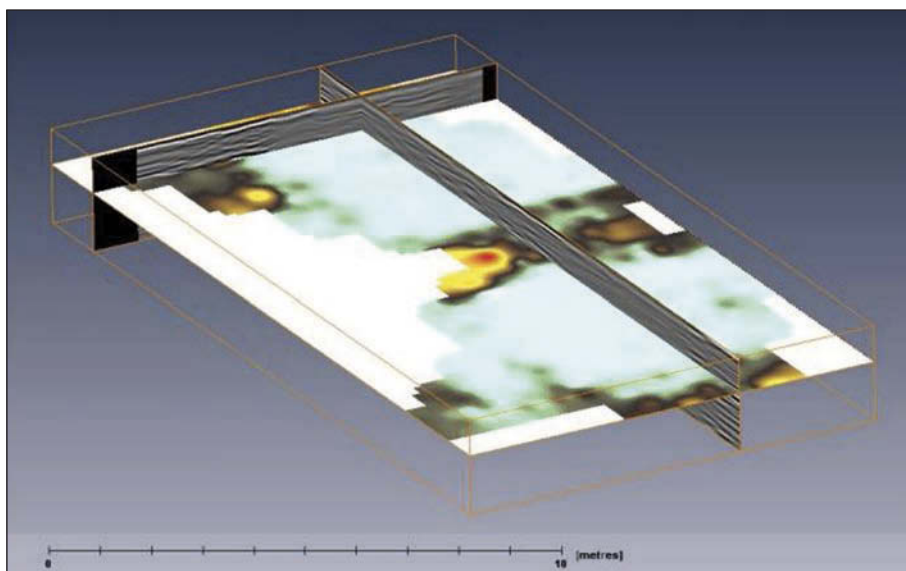

Fig. 3. St. John Lateran site - *Macellum* Area. Example of GPR time-slice.

In Fig. 3 the time-slice (in the time window 18-20 ns twt) for the investigated *Macellum* area is shown. On this map the individuated anomalies are better visible.

This project is still in progress and new surveys, employing integrated geophysical methods, are planned for the next year.

REFERENCES

Goodman/Nishimura/Rogers 1995

D. Goodman/Y. Nishimura/J. D. Rogers: GPR time-slice in archaeological prospection. *Archaeological Prospection* 2, 1995, 85-89.

Piro/Goodman/Nishimura 2003

S. Piro/D. Goodman/Y. Nishimura: The study and characterisation of Emperor Traiano's Villa (Altopiani di Arcinazzo, Roma) using high-resolution integrated geophysical surveys. *Archaeological Prospection* 10, 2003, 1-25.

Ian Haynes

School of History, Classics and Archaeology
Birkbeck College, University of London
Malet Street, London
WC1E 7HX, United Kingdom
i.haynes@bbk.ac.uk

Salvatore Piro
D. Zamuner

Institute for Technologies Applied to Cultural Heritage ITABC-CNR
Research Area Roma1 - National Research Council of Italy
P.O. Box 10 - 00016 Monterotondo Scalo, Roma, Italy
Salvatore.piro@itabc.cnr.it

Vince Gaffney
Michael Lobb
Margaret Watters
Steve Wilkes

HP VISTA Centre, University of Birmingham
Edgbaston, Birmingham B15 2TT, United Kingdom
v.l.gaffney@bham.ac.uk
IAA-LobbM@adf.bham.ac.uk
meg_watters@hotmail.com
S.M.Wilkes@bham.ac.uk

GEOPHYSICAL SURVEYING IN EGYPT: PERIODIC REPORT FOR 2005-2006

Tomasz Herbich

Key words: Egypt, magnetic prospecting, resistivity prospecting

Magnetic scanning as a useful method for tracing the layout of archaeological sites has been winning followers in Egypt lately. This translates into the number of geophysical surveys that are being commissioned. The present article concerns the author's work in 2005 and 2006, previous reports having been presented at conferences in Vienna (*Herbich 2001*), Cracow (*Herbich 2003*) and Rome (*Herbich 2005*).

In 2005-2006, ongoing projects at Tell Daba, Buto, Bawit, Marea, Tell Balamun, Fayum Oasis and Farkha were continued. New projects included investigations at Baharija, Gurob, Karnak, Kellia, Wadi Natrun, Memphis, Napta Playa, Pelusium, Sohag, Tell Daba, Tell Borg and Tell Herr. If not mentioned otherwise, the method used was magnetic prospecting, occasionally supplemented by resistivity.

The purpose of the research at Napta Playa (Western Desert) was to determine the makeup of the ground under concentrations of Neolithic megaliths. Resistivity research demonstrated that the concentrations were localized above monadrocks, which served as a kind of foundation. Investigations on the northeastern side of Karanis Lake in Fayum Oasis in the region of Neolithic settlement (Kom K and Kom W, investigated in the 1930s) revealed traces of occupation (pits, fireplaces) and determined the extent of the sites.

Prospection in Gurob (Fayum) was supposed to complete the plan of the town from the Middle and New Kingdoms prepared by F. Petrie's expedition in the early 20th century. The extent of site destruction, as well as low susceptibility of the material used in brick production resulted in a geophysical survey providing little new data. What the survey did reveal were fairly extensive traces of industrial manufacturing.

Research in Tell Daba in the eastern Delta (carried out in association with Christian Schweitzer) uncovered an entire palace and a temple complex from the Hyksos period (Fig. 1), and led to the discovery of a town from the Middle Kingdom, which had an orthogonal plan, as well as of urban architecture dated to New Kingdom and Late Period. The total area surveyed amounts to 90 ha.

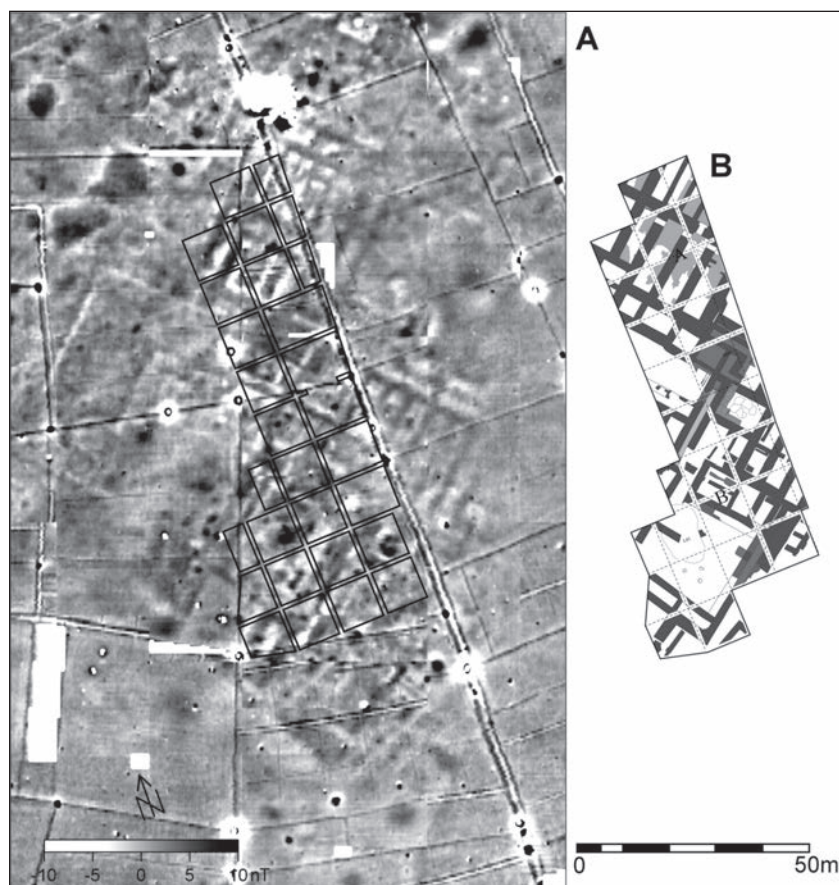

Fig. 1. Tell Daba, area F/II. A - magnetic map of palatial complex from the Hyksos period. Geoscan Research FM36. Sampling grid 0.25 by 0.50 m interpolated to 0.25 by 0.25 m. Outlined areas correspond to trenches. B - results of the excavation of the Austrian Archaeological Institute (M. Bietak, I. Forstner-Müller).

Prospection in Karnak (Upper Egypt) did not reveal the remains of the temple of Ahenaton, as expected, but it did trace the northern section of the temenos wall around the temple from the Tuthmoside period.

At Tell el Borg (Northern Sinai) the survey concentrated on the settlement around the New Kingdom forts. Sections of a ditch surrounding the Eighteenth-Dynasty fort were discovered, and the extent of the necropolis examined. Destruction of the settlement itself during recent Israeli occupation turned geophysical methods useless in this case.

In Memphis (Nile valley) the area neighboring with the palace of Apres was investigated. Unfortunately, the topmost layers had been disturbed for the most part by excavations and plundering. Some remains of urban architecture turned up as anomalies on geophysical maps. Fragmentary preservation of the structures precluded identification of either function or date. Only archaeological excavations can redress the situation in this case.

Buto in the northwestern Delta contained a complex of mudbrick structures of unidentified function, located in the northwestern part of the site. Archaeological excavations of some of these structures dated them to the Late Period. In the southern end there were two sections of a wall of unknown function (temenos?); the wall, which was 10 m thick, proved to originate from the Ptolemaic period. The total length of all discovered sections of the wall runs close to 600 m.

Geophysical surveying in Balamun (northeastern Delta) covered 60% of the Late Period temple complex (Fig. 2). Production centers were located behind the known structures, and previously unknown and functionally unidentified features were located in association with the excavated temples. One such feature, for instance, is a stone building in front of Nectanebo's temple and an additional pylon before the temple of Psamtik. Moreover, an unknown temple of earlier date was recorded. The plan of the fort was filled in, and a gate was discovered in the southeastern side of the temenos.

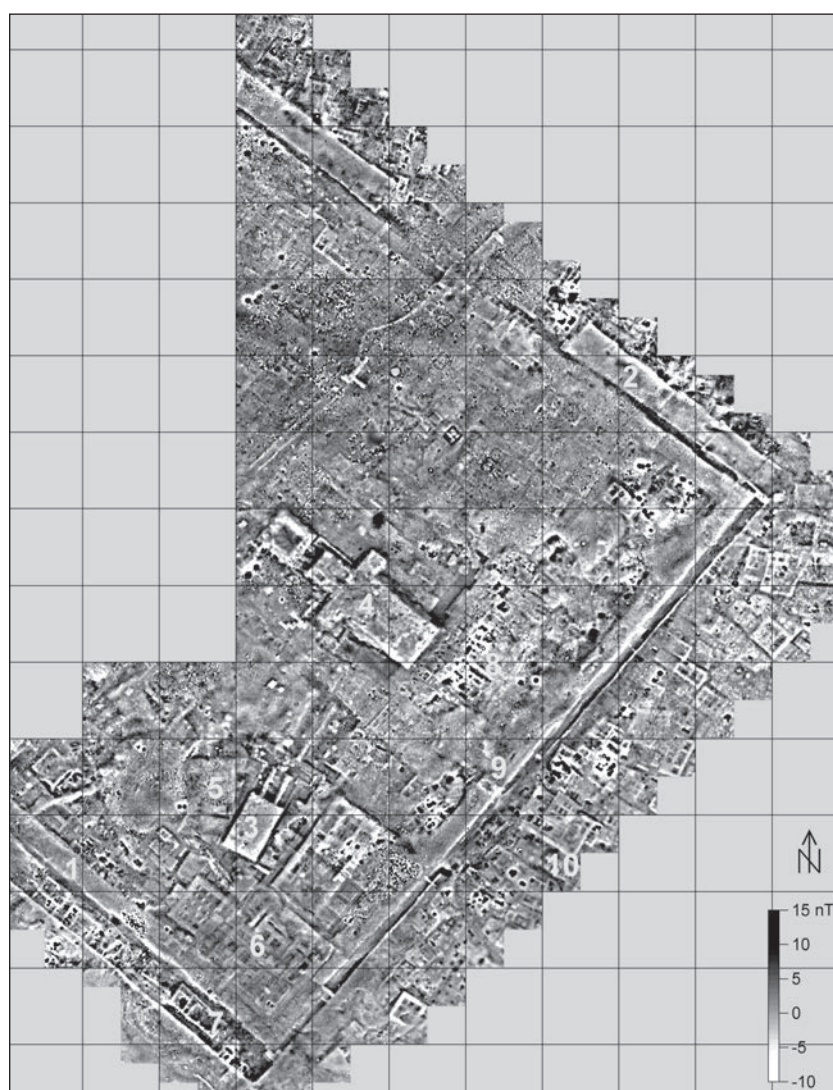

Fig. 2. Tell Balamun. Magnetic map of the temple area. Geoscan Research FM36. Sampling grid 0.25 by 0.50 m interpolated to 0.25 by 0.25 m. Grid lines every 40 m. 1 - Enclosure wall of the 26th Dynasty; 2 - enclosure wall of the 30th Dynasty; 3 - temple of Psamtik I; 4 - temple of Nectanebo I; 5 - unknown temple; 6 - fort with annexes; 7, 8 - industrial areas; 9 - gate in the wall of the 26th Dynasty; 10 - houses from the Saitic period.

In Marea (Mediterranean coast) a complete magnetic map was prepared of a Roman industrial center investigated by a French team on a promontory in the eastern part of the town. The survey also helped to trace the course of the road connecting the promontory with the rest of the town.

At Bîr el-Farachîn in Bahariyah Oasis, the prospection was a means of updating the plan of a Roman-period architectural complex discovered as a result of analysing satellite photography. A set of furnaces was also discovered. At Qasr 'Allam, architecture accompanying a Late-Period platform was discovered.

In Fayum Oasis, research was carried out on two sites. At Karanis the objective was to trace the southwestern borders of the site; a few furnaces were also discovered. Investigations at Qaret Rusas, where no archaeological digging had ever been done, determined the extent of a town which was known mainly on the basis of collected surface archaeological material. The run of the main streets was reconstructed and the approximate orientation of a number of buildings established.

The survey at Pelusium (North Sinai, Late Roman/Early Christian period) covered the area between the theater and the northern edge of the town (Fig. 3). Magnetic scanning recorded the street network and isolated dried mud-brick architecture from the prevalent red-brick architecture on the site. Resistivity measurements helped to clarify

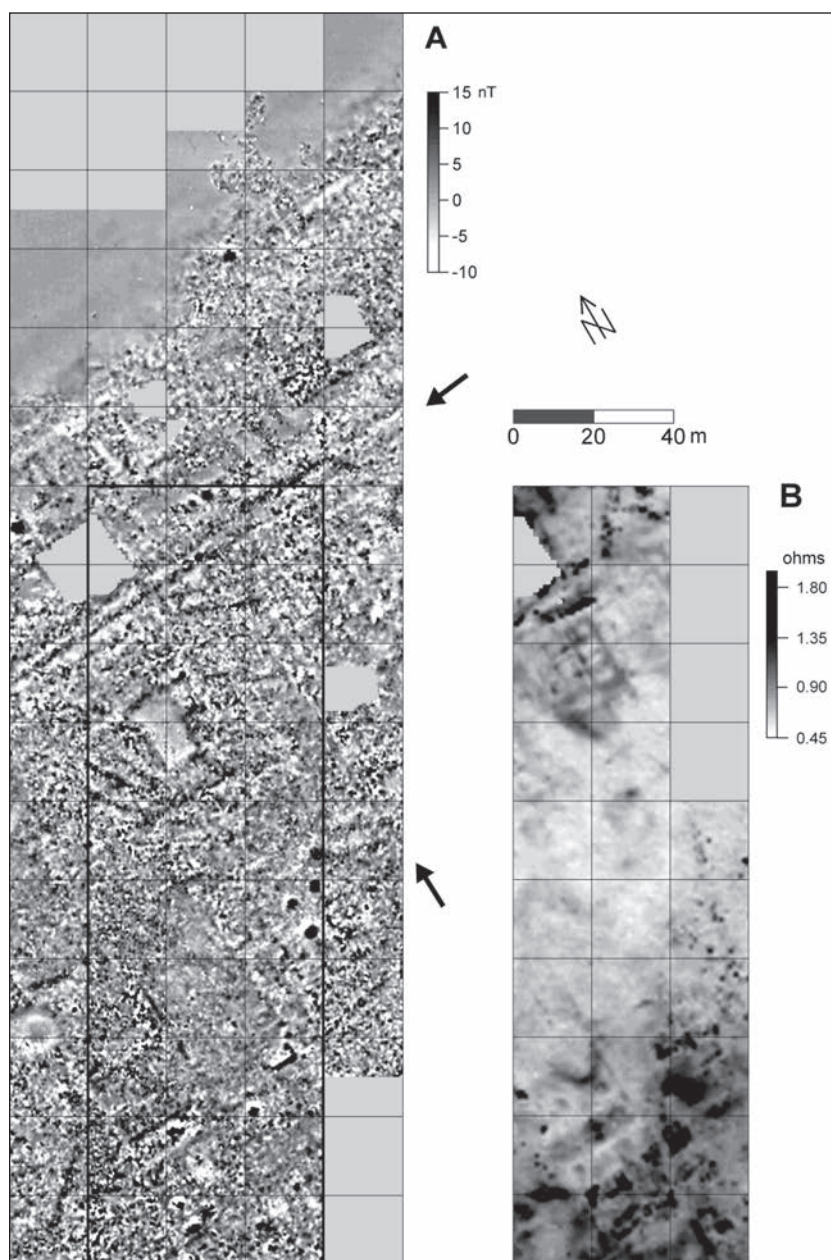

Fig. 3. Pelusium. A. Magnetic map. Geoscan Research FM36. Sampling grid 0.25 by 0.50 m interpolated to 0.25 by 0.25 m. Frame marks area covered by the resistivity survey, arrows mark streets. B. Resistivity map. Geoscan Research RM15. Twin probe array; spacing of mobile probes 0.5 m; spacing of remote probes 1.5 m. Sampling grid 0.5x1 m, interpolated to 0.5 m. Low pass filter.

the plan of a number of buildings, and were instrumental in reconstructing the plan of a few others by recording trenches that were left by ghost walls after the foundations had been plundered.

Research at Kellia (in the west Delta) filled in plans of hermitages from the Early Christian period; the plans were drawn from the surface evidence and shallow testing. The method identified very clearly the kitchen and domestic part of the hermitages, mainly due to the presence of furnaces and fireplaces. In a few cases, the known borders of hermitages were revised.

Magnetic scanning of monastic architecture around the Early Christian church in Sohag (Middle Egypt) failed to give the expected results. The area has been in continuous use for 1500 years, which has left it dotted with various metal objects, cinder heaps and ash dumps disturbing magnetic measurements. The resistivity method was useful in these conditions, and there are plans to continue the survey with application of this method.

At Wadi Natrun remains of monastic complexes around the Early Christian monastery of St. John the Little were recorded. The picture of the architecture originating from a fieldwalking of the area was clarified in many instances.

The research at Bawit (Coptic period) has already covered 30 ha, which constitutes 3/4 of the town's surface. Two previously unknown churches were identified, fragments of monastic complexes and an industrial centre (consisting of several dozen furnaces). The extent of the town can be established quite precisely by the survey. One of the tasks of the survey was a real map of the archaeological site, which resulted from the proper localization of features identified during excavations in the early 20th century.

The work was conducted in cooperation with the Polish Centre of Mediterranean Archaeology of Warsaw University, Cairo branch; Programa de Estudios de Egiptología (Consejo Nacional de Investigaciones Científicas y Técnicas) in Buenos Aires, American Research Center in Cairo, British Museum, Centre d'Etudes Alexandrines, Centre Franco-Egyptien d'Etude des Temples de Karnak, Deutsches Archäologisches Institut, Trinity International University, Institut Français d'Archéologie Orientale du Caire, Musée du Louvre, Österreichisches Archäologisches Institut, University of California Los Angeles, University of Liverpool and Yale University.

REFERENCES

- Herbich 2001* T. Herbich: Archaeological geophysics in Egypt: recent results. In: Archaeological Prospection, 4th International conference on archaeological prospection. M. Doneus, A. Eder-Hinterleitner, W. Neubauer (eds), Vienna 2001, 112-114.
- Herbich 2003* T. Herbich: Archaeological geophysics in Egypt: the Polish contribution, *Archaeologia Polona* 41, 2003, 13-55.
- Herbich 2005* T. Herbich: Geophysical surveying in Egypt: recent results. In: 6th conference on Archaeological Prospection, Rome 2005, 1-5.

Tomasz Herbich

Institute of Archaeology and Ethnology, Polish Academy of Sciences
Al. Solidarności 105, 00-140 Warszawa, Poland
tomasz.herbich@gmail.com
herbich@iaepan.edu.pl

LATE BRONZE AGE SETTLEMENT IN THE MIDDLE NITRA REGION: APPLICABILITY OF GIS ANALYSES

Milan Horňák - Susanne Stegmann-Rajtár

Key words: landscape archaeology, GIS, Late Bronze Age, settlements

The cultural mosaic of the middle Nitra region underwent intensive changes in the Late Bronze Age. The archaeological record of the Čaka Culture certainly vanished, and the related Lusatian Culture started to model the cultural landscape. It is necessary to stress that the latter culture is not a new factor in this region, but rather represents continuity in the settlement, which is based on the development of the Younger Bronze Age. The people of the Lusatian Culture kept the main forms and characteristics of the settlement patterns (for example settlement types, building of hill forts, long duration of cemeteries) during the whole Late Bronze Age as well as in the beginning of the Hallstatt period. This means long duration of the cultural landscape, which is more stable and compact than the visible changes of the material culture. This stability is highly determined by environmental factors (such as morphology of terrain, hydrology, suitability of the soil for agriculture), and also by the intensity of economic, social, cultural and historic processes, which are connected with the organization of landscape and settlement.

The intensity of this cultural and historic processes can be observed in the changes in quantity, quality and uses of archaeological artefacts, in the acceptance of material and ideological impulses from others cultural groups and, of course, in changes in the settlement patterns. These kinds of modifications in the archaeological record and in the landscape can be analyzed on different levels of archaeological entities: artefacts, ecofacts and settlement complexes. This means that the understanding or the archaeological reconstruction of a cultural landscape depends on the analyses and syntheses of the material culture, settlement patterns, paleoenvironmental conditions and on other cultural concepts and habits (e.g. symbols, religious or cosmologic perceptions). Processing such data enables us to define, understand and interpret settlement patterns of regional and macroregional importance as well as to identify the reciprocal relationships among sites and their relationship towards the environment and society.

The map of distribution that shows these relationships is not merely an archaeological map of points (artefacts, sites), but rather a rich and structured map of settlement shapes or areas. Every relationship or its weight and intensity defines the correlation between the environmental conditions (terrain, river network, natural sources) and archaeological complexes (hill forts, villages, cemeteries and other sites). All this is additionally conditioned by cultural and social factors (level of civilization, ideology, organization of landscape, local economy).

With regard to the distinct long duration or small changes in the cultural landscape or settlement patterns of the researched region, we suppose that all of the above is a result of the defined determinants (environmental and cultural), which we try to confirm with GIS and others landscape analyses.

Milan Horňák
University in Ljubljana
Faculty of Arts Department of archaeology
Zavetiška 5
1000 Ljubljana, Slovenija
hornak.milan@gmail.com

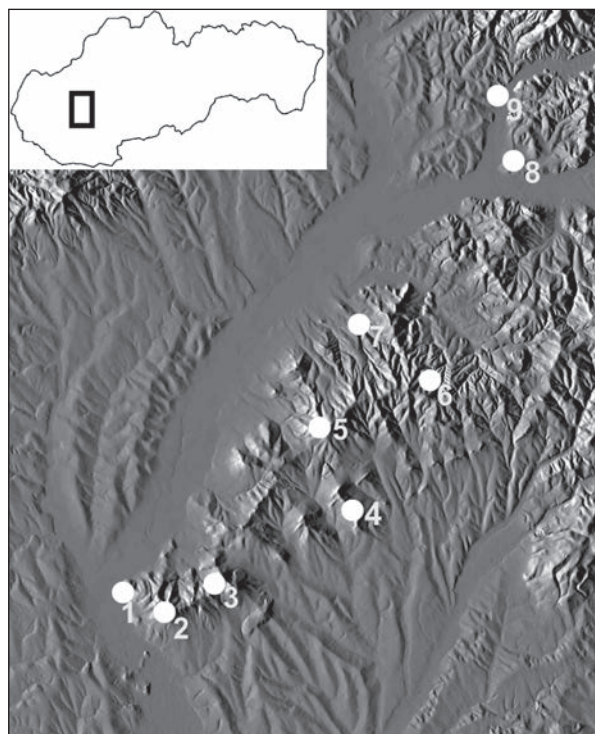

Fig. 1. Distribution of the main HB/HC hill forts, shown on an enlarged hillshaded map of the Middle Nitra region. 1 - Nitra-Drážovce, distr. Nitra; 2 - Nitra-Zobor, distr. Nitra; 3 - Štitáre-Žibrica, distr. Nitra; 4 - Kostoľany pod Tribečom-Veľký Lysec, distr. Nitra; 5 - Kovarce-Veľký Tribeč, distr. Topoľčany; 6 - Klátová Nová Ves-Šiance, distr. Topoľčany; 7 - Krnča-Tábor, distr. Topoľčany; 8 - Malé Kršteňany, distr. Topoľčany; 9 - Hradište, distr. Topoľčany.

Susanne Stegman-Rajtár
Archaeological institute of SAS
Akademická 2
949 21 Nitra, Slovakia
zuzana.rajtarova@savba.sk

FEASIBILITY OF A TOWED EM AND MAGNETIC DEVICE FOR ARCHAEOLOGICAL PROSPECTING

Guillaume Hulin - Michel Dabas - Alain Tabbagh - Jeanne Tabbagh - Julien Thiesson

Key words: magnetizing prospecting, EM prospecting, forward modelling, towed arrays, sensors

Nowadays, the magnetic method is mainly used in archaeological survey due to its easy implementation and also its good efficiency to detect buried structures. Indeed, whether the electrical method is the best solution for detection of buried masonry remains, methods based on magnetic properties give the best results in detecting excavated structures (pits, post holes, ditches, field boundaries,...) which are the most common structures discovered during evaluation over large surfaces in rescue archaeology (surfaces generally more than 10 ha such as motorways, industrial parks,...). If such buried features are not detected over large areas that means we neglect a very important part of archaeological information specifically for pre-roman periods. For several years, GEOCARTA has developed a technology of continuous

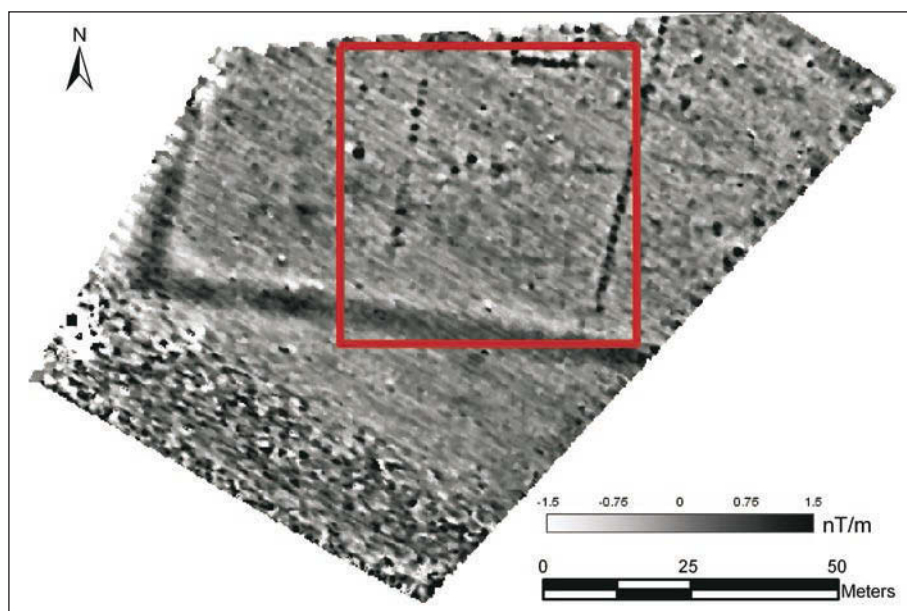

Fig. 1. Automatic Magnetic Profiling (AMP) survey on the A19 Iron Age site (0.9 ha in less than 2 h). Only the large ditch enclosure was detected by resistivity survey. The square corresponds to the test area (50x50 m).

electrical resistivity measurements (ARP) and since 2006 has developed a similar technology for magnetometry (AMP) which has been validated over several fieldworks. The combination of several methods measuring different physical properties is recognized to be a primordial aspect in order to optimize the geophysical information and interpretation. However, due to practical issues of electromagnetic interferences between ARP and AMP, combination of both techniques is not easily possible and a new solution has to be developed. Thus, coupling of magnetic and electromagnetic sensors on a same platform towed by an all terrain vehicle (quad bike) seems to be an excellent trade-off to satisfy multiple expectations of archaeologists.

The paper presents a complete approach of different magnetic configurations allowing the optimal detection of the most common archaeological structures. In a first step, measurements of magnetic susceptibility on soil samples from typical archaeological structures gave us an idea of magnetic contrasts which occur in such structures. In a second step, 3D forward modelling of magnetic responses created by realistic features permit us to estimate values which could be measured by different sensors off the shelf. A close attention was focused on the optimization of some instrumentation and configuration parameters like scalar versus vector measurements, total field versus differential measurements, elevation of sensors, horizontal and vertical spacing... Modelling of effects occurring during the survey (angular oscillations, variations of sensor's height...) was also performed. In a third part different sensors and configuration arrays were evaluated on a test area in order to confirm and show up the possible weaknesses of the forward modelling. The last step concerned the integration of EM and magnetic sensors on a same platform and problems due to the highly magnetic effect of the towing vehicle.

Thus, this study highlights different important points allowing the best design of sensor array in order to detect the largest possible range of structures.

Guillaume Hulin
 Geocarta, 16 rue du Sentier
 75002 Paris, France
 g.hulin@geocarta.fr

Michel Dab5as
 TERRA NOVA
 16 rue du Sentier
 75011 Paris, France
 dabas@geocarta.fr

Alain Tabbagh
 Jeanne Tabbagh
 Julien Thiesson

Département de Géophysique Appliquée, UMR 7619 Sisyphe
 Université Pierre et Marie Curie
 4 place Jussieu
 75252 Paris Cedex 05, France
 alat@ccr.jussieu.fr
 tabbagh@ccr.jussieu.fr
 Julien.Thiesson@ccr.jussieu.fr

APPLICATION OF GEORADAR METHOD FOR ENGINEERING AND GEOLOGICAL SURVEYING OF HISTORICAL PLACES

Sergey K. Izyumov - S. Mironov - Vojtech Gajdoš

Key words: geoelectrical methods, radar tomography, archaeological prospecting

Introduction

Conventional methods of engineering-and-geological surveying such as drifting of excavations (prospecting shafts, ditches, clearings etc.) or well-boring are sometimes not enough to completely solve the task of obtaining full and reliable engineering-and-geological information when surveying foundations of church buildings and structures which are over 100 years old.

This accounts for by the fact that wells and excavations are made at definite distances from each other. In between positions can be imagined as a result of interpolation and are as a rule of subjective nature. Densening of well and excavations pattern leads to increase in the cost of surveying, which sometimes can not be executed at all because of the



Fig. 1. Antenna photos of TR-GEO radar modified for archaeological measurements.



Fig. 2. Photos from radar measurements on the territory of New-Jerusalem Monastery.

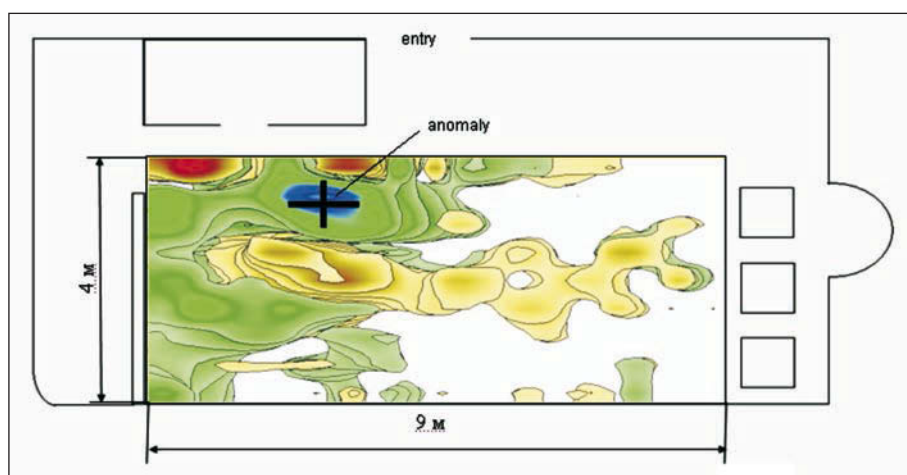

Fig. 3. Anomaly of radar reflex in the depth of 6-7 m.

dense conditions for those works. Moreover, this type of surveying has to be conducted in a very careful and detailed manner. The surveying must be guided by “do not cause damage” principle. Therefore, for obtaining more specific engineering-and-geological information it is necessary to apply additional non-destructive surveying methods. Geophysics provides for numerous methods of solving of geological tasks, including electrical sounding, seismic surveying etc. Georadar method is considered to be one of the most advanced and fast-developing methods.

At present our company has gained a lot of experience in practical application of TR-GEO georadars for monitoring of the state of a ground massif. We have at our disposal a number of TR-GEO georadars for various applications which differ in ranges of working frequencies and in depth of sounding. TR-GEO-D georadars with antennas which are 55x100 cm in size and with the maximum depth of sounding in ground of about 40 m are applied when executing sounding from ground surface and imaging geological sections. TR-GEO-01 georadars with antennas which are 30x40 cm or 40x40 cm in size are designed for detecting flaws in structures and for sounding of grounds which are lying in close vicinity from the surface at the depth of up to 6-7 m.

TR-GEO georadars are equipped with screened slot antennas which have been specially developed for application in dense urban conditions. Those antennas have low level of parasitic reflection in reversed direction. It is of importance when operating the instrument in conditions of multistoried dense buildings, since reflections from reinforced concrete walls and metallic objects (motor transport) produce noise. Deformable layer of resistive material can be added to the upper and lower sides of antenna, ensuring thus the suppression of that noise. This material partially filled in the uneven surface and prevented wave outlet in the gap between the antenna and the ground. This technique and other coverings of antennas (on the side and at the rear) were studied experimentally and numerically by using the finite difference method.

TR-GEO georadars are designed for detecting of metallic, dielectric items and other objects or layers, as well as of cavities and decompaction zones which have rather sharp boundaries and differ in dielectric permeability or conductivity as compared to the surrounding ground.

The video pulse method of sounding serves as a basis for performance of TR-GEO georadars. A transmitting antenna produces a short video pulse, which, upon being reflected from the object, is received by a receiving antenna. The radars can be applied in media with low and moderate attenuation of radio waves, i.e. in hard rocks, wet sandy grounds and sandy loams, low wet clays and clay loams. The radar usually allows for distinguishing of more or less conductive objects and of more wet areas as compared to the surrounding ground, which is based on the sign of the first half-period of reflected signal.

In accordance with the frequency increase, especially starting with frequencies of 100-200 MHz, the absorption of radio waves by the wet sandy-and-loamy ground is also in increase. The absorption is especially high in wet loamy grounds. Therefore the mean spectrum frequency for signal and hence the type of radar and the size of used antennas are selected to ensure the necessary amplitude of reflected signal at required depth of sounding in given grounds. In some cases the application of instrument with high resolution makes it possible to proceed with detecting small objects and special characteristics of ground composition. It requires the increase in working frequencies within pulse spectrum and selecting of radar with higher frequencies.

For interpretation of data it is necessary to be aware of amplitude and form of the signals reflected from various man-made and natural objects depending on depth, type and moisture-content of ground. To ensure it, a lot of measurements and numerical modelling of complex dielectric permittivity of wet sandy-and-loamy ground in broad frequency range was arranged. Signals upon reflection from possible objects of sounding were modeled. The data base which has been obtained in that way is planned to be used for future development of automatic result interpretation software.

Archaeological sites

Geophysical surveying using TR-GEO georadars was arranged in Holy Trinity and St. Sergius Monastery in Sergiev Posad, in New-Jerusalem Monastery, in Holy Assumption Monastery and in many other historical places in Russia.

On the territory of Holy Trinity and St. Sergius Monastery following objects were under investigation: geological massif for foundations of architectural group consisting of Cathedral and Hospital Chambers along with the adjacent Church, geological massif in the inner yard of Academic Building, the floors in big room of the Refectory. As a result of surveying it was possible to detect abnormalities in composition of ground basis for foundations in buildings of architectural group as well as zones with increased water saturation. Underground structures

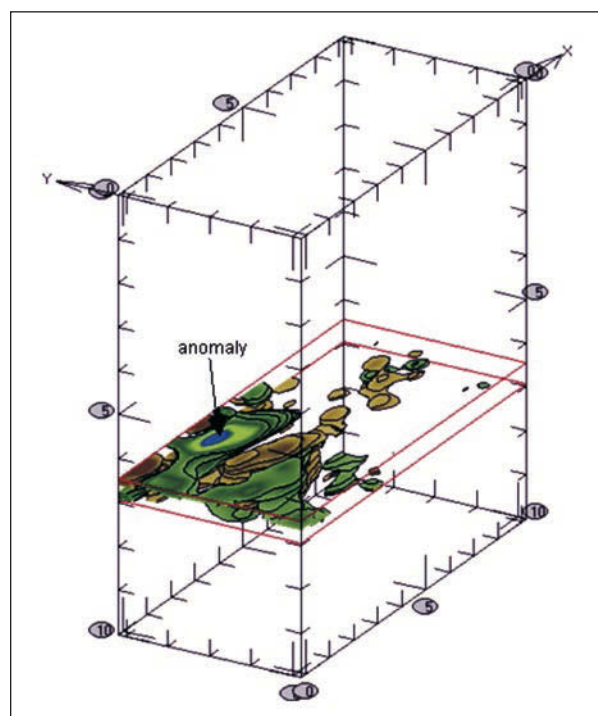

Fig. 4. The same anomaly of radar reflex in the 3D imaging.

– fragments of drainage system as well as buried cellars were found in the yard of Academic Building. Numerous passage air ducts were detected under the floor of Refectory (result examples of these fragments are on the Fig. 3 and 4).

On the territory of New-Jerusalem Monastery geological massif of foundations for walls and floors in Resurrection Cathedral was surveyed. It was possible to localize peculiar characteristics in composition of ground basis for wall foundations as well as a great number of abnormalities in the foundation of floor in Cathedral including very old burial places.

The surveying conducted on the territory of Holy Assumption Monastery allowed to fix the foundations of destroyed cathedral and numerous buildings and structures as well as to determine the depth of cultural layer.

Conclusion

The data obtained testify that the proposed method is promising for investigating man-made grounds of cultural layer on the territory of historical places. High density of the measuring net of radar surveying can allow location of relatively little piece of archaeological structure in area of architecture relict.

Sergey K. Izyumov
S. Mironov
Geological Prospecting Co., Ltd., Moscow, Russia
trgeo@trgeo.ru

Vojtech Gajdoš
Department of Applied and Environmental Geophysics
Faculty of Sciences, Comenius University
Mlynská dolina
842 15 Bratislava, Slovakia
gajdos@fns.uniba.sk

GEOPHYSICAL SURVEY AT TOKUSHIMA CASTLE IN JAPAN

Akihiro Kaneda - Yasushi Nishimura - Yoshiaki Miyake - Jyunichi Shimoda - Hisao Nezu

Key words: GPR, Resistivity, castle

Tokushima Castle was constructed in the early 17th century as a base for operations by a local clan empowered to rule the surrounding territories on the southern Island of Shikoku in Japan. According to visual observations, some parts of the medieval castle fortifications appear to have different methods used

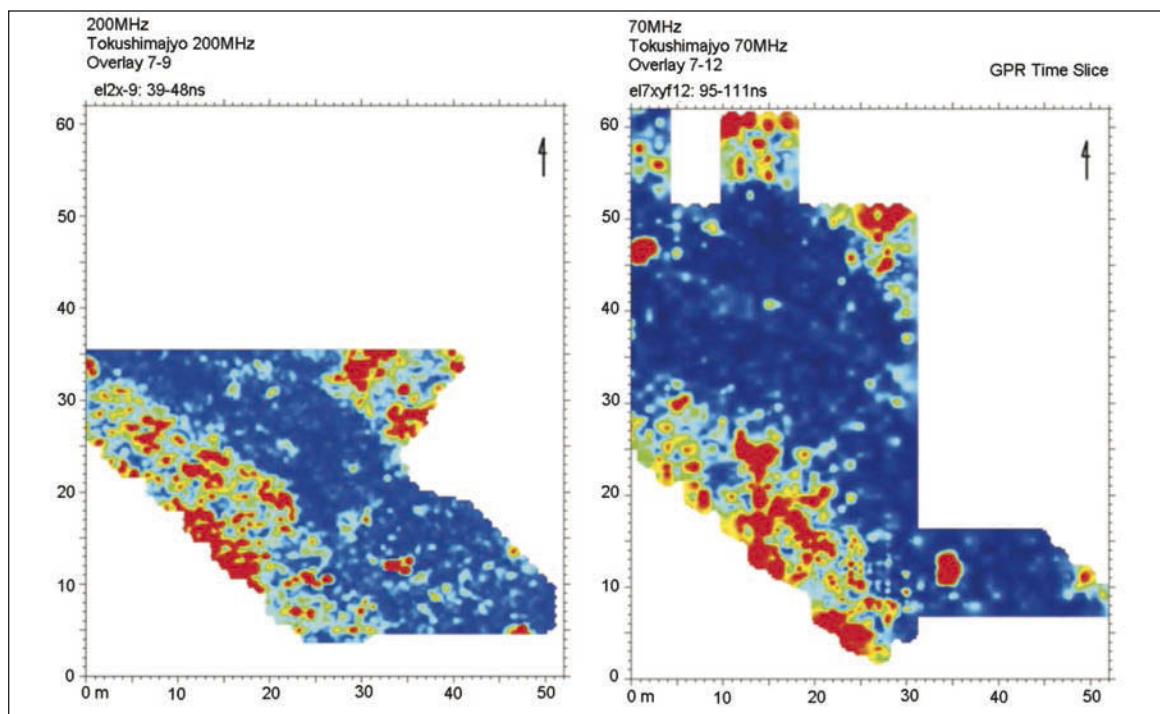

Fig. 1. GPR Time Slice, 200 & 70 MHz antennae.

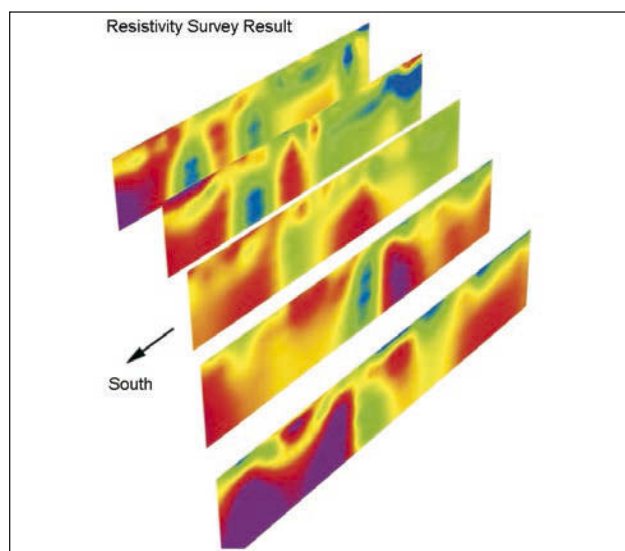

Fig. 2. Resistivity survey result.

Akihiro Kaneda
Yasushi Nishimura
National Research Institute for Cultural Properties
Nara, Japan
akaneda@nabunken.go.jp
yasushi@nabunken.go.jp

Yoshiaki Miyake
Jyunichi Shimoda
Hisao Nezu
Board of Education, Tokushima-shi, Tokushima Pref., Japan
shakai_kyoiku@city.tokushima.lg.jp
shakai_kyoiku@city.tokushima.lg.jp
johaku@tk2.nmt.ne.jp

in construction, with some areas of the wall adorned with protective and decorative soils. It is believed that the wall was remodelled several times by the addition of new soils and stone to the outside portions, with older parts of the wall kept buried as an interior reinforcement. For detecting the subsurface wall structures, GPR and resistivity surveys were applied. A GSSI SIR 3000 employing both 200MHz and a 70 MHz antenna for deeper penetration was collected at profile intervals of 50 cm and 1m respectively. The GPR survey results clearly detected an unexpected rectangular stone fortification, which was also corroborated by resistivity profiling.

INTEGRATED GEOPHYSICAL SURVEY AROUND MT. KAIMONDAKE, JAPAN - TO SEARCH AN ORIGINAL LOCATION OF HIRAKIKI SHRINE

K. Kogawa - H. Kamei - M. Honda - S. Nagase - D. Kamimura - K. Shinba

Key words: volcanic disaster area, resistivity survey, GPR survey

Mt. Kaimondake is an active volcano and is located in the southwestern part of Kagoshima Prefecture, Japan. It is called "Satsuma-Fuji" because it is a typical stratovolcano and has a beautiful conical shape like Mt. Fuji. Mt. Kaimondake has been recognized as a home of a god since ancient times; Hiramiki shrine was originally built to worship the mountain as a home of a god. The shrine has a history of more than 1200 years. Now the shrine is located in the northeastern part of Mt. Kaimondake (Fig. 1). According to the tephrochronology, the mountain has erupted four times in the last two thousands years. The eruption in 874 was recorded in historical texts "Nihon Sandai Jitsuroku". Hiramiki shrine suffered from a volcanic disaster in 874 and was moved far from Mt. Kaimondake. It is presumed that the shrine originally existed where the Kaimon junior-high school stands now. Two geophysical techniques, the resistivity and GPR surveys, were applied to detect any remains of the shrine in the schoolyard.

In the resistivity survey, MEDUSA (Multi Electrode Device for Underground Survey in Archaeology) was used. This data acquisition system is composed of a resistivity meter SuperString R8/IP (Advanced Geosciences, Inc., USA), which is capable of simultaneous measuring in 8 channels, 32 electrode selectors and a Personal Computer (PC). The electrode selector has two current terminals and two potential ones, and can connect each terminal to an arbitrary electrode. Four terminals (two of them are current terminals and others are potential terminals) of the SuperString R8/IP are parallel connected to terminals of each electrode selector. The PC controls the SuperString R8/IP via RS-232C interface and the electrode selector via USB interface. The electrode selector is composed of a USB interface and units as a set of one controlling board and two relay boards. The unit is connected to maximum 16 electrodes. As one electrode selector can control maximum of 16 units, totally there can be controlled up to

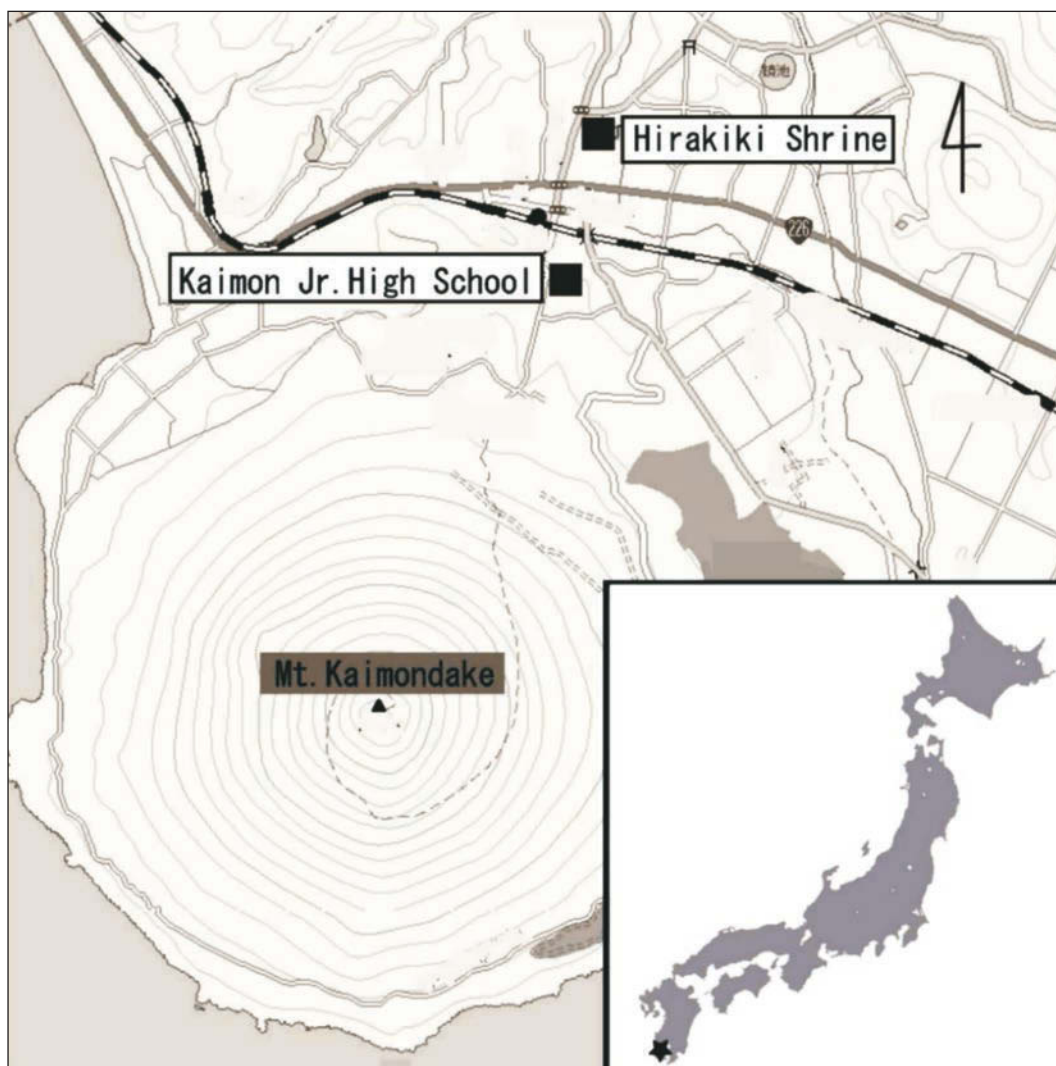

Fig. 1. Map of around Mt.Kaimondake. These maps are modified on the Internet, Yahoo! Japan (<http://map.yahoo.co.jp>) and CraftMap (<http://www.craftmap.box-i.net>).

256 electrodes. USB interface has 32 ID addresses, and can therefore logically connect up to 32 electrode selectors at the same time. In other words, this MEDUSA system can control a maximum of 8192 electrodes.

The MEDUSA system is designed for the surface potential method and can also be used as a conventional survey system with several electrode configurations, for instance, Wenner array, Schlumberger configuration, dipole-dipole etc (Arai, *et al.*, 2005).

In this survey, 128 electrodes were set every 0.5 m in one line. Wenner array with its electrode spacing of 0.5 m to 14.0 m was adopted to make an apparent resistivity profile. A distribution of resistivity is shown in Fig. 2 converted from the apparent resistivity profile by the inversion software Res2DINV. On the whole, the resistivity values are very high, because most of the geologic formations are made of lava and consolidated volcanic ash. The result of boring exploration at the point of 40 m from the southern end on the line shows that an inclining high resistivity part is volcanic ash layer. It is also assumed that another high resistivity part around 20 m on the line is a volcanic ash layer. It seems that these inclining layers are deposited along the mountain's body. On the contrary, a high resistivity part around 10 m shows a different shape from the other two; it is nearly vertical.

GPR survey was implemented with the pulse EKKO PRO system (Sensors and Software Inc., Canada). Fig. 3 shows a GPR profile by use of 500 MHz antenna along the line overlapping the line of resistivity survey. The length of its line is 75 m and its starting point is 10 m to the south of the origin of resistivity. The two volcanic ash deposits found by resistivity survey could be seen at the same points in the GPR profile. In addition, it can be seen that there is a linear reflection pattern around 10 m point. The inclination of this reflection pattern is steep. We can find a hyperbolic reflection pattern at the end of linear reflection pattern. This anomaly seems to be artificial and may be interpreted as a stone wall.

This research was supported by Grant-in-aid for Scientific Research, Grant number 16089206, the Ministry of Education, Science, Sports and Culture, Japan.

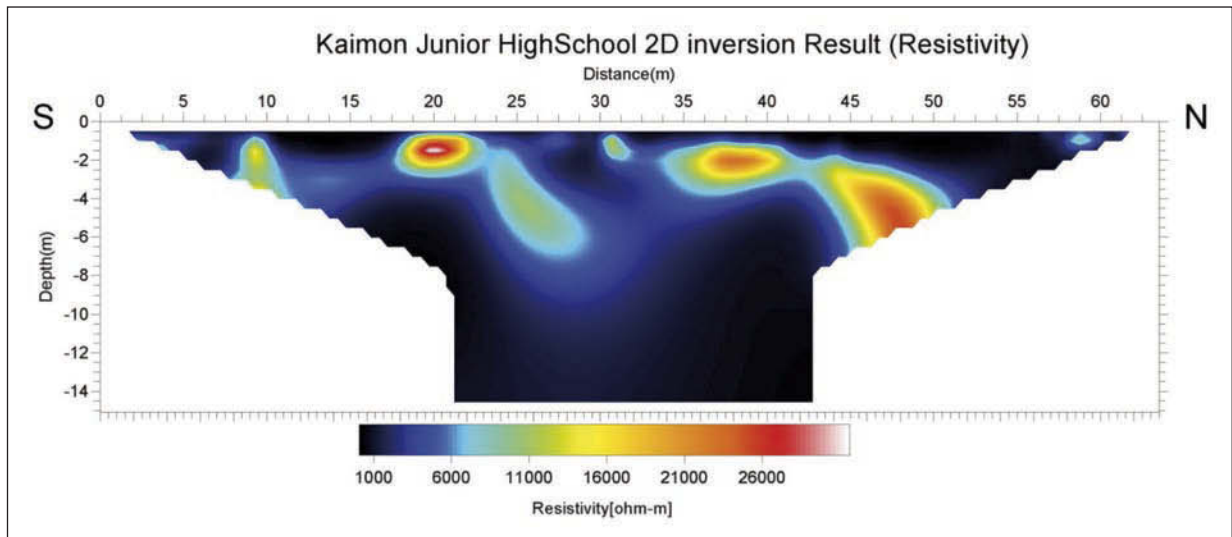

Fig. 2. The result of resistivity survey.

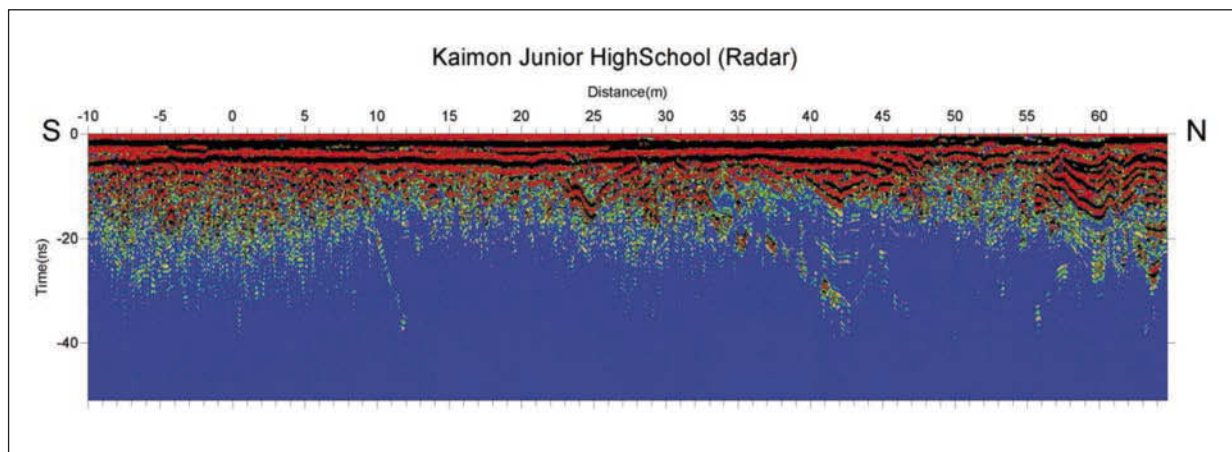

Fig. 3. The result of GPR survey.

REFERENCES

Arai/Honda/Kamei/Sekiguchi 2005

H. Arai/M. Honda/H. Kamei/T. Sekiguchi: Three Dimensional Resistivity Survey System Using Surface Potential, The 6th International Conference on Archaeological Prospection., Rome 2005, 191-194.

Luke 2002

M. H. Luke: Tutorial: 2-D and 3-D electrical imaging surveys, University Sains Malasia 2002.

K. Kogawa
H. Kamei
M. Honda
S. Nagase
D. Kamimura
K. Shinba

Tokyo Institute of Technology
Graduate School of Decision Science and Technology
Department of Human System Science
W8-72 2-12-1 O-okayama, Meguro, Tokyo 152-8552, Japan
kamei@archaeo.cs.titech.ac.jp
katsura@archaeo.cs.titech.ac.jp

EARLY MEDIEVAL SETTLEMENTS IN THE KISLOVODSK BASIN (SOUTH OF RUSSIA): GIS, AERIAL PHOTOGRAPHY AND GEOPHYSICS

Dmitry S. Korobov

Key words: GIS, aerial photography, geophysics, South of Russia, settlements, Early Middle Ages

One of the most important approaches in modern archaeology is the investigation of the settled systems of the past. Such studies are the main part of 'landscape archaeology', which researches interactions of humans and the environment. GIS, which has been employed by archaeologists more and more actively since the mid 1980s, is a stimulus to this research.

In 1996, a project led by Dr. G.E. Afanasiev was begun at the Institute of Archaeology of the Russian Academy of Sciences, its main goal being investigation of the settlement system of the Alans. These multiple tribes occupied the South of Russia in the Middle Ages, and played an important role in East-European history. The Kislovodsk basin was chosen as a region of investigation because it is comparatively small and geographically closed depression in the Central Caucasus with a huge number of known sites. During several years our team was making a field survey preparing a map of the archaeological sites of the region, which was the first GIS project in Russia (Korobov 2001). Not long ago the results of this survey were published as a monograph (Afanasiev *et al.* 2004). This work formed the background for the analysis of the sites of different periods and types found near the modern spa-town of Kislovodsk.

The poster concerns an investigation of the settlement system of the Alans in the Kislovodsk basin in the Early Middle Ages. This research is carried out by modern computer technologies and unique programs such as a special module for paleoclimate reconstruction. Aerial photography is also used and sometimes gives us an impression of the sites as a whole (Fig. 1). Field studies are carried out on settlements of several types and they are based on the instrumental topography, which is the basis for computer 3D modelling (Fig. 2), and on the small test excavations and geophysical prospection.

At the moment the first results were obtained. First, all the settlements were divided into several classes according to their topographic position (remnants, edges of promontories, slopes, hills and so on). Site catchment's analysis in GIS shows that these settlements are connected very close with the local catacomb cemeteries and most of them could be dated to the period between 450 and 750 AD. Viewshed analysis gave very interesting results that prove our topographic classification: the type of the small strongholds made on the top of the hills had the largest area of visibility around and could be seen as a special system of the "signal posts". The experiment on transfer of a smoke signal helps in calculation of the 10 km zones around these posts for optimal visibility. A modelling of the viewshed areas with a 10 km limit around the strongholds demonstrates the system of control over the whole territory in the Kislovodsk basin. In this system each "signal post" observed a part of area and was able to communicate with other similar sites.

The special module of investigation of a paleoclimate made by specialists in GIS and geography is a powerful tool for climate reconstruction. Using this module 3500 measurements of temperature, humidity and radiation

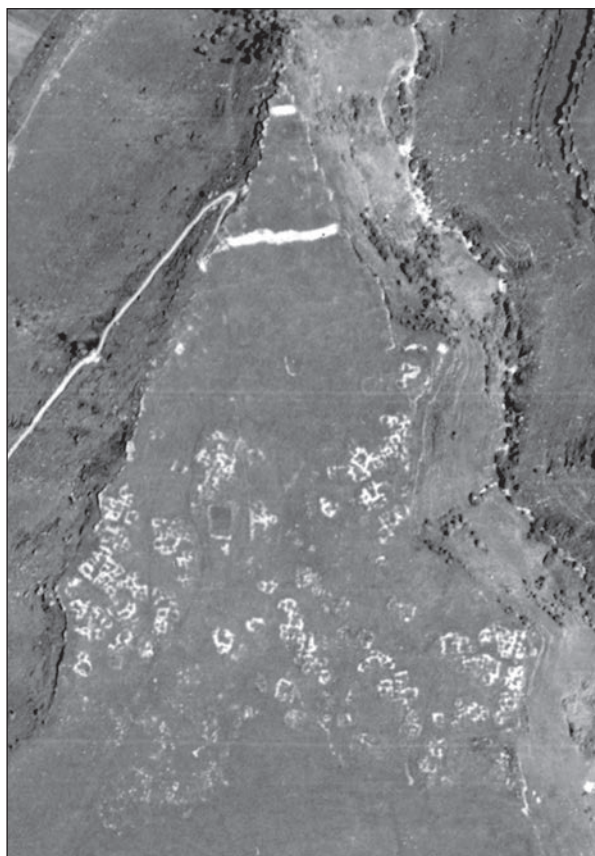

Fig. 1. 3D-model of the landscape with the Early Medieval strongholds of Moseykin Mys 1-2 near Kislovodsk.

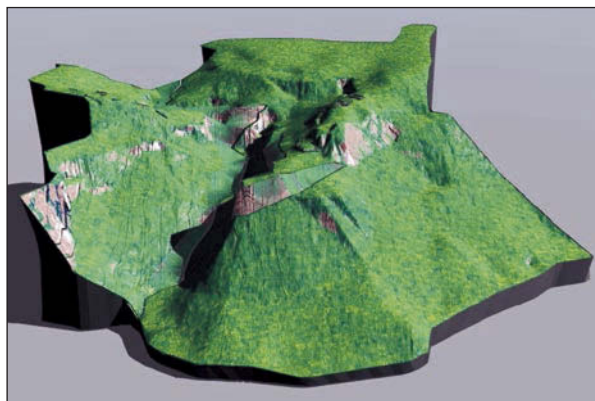

Fig. 2. Aerial photo of the Medieval settlement of Ullu-Dorbunlu near Kislovodsk.

of the modern and “disturbed” climate of Early Medieval period were done. All the settlements were combined to groups with similar climatic characteristics with a help of cluster analysis. As a result four groups of sites of modern and ‘disturbed’ climatic situation were divided and their climatic values were analyzed with a procedure of Box-and-Whisker Plot, and the results of the cluster analysis were mapped with GIS. Mapping the climatic characteristics of four clusters of the settlements allowed define two main landscape zones of habitation in the Kislovodsk basin depending on the different height. The main result of the simulation is a hypothesis that in the Early Middle Ages the populated zones of the basin were fit for agriculture besides cattle farming. The traces of this Early Medieval agriculture could be observed as terraced fields that partly have been already mapped with help of aerial photography (Korobov 2003).

An effective and detailed analysis of the settlement could be done by means of geophysical prospection that was done on several sites. Part of the stronghold of Moseykin Mys 2 was investigated by S. V. Merkulov (GUP “Nasledie”, Stavropol’ region) in 2003. The GPR model of “LOZA-M” with antennas of 50 MHz frequency was used. Small structures observed on the depth of around 1 m were found later in the excavation trench. In 2006, J. W. E. Fassbinder (Bavarian State Department of Monuments and Sites) prospected around 22 000 m sq. on the settlement of Borgoustanskoe 4 using the Cesium Smartmag SM 4 magnetometer in a total field configuration. Traces of a ditch and a fire place (Fig. 3) were possibly found there and should be proved by consecutive excavations.

The investigation of the Early Medieval settlements in the Kislovodsk basin makes the first steps towards reconstruction of the settlement system of the Alans in the South of Russia. We expect to obtain new interesting results in the nearest future.

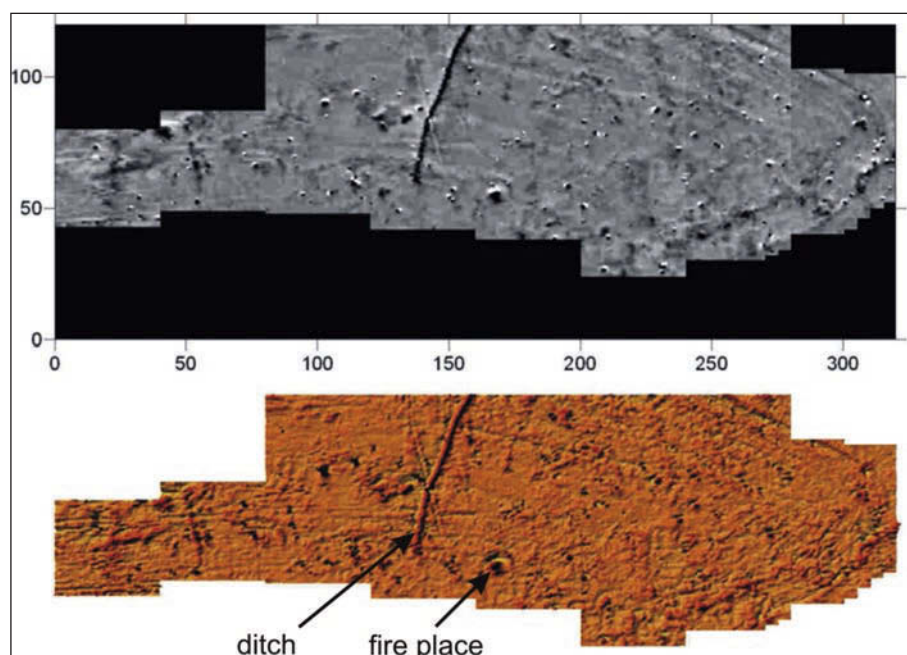

Fig. 3. Results of magnetic prospection on the settlement of Borgoustanskoe 4 near Kislovodsk.

REFERENCIES

Afanasiev/Savenko/Korobov 2004

G. E. Afanasiev/S. N. Savenko/D. S. Korobov: *Drevnosti Kislovodskoj kotloviny* (The Antiquities of the Kislovodsk basin). Moscow 2004.

Korobov 2001

D. Korobov: Archaeological prospection in the Kislovodsk basin (South of Russia): GIS and aerial photography. In: *Archaeological Prospection*. M. Doneus, A. Eder-Hinterleitner, W. Neubauer (eds.). 4th International Conference on Archaeological Prospection. Vienna 2001, 133-135.

Korobov 2003

D. Korobov: Investigation of agricultural terraces in the South of Russia. In: *Archaeological Prospection*. Z. Kobyliński (ed.). *Archaeologia Polona* 41. Warsaw 2003, 212-216.

Dmitry S. Korobov

Institute of Archaeology of Russian Academy of Sciences
 Dm. Uljanova, 19
 117036, Moscow, Russia
 dkorobov@mail.ru

POSSIBILITIES AND LIMITATIONS OF SURVEYS BY CAESIUM MAGNETOMETERS IN FORESTED TERRAINS OF ARCHAEOLOGICAL SITES

Roman Křivánek

Key words: magnetometric survey, settlement, production feature, barrow cemetery, field condition

The continuous style of measurement by different types of atomic magnetometers has been an intensively applied method of archaeoprospection in the last years. These very powerful geophysical instruments were effectively used in different scales of surveys of open and mainly flat archaeological terrains. Agricultural areas as arable fields, pastures and meadows or abandoned desert areas in arid regions seemed to be optimal landscapes for this type of magnetometric survey. Generally it is only in these conditions that it is possible to use large scale magnetometric measurements also with parallel measurement of more sensors. The application of for example caesium magnetometers in a more complicated sloped or forested terrain seemed to be problematic and less efficient or non-perspective, due to more aspects of specific measurement, sensitivity or interpretation. This contribution documents that magnetometric surveys by single Cs-magnetometer could bring interesting results also from various forested archaeological sites.

Caesium magnetometer Smartmag has been used for magnetometric surveys in Prague since beginning of 1998. The most of gradient single profile variant measurements were concentrated also to larger surveys of (present or former) ploughed out archaeological terrains. But more situations were also studied and surveyed in less suitable conditions as in locally remodelled, variably sloped or forested terrains or in more complicated geological and pedological conditions. Magnetometric measurements in forested areas of important archaeological sites were realised also in archaeological projects in the last years (project "Geophysical survey in the archaeologically uninvestigated parts of Czech oppida", Grant agency of the Academy of Sciences of the Czech Republic: Křivánek *et al.* 2003-2007, A8002301 or research project "The Neglected Archaeology", Dept. of Archaeology of the University of West Bohemia in Pilsen; 2005-2009, MSM 4977751314). Most of the magnetometric measurements were applied in grid-net 1x0.25 m, details and smaller situations also in grid-net 0.5x0.2 m. Magnetometric results from more complicated situations were combined also with other methods.

Hillforts

Geophysical surveys of hillforts in forested areas without lower vegetation and hardly passable terrains could be applied by different methods of survey. Magnetometric measurement could be concentrated to verification of hillfort fortification or study of inner structure of settlement and other activities. In combination with geoelectric resistivity measurements we can concentrate on entrances, gates, ramparts or communications. Suitable areas for surveys and for quality of results are only more limited by (modern or later) landscape and terrain changes and intensity of vegetation. Magnetometric surveys of more forested areas of La Tène oppidum near Závist, distr. Prague-west were done during an archaeogeophysical project in last years (Křivánek 2004). A new gate, an old communication or deser-

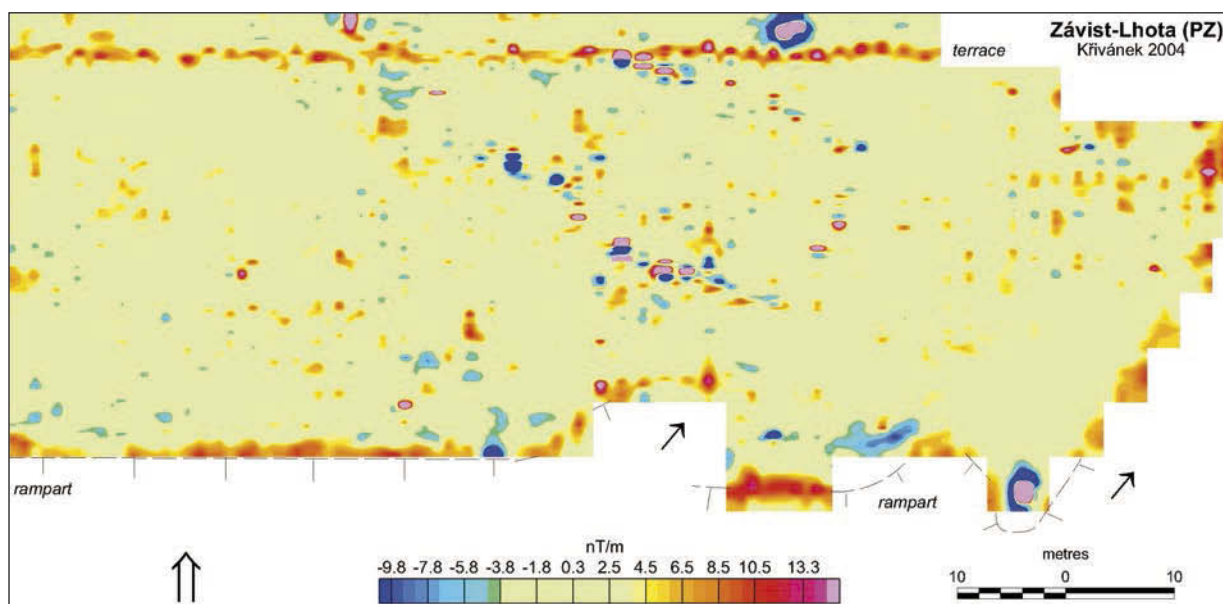

Fig. 1. The identification of narrow interruptions of perimeter rampart and internal terrace without intensive settlement activity in outer forested part of oppidum Závist (surveyed area 0.5 ha).

ted arable fields older than 18th century were identified in forested parts of the oppidum (*Křivánek 2005*). The other magnetometric surveys over an extremely large site confirmed presence of more interruptions (narrow entrances from lower sloped terrains) in perimeter rampart and terrace inside a fortified area without identification of concentrated settlement (different use of area) or sunken features (Fig. 1).

Barrow cemeteries

The efficiency of applications of magnetometric measurements in areas of forested barrows depends on the type and material of barrow and/or on funeral activity. Magnetometric measurements are often combined with geoelectric resistivity measurements, but also with electromagnetic or GPR measurement. The result from Cs-magnetometers is possible to use not only for identification of burial mounds but also for separation of potential outer flat graves or for observation of the state of subsurface preservation of funeral features. Magnetometric measurement in forested area of a Bronze Age barrow cemetery near Údraž, district Písek, confirmed expected coincidence of mapped elevations with magnetic anomalies of barrows (Fig. 2). Results showed also more subrectangular shape of barrows, possible interruptions inside the features and place of possible sunken feature outside the barrows.

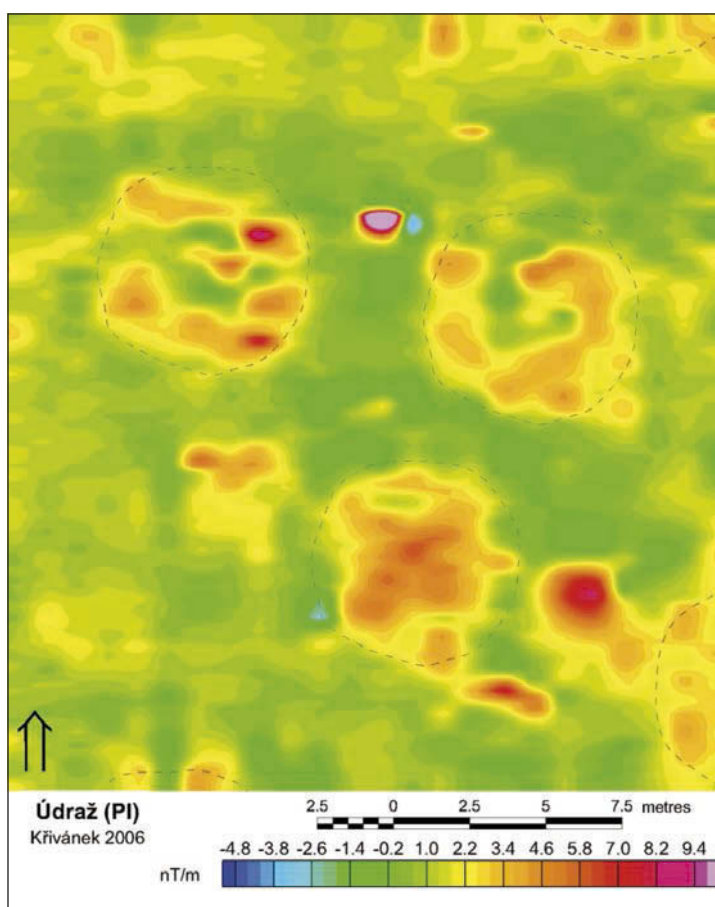

Fig. 2. The separation of 3 subrectangular barrows of larger forested Bronze Age barrow cemetery near Údraž (surveyed area 23x25 m).

Deserted villages

In the observed area the magnetometric method can be combined with other geophysical methods such as geoelectric resistivity measurement. The combination of these methods in the survey of assumed farmsteads of deserted medieval village near Kersko, distr. Nymburk helped to separate different subsurface remains and materials of medieval homesteads (remains of stony masonry, clay concentrations, presence of loam, brickwork remains,...) damaged by new forestation of flood plain and lowland area (*Křivánek/Klír 2007*).

Production areas

Magnetometric method (in combination with detailed field surface survey) is generally the most suitable geophysical method for field prospections or detailed studies of all of production features (for example iron, glass-working sites). Depending on density of vegetation we can apply slower but precise point measurements, in more open areas

of forest we can also apply on limited areas successful continuous measurements by Cs-magnetometers. By the same geophysical equipment we can also identify other production areas or features. The survey of the forested area of a medieval pitch-production centre near Rynartice, distr. Děčín helped to identify the most magnetic parts of terrain elevations within massive layers of burned ashes (Fig. 3). Subsequent archaeological excavation by P. Lissek uncovered a pitch furnace with high burned clay materials and also partly stony construction of furnace of neovolcanic material.

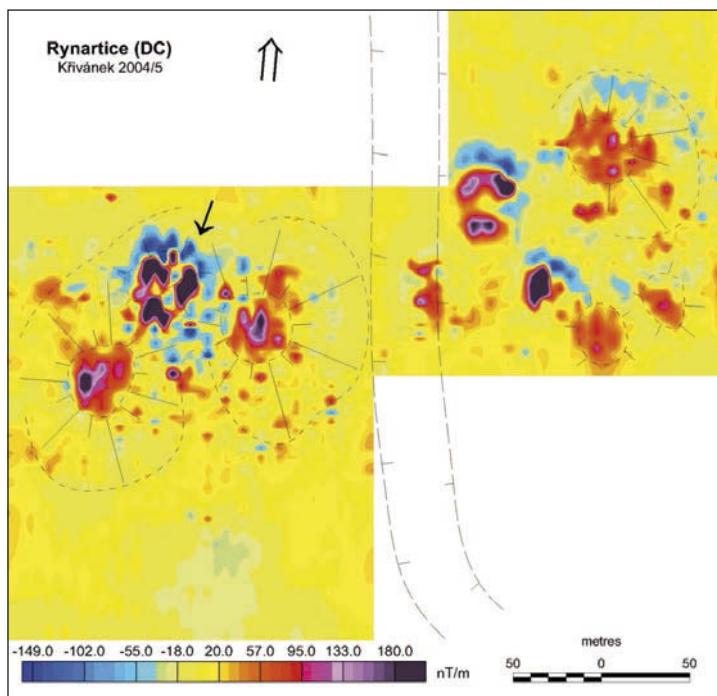

Fig. 3. The combination of results of magnetometric prospecting with detailed field surface survey at forested medieval pitch-production site near Rynartice (surveyed area approx. 0.1 ha).

Magnetometric surveys in forested terrains of archaeological sites can be carried out at suitable non-vegetation time in suitable, often smaller areas outside the steep slopes and modern landscape changes. It is clear that the speed of this survey cannot be the same as in case of arable fields, and depends on the type of vegetation and need of cleaning of lower vegetation and bottom boughs of trees. In case of magnetometric surveys in forested areas it is necessary to calculate with more risks of measurement errors and longer time for processing of data. The field results can also be locally influenced by terrain or geological changes or variable speed of measurement, which can complicate local filtering of data and interpretation of results. But generally atomic magnetometer with continuous measurement can be applied in conditions of different forested archaeological sites. On the other hand, some particular results from these sites show that some forested archaeological terrains could offer better subsurface state of preservation of archaeological situations.

REFERENCES

- Křivánek 2004* R. Křivánek: Geophysical survey in the archaeologically uninvestigated parts of Czech oppida. Antiquity - Project Gallery (<http://antiquity.ac.uk/ProjGall/krivanek/index.html>).
- Křivánek 2005* R. Křivánek: Geophysical survey in the archaeologically uninvestigated parts of Czech oppida. In: S. Piro (ed.), 6th International Conference on Archaeological Prospection, Rome 2005, 17-20.
- Křivánek/Klír in print* R. Křivánek/T. Klír: Contribution of combination of geophysical methods and detailed field surface survey in study of abandoned medieval village Kersko, Central Bohemia. Computer Applications and Quantitative Methods in Archaeology (CAA) 2007, Berlin, 2-6 April - abstract (in print).

Roman Křivánek
Institute of Archaeology of the Academy of Sciences of Czech Republic
Letenská 4
CZ-118 01 Prague 1, Czech Republic
krivanek@arup.cas.cz

THE COMBINATION OF MAGNETOMETRIC PROSPECTION AND OTHER NON-DESTRUCTIVE SURVEY METHODS OF A LARGE LA TÈNE SITE NEAR NĚMČICE, CENTRAL MORAVIA. PRESENT RESULTS AND FUTURE POSSIBILITIES

Roman Křivánek - Miloš Čížmář

Key words: magnetometric survey, Celtic coin, La Tène settlement, production feature, archaeological monument

The Late La Tène settlement near the border of cadastres NĚmčice nad Hanou and Víceměřice has been known from archaeological finds since the early 20th century. But the real significance of site as a La Tène trading and industrial centre has been recognised since 2000 due to amateurs and their surface artefact collection and metal detector prospection. These amateur activities finally brought archaeologists (and museums) approx. 420 coins, 1500 bronze fragments, over 100 iron finds, 380 glass bracelet fragments and 550 glass beads. Presence of various coins (mainly autochthonous but also allochthonous Celtic and other ancient coins from SW, southern and SE Europe and from North Africa) helped to the dating of this centre to the period from the end of the LT B2 to the LT C2, i.e. from the end of the 3rd century to the end of the 2nd century BC (Čížmář 2005; Čížmář/Kolníková 2006).

The systematic non-destructive investigations of this unprotected and ploughed out site have been undertaken by aerial and geophysical prospection since 2002. Subsequent magnetometric measurements of chosen parts of locality were then, in 2004-2006, incorporated to a project supported by the Grant Agency of the Czech Republic („A new La Tène industrial and trading centre in Moravia“, no. 404/04/0118, Čížmář et al. 2004-2006). The field magnetometric measurements of all areas were undertaken by gradient variant of caesium magnetometer (Smartmag SM-4G, Scintrex) in a square grid net 50x50 m with density approx. 1x0.2-0.25 m. The same N-S oriented grid net was also used for subsequent surface artefact collection and for metal detector surveys. The same grid net offered possibility of comparing magnetometric field data with density and concentration of archaeological finds.

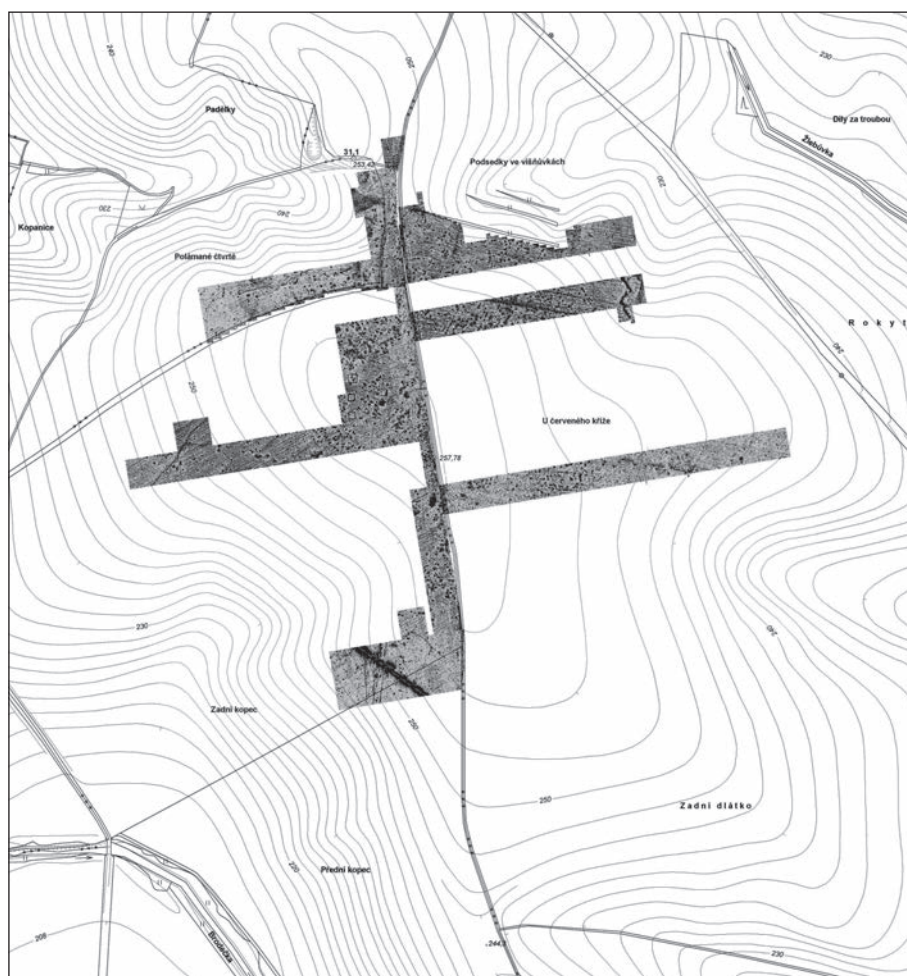

Fig. 1. The overall results of magnetometric prospection near NĚmčice combined with contour line map (surveyed area approx. 21.4 ha).

The main aims of geophysical survey of this extremely large locality were to study the extent and character of the settlement, confirm the assumed production features and identify possible fortification of locality. Results also showed that magnetometric measurements of various sloped arable fields could contribute to better understanding of erosion processes on the site. During 5 years of prospection (2002-2006) there were surveyed approx. 21.4 ha but this area probably still represents only a smaller part of the whole locality. From the overall results of magnetometric prospection (Fig. 1) we can assume that only the extent of the most used plateau within more concentrated subsurface activities and features covers an area of at least 35-40 hectares. That means that for a full separation of these activities from less intensively used areas we would need to prospect another dozens of hectares. The complete size of the area of La Tène site in use could be also much larger.

Particular magnetometric results brought more detail information about the character of subsurface activities. In central or NE part of the site we can find the highest intensity of settlement. By different amplitudes of magnetic anomalies we can separate less magnetic probable sunken features from more magnetic probable production features (*Křivánek 2006*). For the same areas (with concentrated higher magnetic anomalies) results from surface artefact collection and metal detector survey are the highest concentration of bronze finds, slag, coins or glass fragments or beads. It seems that these areas could very probably indicate local metallurgical, coin or glass production. In some places of these intensive activities we can identify non-fortuitous order within some main orientation of groups of features NE-SW or NW-SE (Fig. 2). Together with many sunken settlement and production features (or features with burned materials) we identified at the same area also one smaller and narrow oval (or subrectangular) ditch enclosure. The indication of possible perimeter ditch fortification of site (without possibility of dating) was identified only in one place, approx. 400 m east of the central part of locality. Presence or absence of fortification of La Tène site remains unclear.

Archaeological situation was different in central and highest area of the plateau and the whole site. There were three separated small and closed square ditch enclosures oriented in similar distances N-S (with similar dimensions from 10x10 m to 15x15 m) and one other, probably closed ring ditch enclosure with central sunken feature. In the central part of the site, funeral activity was documented with ploughed out barrows or flat graves with perimeter enclosure (Fig. 3). Only future archaeological excavation could bring exact dating of these funeral features to La Tène or to older prehistoric periods (for example Eneolithic finds known also from surface artefact collection). For southern or western part of the site are typical smaller groups of concentrated features with more empty surrounding zones. In outer parts of the site were indicated ploughed out remains of possible narrow ditch enclosures (unclear dating) and other linear remains of probable extinct field paths.

The whole area of the site near NĚmčice lies on arable fields with large plateau bordered by more sloped terrains. This terrain conditions could be, from the point of view of archaeological prospection, advantageous for future extensive magnetometric survey of another promising areas of the site. The La Tène site near NĚmčice is unfortunately still an officially unprotected archaeological monument without precisely known extent of the whole site. Magnetometric measurements should concentrate on separation of the most intensive settlement, production or funeral activities but also on verification of outer zones within potential remains of fortification or other ditch enclosure systems. The same field conditions are unfortunately also disadvantageous as for the intensive soil erosion and local accumulation. Wide open arable fields of the site are also continuously endangered by illegal metal detector prospectors without possibility of change of agricultural use of private fields. Archaeologists in the region hope that this unique La Tène site will soon be declared as protected archaeological monument by the Ministry of Culture of the Czech Republic.

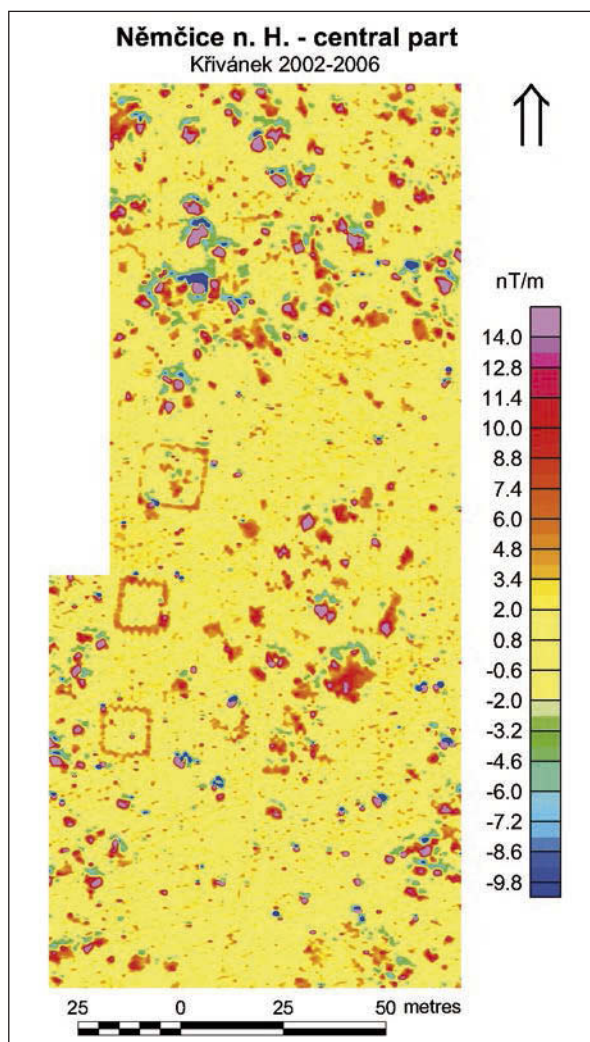

Fig. 2. The identification of different magnetic anomalies in the NE part of the site, separation of probable sunken settlement and production activities and some linear orientation in groups of features (detail of area approx. 5 ha).

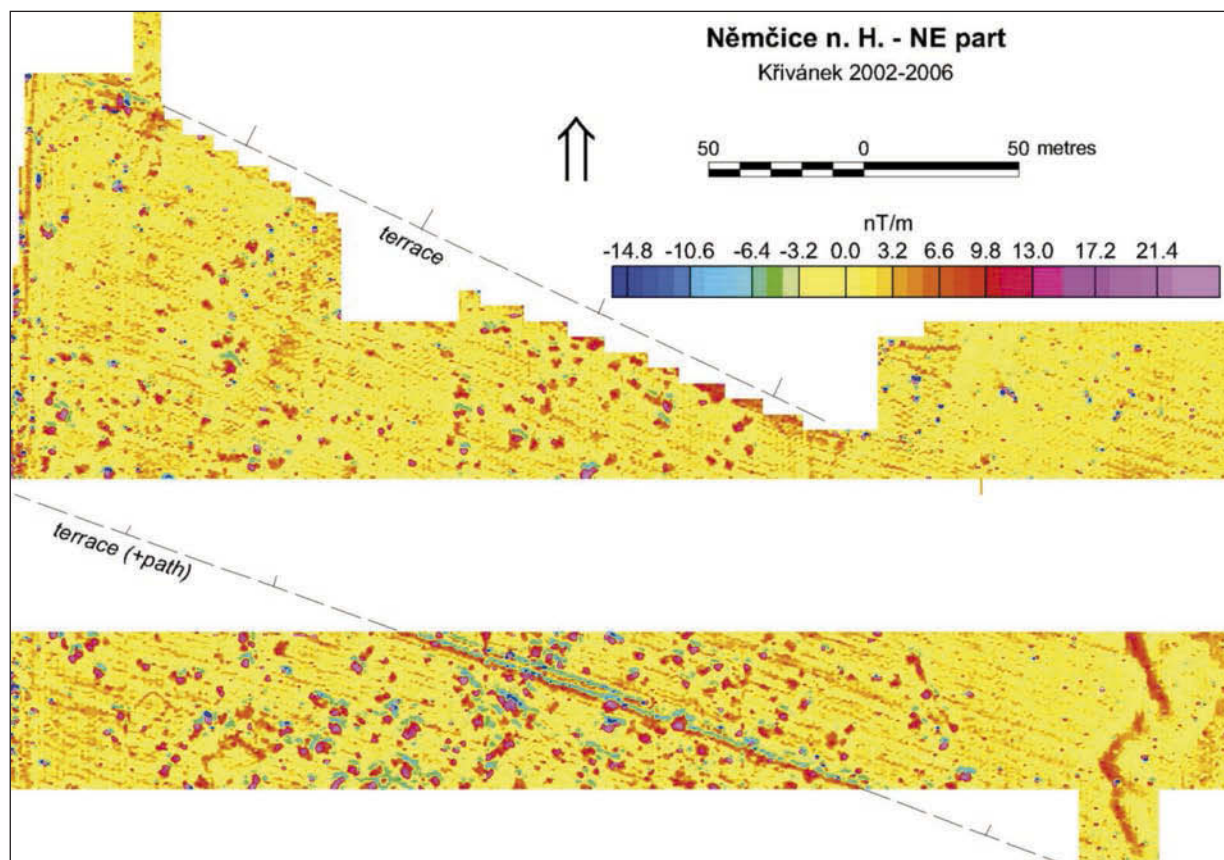

Fig. 3. The identification of probable funeral activities in the central and highest plateau of the site, separation of 3 small and closed square and one other, probably a closed ring ditch enclosure (detail of area approx. 2 ha).

REFERENCES

- Čižmář 2005
M. Čižmář: Nové doklady jižních vlivů v době laténské na Moravě - Neue Belege südlicher Einflüsse in der Latènezeit aus Mähren. In: Južné vplyvy a ich odraz v kultúrnom vývoji mladšieho praveku na strednom Dunaji, Bratislava 2005, 99-105.
- Čižmář/Kolníková 2006
M. Čižmář/E. Kolníková: Němčice - obchodní a industriální centrum doby laténské na Moravě - Němčice - a La Tène trading and industrial centre in Moravia. Archeologické rozhledy LVIII, 2006, 261-283.
- Křivánek 2006
R. Křivánek: Shrnutí výsledků geofyzikálních měření ARÚ Praha na moravských archeologických lokalitách sledovaných ve spolupráci s moravskými archeology (2000-2005) - Summary of results of geophysical measurements of Institute of Archaeology in Prague at moravian archeological sites surveyed in cooperation with moravian archaeologist in 2000-2005. In: V. Hašek/R. Nekuda/M. Ruttkaý (eds.), Ve službách archeologie VII, Brno 2006, 77-92.

Roman Křivánek
Institute of Archaeology
of the Academy of Sciences of Czech Republic
Letenská 4
CZ-118 01 Prague 1, Czech Republic
krivanek@arup.cas.cz

Miloš Čižmář
Institute for Management of Archaeological Heritage
Kaloudova 30
CZ-614 00, Brno, Czech Republic
cizmar@uapp.cz

ON THE USE OF SATELLITE IMAGERY IN ARCHAEOLOGICAL CONTEXT: A COMPREHENSIVE REVIEW

Rosa Lasaponara - Antonio Lanorte - Rosa Coluzzi - Nicola Masini

Key words: remote sensing, imaging, GIS

During the last century, aerial photos have been the most common remote sensing data source used for the study of ancient landscape. More recently, the application of satellite imagery can fruitfully aid the identification of large-scale cultural features, such as ancient land use patterns, roads, irrigations networks, paleohydrological systems. In particular, the recent availability of Very High Resolution (VHR) satellite images, such as IKONOS (1999) and QuickBird (2001), may provide new perspectives in the field of archaeological prospection ranging from small details (single building) to landscape archaeology analyses which involve investigations of large areas. Compared to aerial photo, the VHR satellite data can be promptly geo-referenced, offer a very large coverage, are available at lower costs and for a wider spectral range. The VHR satellite imagery could be ideal for investigations on regional scale as well as for studies performed in areas where aerial photography is restricted because of military or political reasons. Nevertheless, the possibility of locating unknown individual sites as well as large scale cultural features is highly dependent on many factors, such as the image spatial resolution, extension of buried sites, ground characteristics, illumination conditions. The practical potential of satellite-based approaches needs to be tested in relation to the specific archaeological problems of individual regions.

This paper provides a review of satellite, Landsat, Ikonos, and Quickbird data successfully applied in the archaeological context from site identification to landscape archaeology analyses.

Rosa Lasaponara
Antonio Lanorte
Rosa Coluzzi
Istituto di Metodologie per l'Analisi Ambientale
IMAA-CNR, C. da S. Loja
85050 Tito Scalo (PZ), Italy
lasaponara@imaa.cnr.it

Nicola Masini
Istituto Beni Archeologici e Monumentali
IBAM-CNR, C. da S. Loja
85050 Tito Scalo (PZ), Italy
n.masini@ibam.cnr.it

COMPUTER-ASSISTED GPR DATA INTERPRETATION

Jürg Leckebusch - Andreas Weibel - Flurin Bühler

Key words: GPR, semi-automatic interpretation, feature extraction, three-dimensional, regression

Ground-penetrating radar (GPR) is an excellent prospection technique because it provides three-dimensional information about the underground. Unfortunately, the display and interpretation of these data sets is still a difficult task. The first results were presented in the form of profiles, later as time- or depth-slices (Nishimura/Kamei 1991) and more recently by using alpha-blending or even iso-surfaces (Leckebusch/Peikert 2001). In the next step, it was attempted to use local iso-surfaces to better adapt to local conditions (Leckebusch et al. 2001). All these techniques only provide a better view of the data; some require special and expensive hardware or a large amount of computing power. Unfortunately, the problem of understanding and interpreting the data cube is not resolved.

Concept

The new idea is to combine visualisation and interpretation in one single step. In general, the user can easily recognize some structures in the 2-D data. This information can be used as starting point for software to extract the complete 3-D geometry automatically and display it in a three-dimensional view.

Similar systems exist for medical applications. Careful analysis of the GPR data revealed some significant differences to the medical data: The signal-to-noise ratio of GPR data is very low and varying considerably inside a single data set. Additionally, the reflections of a single structure are not constant at all. Finally, the sampling interval along the three coordinate axes is different. Some of these problems can be overcome if relative amplitudes are used. The complete data cube has to be converted from the measured signal amplitudes to the reflection strength first.

The question is now how to model the detected structures. We decided to use a surrounding box composed of six planes. This represents an adequate model for walls, floors, pipes or even ditches, the most frequently found anomalies with GPR.

Pre-processing

As mentioned above, the reflection strength of each trace has to be calculated, and all profiles combined into a 3-D data cube.

Pre-filtering

Tests with different local and global filters have shown that the combination of median filter - dilation - erosion produces the best results (Heincke et al. 2006). This pre-filtering sequence reduces the background noise and thus preserves and enhances the relevant structures. For good results, the filter sizes have to be adapted to the dimensions of the searched structures and used sampling intervals. Finally, a 3-D gradient is calculated, and all features should now have high amplitudes along their boundaries.

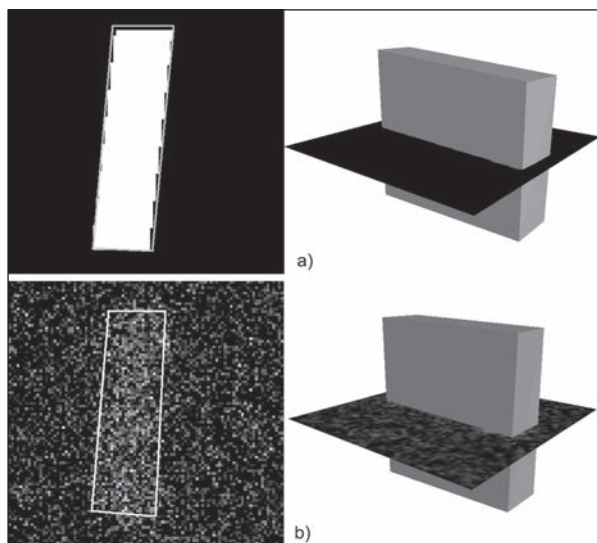

Fig. 1. Semi-automatic feature extraction verified by synthetic data sets, shown with a depth-slice and as a 3-D display. Data cube a. with perfect structure and b. with Gaussian noise (SNR of one to one) added.

Feature extraction

The main process is started by the user, who has to define a starting line on a depth-slice of the data cube. The advantage of this is that only the surrounding area has to be loaded and treated. Therefore, there is almost no limit of the size of the data set that can be processed. At the same time, the necessary computing time can be significantly cut down.

Basically, either Hough transforms (Leavers 1992) or regression-based methods (Meer et al. 1991) can be used to fit planes to three-dimensional data. The former one has already been used to detect linear objects like pipes, but it is difficult to extend the method to more complex objects. Furthermore, the Hough transform quickly becomes unstable in the presence of noise, and the parameter space grows uncomfortably big when it is extended to three dimensions. Because regression methods do not lack these problems and are relatively robust,

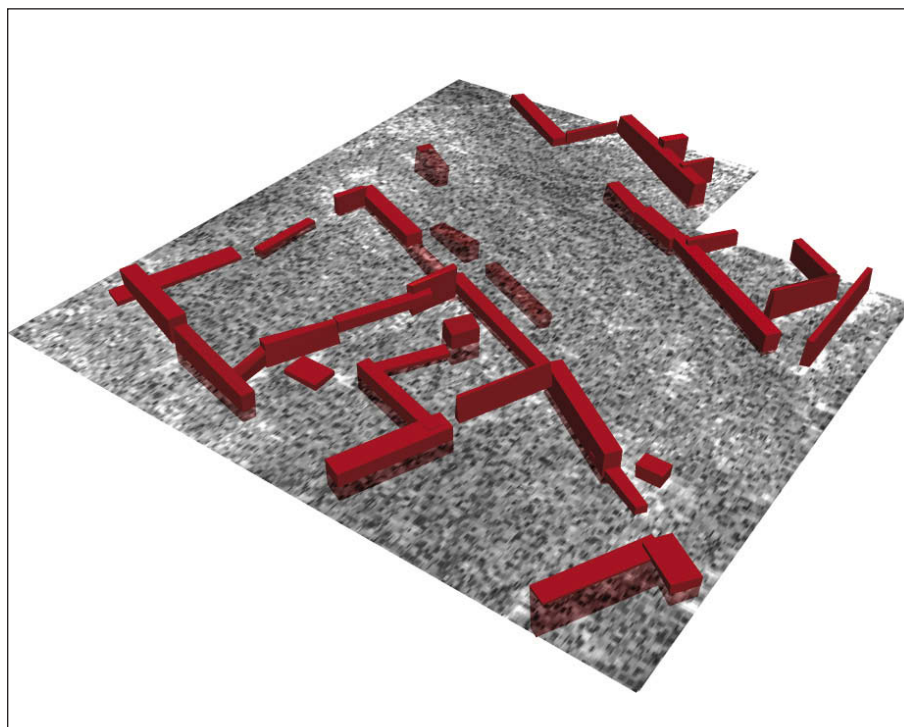

Fig. 2. Computer-assisted interpretation of real survey data. The structures are properly and easily extracted in 3-D by the designed processing sequence. A depth-slice is displayed transparently as reference. Dimensions: 20 x 21.5 m.

a least-median-of-squares method (LMedS) is used to fit the planes to the point cloud. Unfortunately, the geometry of the planes is sometimes suboptimal. Constraining the planes to be perpendicular or parallel to each other to some extent made the feature detection much more reliable.

Display

The extracted three-dimensional objects are finally displayed in a 3-D environment. All other relevant data are already in a GIS and therefore the display and storing capabilities of these software packages are used as front-end. The features can also be exported as a 3-D DXF-file facilitating data exchange with other users.

Examples

The designed processing sequence was first tested on synthetic data sets and proved to be very efficient, even in the presence of a signal to noise ratio of 1 to 1 (Fig. 1). The detection of a standard structure such as a wall took about one second on a modern PC, making it suitable for routine application.

The semi-automatic interpretation was successful in extracting the three-dimensional geometry of different Roman sites, including a town (Fig. 2) and a water channel. As expected, strong modern disturbances posed no problems and even data sets with severe positioning errors were easily handled. To be successful, the technique only requires proper sampling of the structures, i.e. the cross-line sampling must be dense enough.

REFERENCES

- Heincke/Green/van der Kruk/Willenberg 2006* B. Heincke/A. G. Green/J. van der Kruk/H. Willenberg: Semblance-based topographic migration (SBTM): a method for identifying fracture zones in 3D georadar data. *Near Surface Geophysics* 4, 79-88.
- Leavers 1992* V. F. Leavers: Shape Detection in Computer Vision using the Hough Transform. London 1992.
- Leckebusch/Peikert 2001* J. Leckebusch/R. Peikert: Investigating the true resolution and three-dimensional capabilities of ground-penetrating radar data in archaeological surveys: Measurements in a sand box. *Archaeological Prospection* 8, 29-40.
- Leckebusch/Peikert/Hauser 2001* J. Leckebusch/R. Peikert/M. Hauser: Advances in 3D visualization of georadar data. *Archaeological Prospection. 4th International Conference on Archaeological Prospection, Vienna 2001*, 143-144.
- Meer/Mintz/Rosenfeld/Kim 1991* P. Meer/D. Mintz/A. Rosenfeld/D. Y. Kim: Robust regression methods for computer vision: A review. *International Journal of Computer Vision* 6, 1991, 59-70.
- Nishimura/Kamei 1991* Y. Nishimura/H. Kamei: A study in the application of geophysical prospection. In: E. Pernicka, G. A. Wagner (eds.), *Archaeometry* 90, Heidelberg 1991, 757-765.

Jürg Leckebusch
Andreas Weibel
Flurin Bühler

terra vermessungen ag
Obstgartenstrasse 7
CH - 8006 Zürich, Switzerland
leckebusch@terra.ch

LARGE SCALE GPR SURVEYS IN AUGST

Jürg Leckebusch - Hans Sütterlin

Key words: GPR, data processing, documentation

During the last years, several geophysical prospections with ground-penetrating radar were done on the site of the Roman town of Augusta Raurica, today called Augst in Switzerland. All the work was done in direct relation to archaeological projects. The possible range of application of the method is illustrated by these surveys: In some cases the prospection was done in advance of the excavation to have a better basis for planning. Other areas were surveyed for documentation purposes and to complete the archaeological monument records. The technique was able to show the structures in the surrounding area of excavations and hence to answer questions from the excavations.

The data were recorded with an in-line spacing of 0.025 m and a cross-line spacing of at least 0.25 m. Tests and theoretical considerations show (*Doerksen 2002*) that a coarser cross-line spacing leads to aliasing and would therefore result in degraded data quality. Two 400 MHz or two 500 MHz antennas, mounted on a vehicle, were used to survey the areas (Fig. 1). Such a configuration allowed covering of more than 10.000 m² a day, which makes the speed of the field recording comparable to standard magnetic surveys.

It was the aim of the data processing to provide the best possible results for archaeologists. Therefore, the following processing sequence was applied: At the first stage, the electronic noise was removed from the data. Several other disturbances like noise bursts and spikes had to be eliminated afterwards (Leckebusch 2003). It is important that these steps are applied before rubber banding or binning, because the latter would otherwise smear out the disturbances. After determination of a proper velocity function by constant velocity migration tests (Leckebusch 2000), the datasets were migrated and converted from time to depth. In case of a significant undulation of the terrain, a static shift according to the topography was applied. As it is difficult to fully understand the data cube without experience and special tools, interpretation must be provided for the archaeologist. All anomalies were manually converted to vector information and coded with the archaeological feature type. As the height information was extracted together with the geometry, pull-up corrections became possible to further correct the imaging problems (Leckebusch *in print*).



Fig. 1. Quad with two GPR antennas and prism for the real-time positioning system, used to survey the areas.



Fig. 2. Plan of the Roman site Augusta Raurica with the interpretations of the ground-penetrating radar data in colour and the already excavated structures in black.

All the results from the ground-penetrating radar provided a detailed insight into the Roman town and helped to complete the map of the ancient town (Fig. 2).

REFERENCES

- Doerksen 2002* K. Doerksen: Improved optical positioning for GPR based structure mapping. GPR 2002, Ninth International Conference on Ground Penetrating Radar, Santa Barbara, CA, 2002, 503-507.
- Leckebusch 2000* J. Leckebusch: Two- and three-dimensional georadar surveys across a medieval choir: A case study in archaeology. *Archaeological Prospection* 7, 189-200.
- Leckebusch 2003* J. Leckebusch: Ground-penetrating radar: a modern three-dimensional prospecting method. *Archaeological Prospection* 10, 213-240.
- Leckebusch in print* J. Leckebusch: Pull-up/pull-down corrections for GPR data. *Archaeological Prospection* in print.

Jürg Leckebusch
terra vermessungen ag
Obstgartenstrasse 7
CH - 8006, Zürich, Switzerland
leckebusch@terra.ch

Hans Sütterlin
Ausgrabungen Augst und Kaiseraugst
Poststrasse 1
CH - 4302, Augst, Switzerland
hans.suetterlin@bl.ch

GEOPHYSICAL EVIDENCE FOR ASSESSING PLOUGH DAMAGE

Neil Linford - Paul Linford - Louise Martin - Andrew Payne

Key words: GPR, plough damage

Geophysical survey provides a rapid and non-invasive means for locating and identifying buried remains, which has often been used as a qualitative tool to assess the survival of underlying archaeological features on plough-threatened sites. Recent developments have seen an increased application of Ground Penetrating Radar (GPR), allowing a more detailed image of the subsurface to be drawn, including the variation of geophysical response with depth. Results from an arable site at Dunkirt Barn, near Andover, Hampshire, located Roman building remains through an initial combination of caesium magnetometer and earth resistance survey to complement known, but poorly recorded, antiquarian excavations and aerial photographic evidence.

Subsequent high sample density GPR (over a total area of 2.6 ha) revealed clouds of individual point source reflectors in the very near surface data between 0 and 10ns (effectively from the ground surface to a depth of ~0.3 m) which, from the resolution of the 450 MHz centre frequency antenna used for the GPR survey, are likely to be caused by targets at least 0.1 m in size (Fig. 1: A). These dimensions would match the fragments of plough damaged building remains, mainly large flint nodules from the rammed chalk and flint walls of the underlying villa, observed in the topsoil during the survey. This dense cloud of debris has, perhaps, masked the deeper buried archaeology and therefore restricted the use of aerial photographs for identifying building remains at this site (Fig. 2).

This data was then used to provide a semi-quantitative estimate of the volume of displaced building material in the topsoil compared to the surviving wall footings at a depth beyond the reach of the plough (Fig. 1: B). These results not only provide a highly visual demonstration of the threat posed by ploughing but also the potential, through repeat GPR survey, to allow the degree of attrition through mechanical agriculture to be assessed over time.

The survey at Dunkirt Barn demonstrates that where appropriate masonry building remains exist, high resolution geophysical survey can provide a means to identify prevailing patterns of plough damage and indicate the depth to which the archaeology is threatened. Such information could in future assist in developing appropriate mitigation strategies to protect vulnerable archaeology, perhaps being deployed in advance of, or alongside the use of physical markers in the soil.

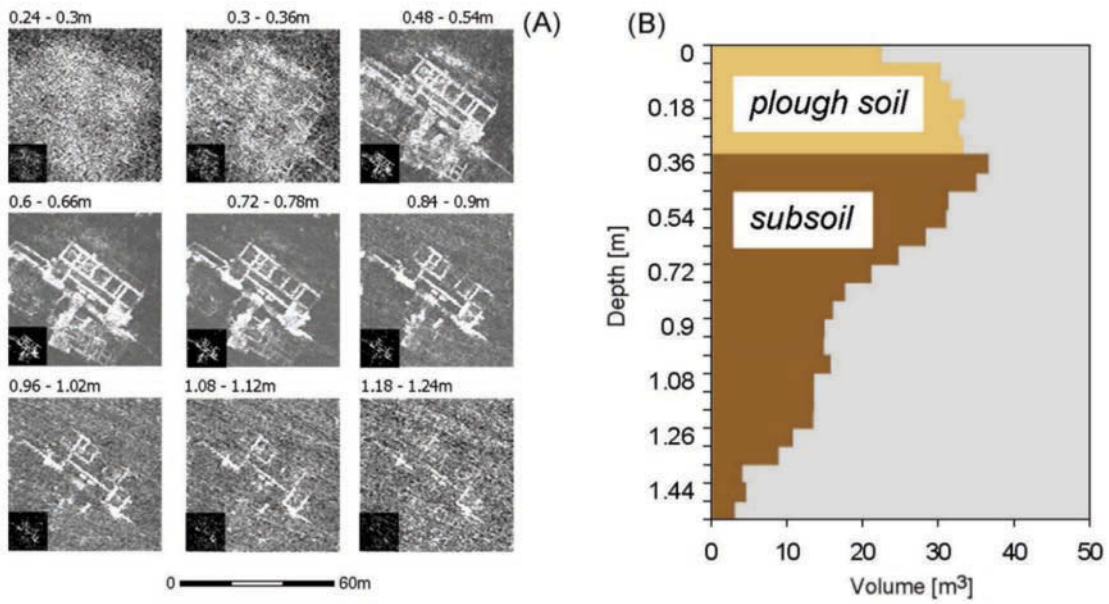

Fig. 1. Selected amplitude time slices from the GPR survey over the main villa building illustrating the “cloud” of plough damaged building material present within the topsoil. Archaeological remains appear to be well preserved below a depth of approximately 0.5 m. Inset images within the individual GPR time slices show the reduced Boolean data sets used to estimate (B) the volume of plough damaged material in the topsoil and the total volume of building remains visible to the GPR.

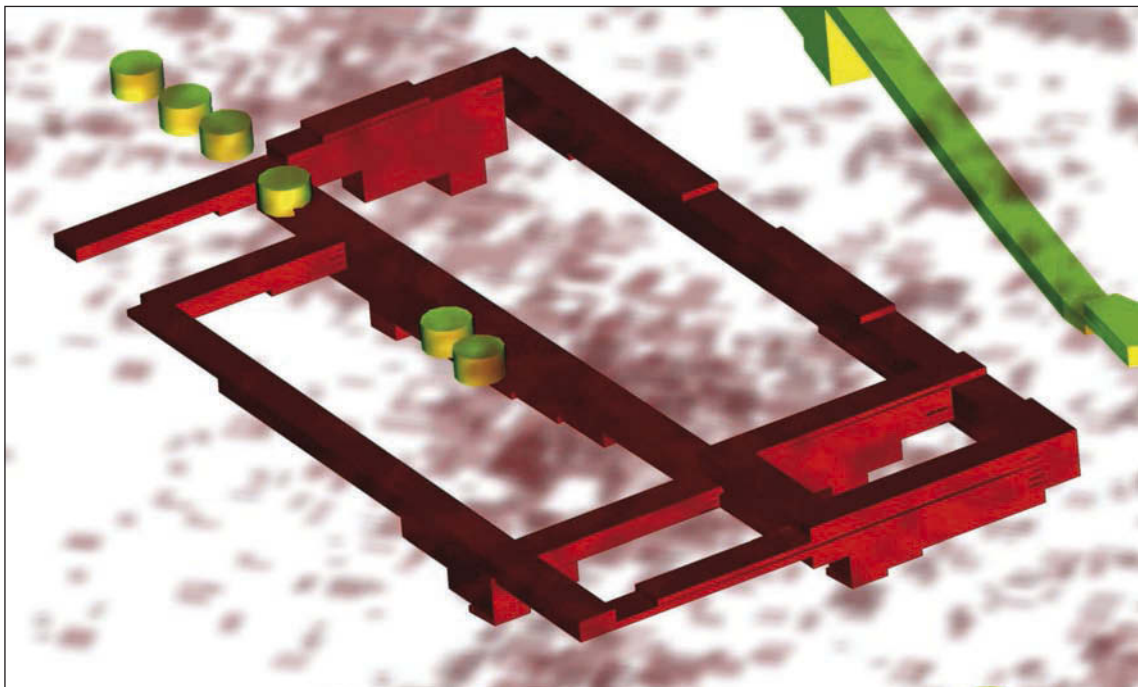

Fig. 2. 3D interpretation of a plough damaged Roman building drawn from the GPR data collected at Dunkirt Barn. The cloud of displaced building material in the topsoil is shown as a semi-transparent bitmap image superimposed over the solid model of the surviving remains (vertical axis exaggerated x 3).

Neil Linford
 Paul Linford
 Louise Martin
 Andrew Payne

Fort Cumberland, Eastney, Portsmouth
 PO4 9LD, United Kingdom
 Neil.linford@english-heritage.org.uk
 paul.linford@english-heritage.gov.uk
 Louise.Martin@english-heritage.org.uk
 Andy.Payne@english-heritage.org.uk

**PERFORMANCE EVALUATION OF EDGE DETECTION ALGORITHMS
FOR THE DETECTION OF ARCHAEOLOGICAL FEATURES BY USING SATELLITE DATA****Nicola Masini - Rosa Coluzzi - Antonio Lanorte - Rosa Lasaponara***Key words: satellite imagery, high resolution*

The recent availability of Very High Resolution (VHR) satellite imagery, such as IKONOS (1999) and QuickBird (2001), may be able to open new perspectives in the field of archaeological remote sensing. In particular, QuickBird offers panchromatic and multispectral imagery with the highest spatial resolution currently available within the satellite sensors. It has panchromatic and multispectral sensors with spatial resolutions (SR) of 61-72 cm and 2.44-2.88 m, respectively, depending upon the off-nadir viewing angle (0-25 degrees).

The high spatial resolution and spectral capability can make the VHR satellite images a valuable data source for archaeological investigation ranging from synoptic view (i.e. identification of high probability locations of ancient buried sites) to small details (i.e. single subsurface building).

Nevertheless, the satellite-based detection of archaeological marks faces several challenges, particularly in the case of buried remains. In fact, the presence of underlying structures produces weak signals that can be easily covered by noise. Responses from true features and those from noise can not be distinguishable. This kind of problem could be reduced using suitable edge detection algorithms, which allow the enhancement of spatial features, so facilitating their identification.

The most common edge detection algorithms were tested in this paper in order to evaluate their performance for the detection of archaeological features. The evaluation is performed by using satellite QuickBird imagery acquired for some study cases located in the South of Italy.

Flow chart of the procedure adopted for the identification of archaeological marks.

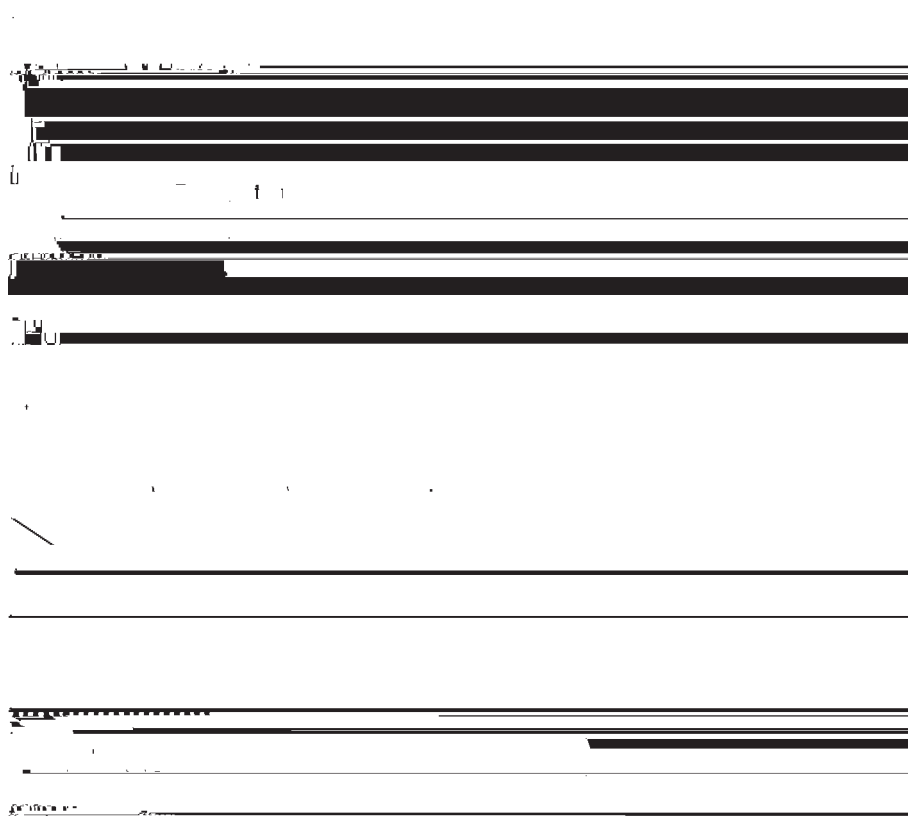

Rosa Lasaponara
Antonio Lanorte

Rosa Coluzzi
Istituto di Metodologie per l'Analisi Ambientale
IMAA-CNR, C. da S. Loja
85050 Tito Scalo (PZ), Italy
lasaponara@imaa.cnr.it

Nicola Masini

Istituto Beni Archeologici e Monumentali
IBAM-CNR, C. da S. Loja
85050 Tito Scalo (PZ), Italy
n.masini@ibam.cnr.it

GIS Project of the Cyrenaican Valleys (Libya)

Oliva Menozzi

Key words: GIS, remote sensing, intensive field survey, mapping, landscape archaeology

Since 1997, the team of Chieti University has been mapping the area around ancient Cyrene, a rich Greek colony, Romanised in the 1st century BC, centrally located on the fertile Jebel Akdar (Green Mountain) in eastern Libya. The aim of our project is the survey and mapping of the valleys around this Greco-Roman town, in order to understand the mechanisms of exploitation and settling of this territory in antiquity.

The region has been investigated at different levels of intensity of the field survey. At a wider level the main sites, structures, villages and scatters have been mapped with a judgemental typology of survey. Moreover, two transects have been chosen for a more intensive survey. The data coming from the numerous past seasons have been collected in a Geo-database which represents the focal point of our GIS project. As topographic base of the GIS, high definition B/W and Col. images have been used, after their hortoerectify and georeference, in combination with a cartographic base at detailed scale. The database was developed under Access XP that is easily interacting with ArcMap and also is more suitable for import-export of the information from different software. Therefore, thanks to our database, we can make a digital elevation model, useful to make a general plot of our main sites and a general GIS of the region, recording the main archaeological sites, investigated only with a preliminary judgmental survey that gave us a general idea of the archaeological landscape in order to individuate one or more transects for a more intensive survey. The surveys and the excavations have been integrated by Remote sensing of the satellite images and of the aerial photos. Therefore, the GIS represents the combination of all the data coming from different levels and typologies of research and scientific approaches.

Among the preliminary finds in the first seasons of the survey we analysed rocky sanctuaries located in the widian around the town, which were extremely important in Greek times as religious boundaries where Greeks and natives could meet and interact. For Roman and Late Roman periods, the main archaeological evidence that attracted our attention was the quantity of fortified settlements, which are locally named Gsur. In these sites they are often characterised by the presence of oil and wine presses, cisterns, which made them crucial for understanding of the economy

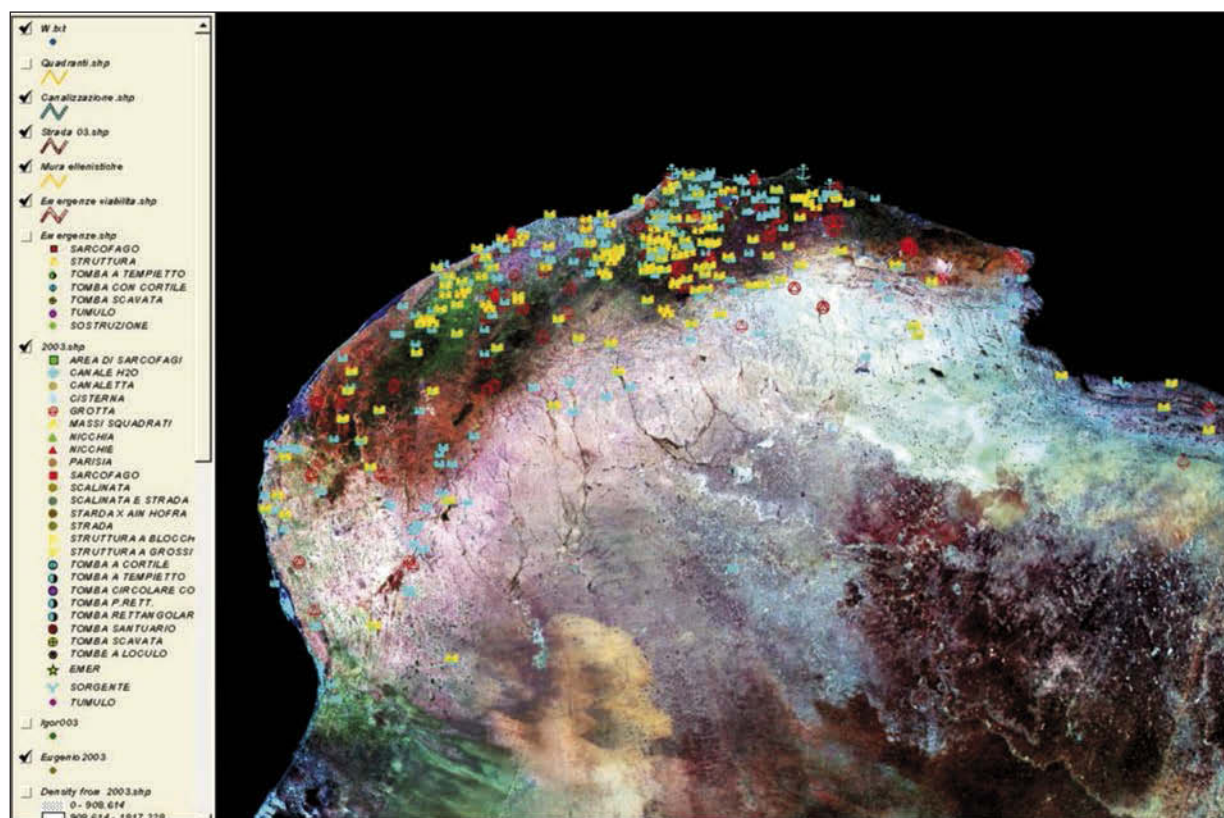

Fig. 1. GIS of Cyrenaica, with the main fortified settlements, villages, towns and indication of the main valleys, on a landsat mosaic satellite image used as a base.

and agricultural exploitation of this territory. Moreover, the area is intensively characterised by numerous tombs widespread around Cyrene, which represent the most spectacular necropolis of the Mediterranean basin. The survey of these tombs has been organised for areas and is giving interesting results on funerary uses and architecture from Greek to late Roman times.

The excavations concentrated on one of the transects, known as Wadi Ain Hofra, which is particularly rich in cult chambers relating to a Chtonian Greek Sanctuary, to a later Sanctuary of Zeus Ammon and to numerous rocky tombs located at the margins of these religious sites. Methodologically, the first step of our GIS was to follow the natural division of the area in four sub units. It gave us also the possibility to organise the work easier and to take all the documentation organised "online" and daily printable to see the results of the survey and organise it day by day. Then we decided to combine the two field survey techniques, and combine properly the two very different phases of the work. The first phase is based on a judgemental survey with a preliminary record and documentation of the main archaeological remains. The second phase is based on the intensive survey of the area with an analytic documentation and a high sampling strategy.

At this point of the survey, the use of GPS was important because the topography of the region is characterised by upland plateaux and terraces running parallel to the sea-coast and vertically cut by deep and steep wadian (valleys), which do not allow a homogeneous control of the sampling strategy of the survey. Therefore, we had to test methodology for monitoring and keep constant the sampling strategy, using the tracks of the GPS of each team. In fact, walking with the GPS switched on, and recording the GPS tracks and knowing the number of people working for each team we could easily reconstruct and keep constant the sampling strategy used in the area. The kinds of GPS used by our team are: WAAS GPS for each team and DGPS for corrections and detailed mapping.

As for the progress of our GIS: In the first area we have finished the first phase of the survey, and in the next seasons we will try to finish also the second phase. In the second, the third and the fourth area, we have already finished the two phases of the survey. A preliminary result of the survey of Ain Hofra is that 35% of the remains are coming from funerary contexts and in particular represent the different typologies of tombs. On the other hand we have a 65% of the remains belonging to ancient roads, votive contexts, rural evidence and so on.

In conclusion, we have found different types of archaeological remains, showing that the area was in the centre of religious life of the ancient Cyrene. From the chronological point of view, in the first area, where the survey is still in progress, mainly Late Roman phases concerning small terraced areas used for farming have been attested. In the second area, where the survey has been completed during the last season, mainly funerary monuments are attested, dated to the Hellenistic period and often closely related to remains of roads or walls supporting terraces. The third quadrant, where the survey is finished, presents tombs dated to the fourth century B.C. together with remains of the ancient road network and water channels. Last quadrant presents mainly votive remains, such as niches with Greek inscriptions, and probably dated to the classical period.



Fig. 2. DEM of the territory closest to Cyrene, with the location of the main rocky sanctuaries.

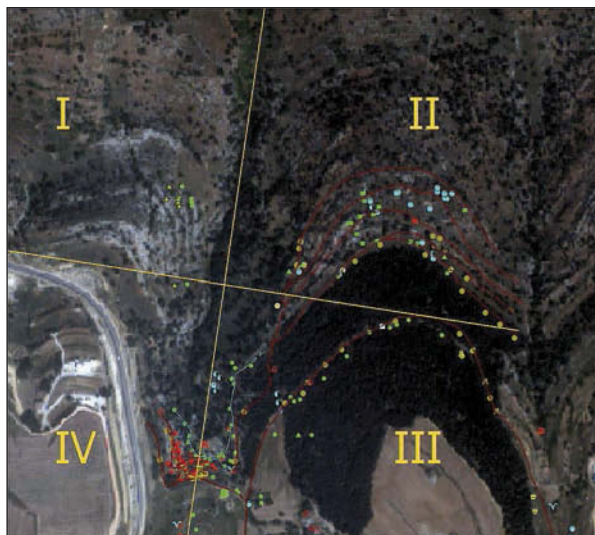

Fig. 3. GIS of Wadi Ain Hofra, with the main sites and the organization of the valley in 4 sub-units.

Oliva Menozzi

Department of Antiquities, University of Chieti
Campus Universitario
66013 Chieti scalo, Italy
o.menozzi@unich.it

ROMAN CENTURIE RECONSTRUCTED BY HYPERSPECTRAL REMOTE SENSING

Pasquale Merola

Key words: remote sensing, archaeology, MIVIS airborne hyperspectral sensors, Roman Centurie, GIS

In the last 20 years the air photograph and the remote sensing, both from airplane and satellite, allowed to gain useful information for the location of archaeological structures, based on the analysis of the superficial land units characteristics

Data acquired by MIVIS (Multispectral Infrared and Visible Imaging Spectrometer) appear to be useful in the plan that CNR Atmospheric Pollution Institute has carried out on several archaeological sites since 1994: Selinunte, Arpi, Villa Adriana, *Sipontum* and *Lilybaeum* (Marsala).

To investigate these archaeological areas, we have analyzed the MIVIS airborne hyperspectral sensors. MIVIS is a modular instrument composed of 4 spectrometers, which simultaneously collect radiation coming from the Earth's surface in the Visible (0.43-0.83 μm), the Near-InfraRed (1.15-1.55 μm), the Mid-InfraRed (2.0-2.5 μm), and the Thermal-InfraRed (8.2-12.7 μm), a total of 102 spectral bands.

The MIVIS data, which can be enhanced, rectified and reclassified using several algorithms and specific software, permit the identification of archaeological structures as buried ruins, either of human or natural origin, are affected over time, soil surface characteristics creating anomalies.

These anomalies are due to different factors, such as physical and chemical soil features and vegetation cover status. The above factors are strictly connected and are responsible for surface spectral responses. In particular the spectral response of vegetated areas presents a complex mixture of vegetation, soil brightness, environmental effects, shadow, soil colour and moisture.

MIVIS remote sensing permits to analyse simultaneously a wide range of different wavelengths: the use of the red and near-infrared channels of the MIVIS sensor are particularly useful for the study of cover vegetation.

To highlight the surface anomalies identified in the MIVIS images, due to variations of texture, humidity and vegetation brought about by the presence of buried structures, different hyperspectral data processing procedures were used.

The images, derived as output of different methods, were interpreted from archaeological and topographic points of view. The results have been a number of traces drawn and compared with earlier archaeological findings.

The Roman conquest was accompanied by a complete reorganisation of the territory, divided into many parts called "centurie", which were intensely cultivated and inhabited by Roman farmers. With its road conditions, its drains and its land settlements the Roman Centurie was important to determine economics during the following centuries.



Fig. 1. Lilybaeum (Marsala, Italy). Lineaments considered as relating to the urban scheme, white rectangles indicate the insulae.



Fig. 2. MIVIS images of the archaeological *Sipontum* (Foggia, Italy) area.

The aim of this work is to assess useful information for the recognition of the ancient archaeological traces corresponding to ancient Roman Centurie (a system to divide the territory), in Salento area, Puglia Region (Italy), identified by anomalies due to the textures, humidity and vegetation variations of ground surface and by survival traces (some examples are current roads precisely corresponding to ancient routes).

Archaeological hypotheses get by traditional investigation methods and results obtained by remote sensing approach sometimes do not correspond. The results must be always ascertained directly *in situ*.

Digitalizing the output and inserting these results in GIS (Geographical Information System) environment provided an overlaying of multiple geographic information, useful to place the investigated archaeological areas in its present and over time environmental, social and territorial context.

REFERENCES

- | | |
|--|--|
| <i>Bannari/Morin/Bonn 1995</i> | A. Bannari/D. Morin/F. Bonn: A review of Vegetation Indices, Remote Sensing 13, 1995, 95-120. |
| <i>Bianchi/Marino/Pignatti 1994</i> | R. Bianchi/C. M. Marino/S. Pignatti: Airborne Hyperspectral remote sensing in Italy, Europto, Rome 27-29 September 1994, SPIE V 2318, 1994, 29-37. |
| <i>Cavalli/Pignatti 2001</i> | R. M. Cavalli/S. Pignatti: Il telerilevamento iperspettrale da aereo per lo studio dei Beni Archeologici: applicazione dei dati iperspettrali MIVIS. Remote Sensing in Archeology, XI Ciclo di lezioni sulla ricerca applicata in archeologia. Certosa di Pontignano (Siena), 6-11 dicembre 1999, 2001, 221-232. |
| <i>Cavalli/Merola/Pignatti/Poscolieri 2005</i> | R. M. Cavalli/P. Merola/S. Pignatti/M. Poscolieri: Telerilevamento iperspettrale MIVIS per lo studio delle testimonianze antropiche nell'area archeologica di Arpi (FG). Rivista Italiana di Telerilevamento. 33/34, Firenze 2005, 109-117. |
| <i>Merola 2004</i> | P. Merola: Tecniche di telerilevamento iperspettrale applicate alla ricerca archeologica. Il caso di Lilybaeum (Marsala). Archeologia Aerea. Studi di Aerotopografia Archeologica, Roma 2004, 301-318. |
| <i>Piccarreta/Ceraudo 2000</i> | F. Piccarreta/G. Ceraudo: Manuale di aerofotografia archeologica. Metodologia, tecniche e applicazioni, Italia 2000. |

Pasquale Merola
 CNR Atmospheric Pollution Institute
 V. Salaria km. 29.300
 00016 Monterotondo St., Rome, Italy
 merola@iia.cnr.it

FROM SEARCHING TO 3D IMAGING: GPR ULTRA-DENSE GRID METHODOLOGIES

Alexandre Novo - Henrique Lorenzo - Fernando I. Rial - Manuel Pereira - Mercedes Solla - Pedro Arias

Key words: GPR, 3D imaging, archaeology

Ground-penetrating radar (GPR), especially related to 3D imaging has been increasingly used in archaeological surveys in the last decade due to its resolution. Nowadays, GPR techniques are able not only to find but also to obtain 3D reconstructions of buried objects.

Understanding of GPR results by non-geophysicists has long been a challenge. The huge improvement of 3D imaging and processing software and the application of different dense-grid methodologies in the last years have produced great results.

3D imaging techniques were already successfully applied in GPR surveys (Leckebusch 2003; Nuzzo et al. 2002; Leucci/Negri 2006) at different archaeological sites such as Roman buildings, Japanese burial mounds, etc. These are usually wide areas with large targets that often have a well-known geometry. So usually a space between profiles of 50 cm is used, mid-low frequency antennas and a vast interpolation among data do not matter to obtain valuable time slices that clearly show the shape of those targets.

On the other hand, GPR dense-grid methodologies based on the Nyquist theory are employed to obtain 3D and 4D imaging of the shallow subsurface geometries: sand stratigraphy, tree roots, fractures and fluid flow (Grasmueck

et al. 2004b). The complexity of the targets makes almost impossible to get 3D high resolution images by only applying image processing unless the grid spacing is reduced to $\lambda/4$.

The suitability of GPR in the location of man-made underground masonry (such as galleries or crypts) is already well-known (*Lorenzo et al. 2002; Martinaud et al. 2004*) but a more ambitious study is shown in this paper. The aim of the presented work was to find a sarcophagus and define its shape.

In this GPR investigation in the convent of Santo Domingo (Lugo, Spain) a mudéjar sarcophagus was found where it was not expected to be according to historical records. Moreover, images of its shape were obtained after applying several GPR ultra-dense grids as well as some of the newer 3D imaging techniques.

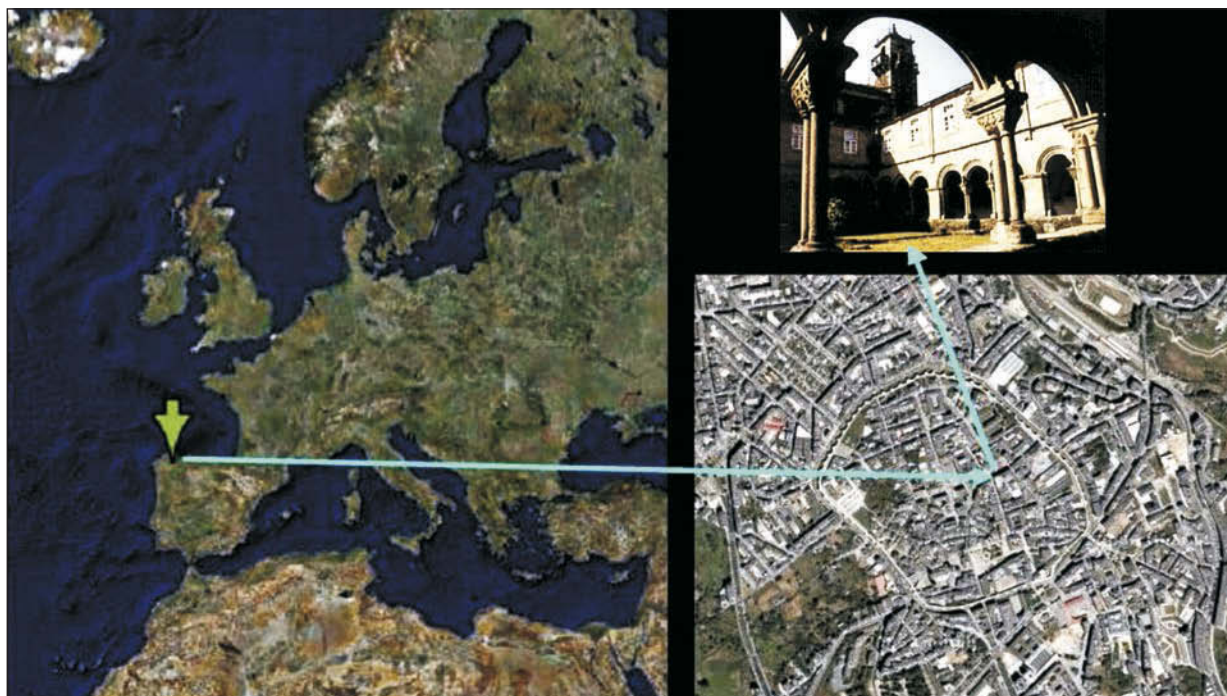

Fig. 1. Situation of the Convent of Santo Domingo in the city of Lugo (NW Spain).

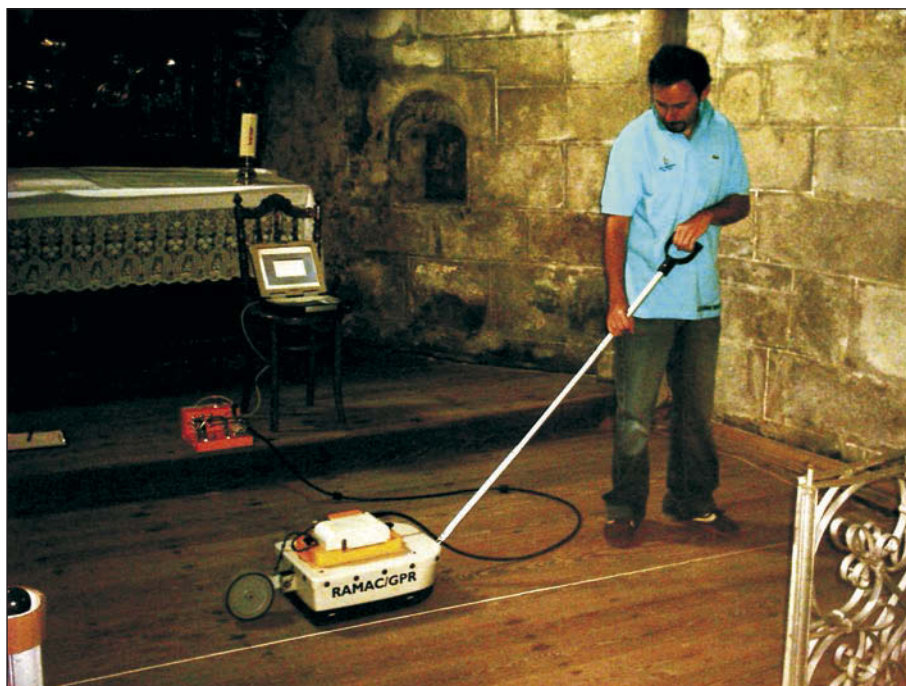

Fig. 2. Ultra-dense grid acquisition inside St Pedro Mártir's Chapel (500 MHz antenna).

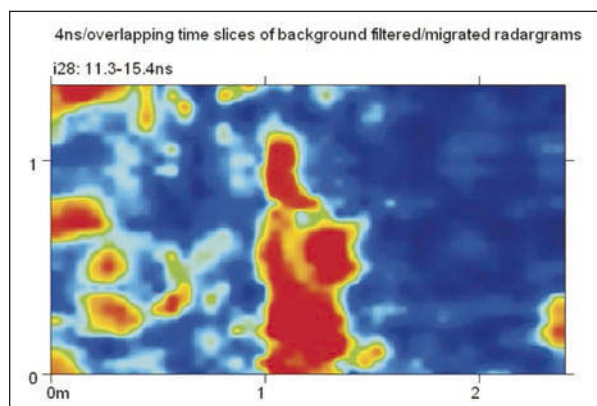

Fig. 3. Time-slice at 11.3-15.4 ns showing a stretched reflector at a depth less than 1 m.

very small grid and the extreme care of the operators. However, a more precise system would be necessary in other field conditions so as to prevent irregular distribution of GPR lines (Grasmueck/Viggiano 2006; Lualdi et al. 2006).

In addition, different software was applied and combined to obtain a large variety of displays and to find the most reliable 3D results. Easy 3D software of Malå Geoscience was used to build rough 3D cubes from raw data in order to rapidly visualise first results and then choose the right data set for deeper processing methods. First depth-slices were created with ReflexW 4.1 software and then enhanced with Surfer8.

A more advanced time slice data analysis was done with GPR-SLICEv5.0 Software. After applying a signal processing flow consisted in manual gain, DC drift removal, background removal and migration, the newer 3D imaging GPR data processing techniques such as: isosurface rendering and overlay analysis offered the best results. Animations, overlapped time-slices, virtual C-scans and isosurface renders have managed to discern the shape of the sarcophagus and to interpret the prospection data easily.

To sum up, intuitive comprehension of data by archaeologists or historians is very useful in most archaeological projects and this is achieved by displaying the GPR data in this manner. Moreover, comparison of the present work with previous searches of other man-made masonry structures such as voids or crypts shows that the application of such a dense methodology combined with a proper 3D imaging process of data is worth it.

REFERENCES

- Goodman 2007
 D. Goodman: GPR-SLICE v5 manual, Geophysical Archaeometry Laboratory, 20014 Gypsy Ln, Woodland Hills, CA 91364, USA. www.gpr-survey.com
- Grasmueck/Viggiano 2006
 M. Grasmueck/D. A. Viggiano: 3D/4D GPR Toolbox and Data Acquisition Strategy for High-Resolution Imaging of Field Sites. Eleventh International Conference on Ground Penetrating Radar. Columbus 2006.
- Lualdi/Zanzi/Sosio 2006
 M. Lualdi/L. Zanzi/G. Sosio: A 3D GPR Survey Methodology for Archaeological Applications. Eleventh International Conference on Ground Penetrating Radar, Columbus 2006.
- Leucci/Negri 2006
 G. Leucci/S. Negri: Use of ground penetrating radar to map subsurface archaeological features in an urban area. Journal of Archaeological Science 33, 2006, 502-512.
- Conyers 2004
 L. B. Conyers: Ground-penetrating Radar for Archaeology. 2004.
- Grasmueck/Weger/Horstmeyer 2004
 M. Grasmueck/R. Weger/H. Horstmeyer: Full-resolution 3D Imaging for Geoscience and Archeology. Tenth International Conference on Ground Penetrating Radar. Delft 2004.
- Martinaud/Frappa/Chapoulie 2004
 M. Martinaud/M. Frappa/R. Chapoulie: GPR signals for the understanding of the shape and filling of man-made underground masonry. Tenth International Conference on Ground Penetrating Radar. Delft 2004.
- Annan 2003
 A. P. Annan: Ground Penetrating Radar: Principles, Procedures & Applications. Sensors & Software Inc, Mississauga 2003.
- Leckebusch 2003
 J. Leckebusch: Ground-Penetrating Radar: A Modern Three-dimensional Prospection Method. Archaeological Prospection 10, 2003, 213-240.
- Nuzzo/Leucci/Negri/Carrozzo/Quarta 2002
 L. Nuzzo/G. Leucci/S. Negri/M. T. Carrozzo/T. Quarta: Application of 3D visualization techniques in the analysis of GPR data for archaeology. Annals of Geophysics 45, 2002.

Lorenzo/Hernández/Cuellar 2002

H. Lorenzo/M. C. Hernández/V. Cuellar: Selected radar images of man-made underground galleries, *Archaeological Prospection* 9, 2002, 1-7.Alexandre Novo
Henrique Lorenzo
Fernando I. Rial
Manuel Pereira
Mercedes Solla
Pedro AriasEscola Universitaria de Enxeñaría Técnica Forestal, Laboratorio de Topografía
Campus a Xunqueira - Universidade de Vigo - A Xunqueira s/n - 36005 Pontevedra, Spain
alexново@uvigo.es**MICROGRAVITY MEASUREMENTS AND GPR TECHNIQUE IN THE SEARCH FOR MEDIEVAL CRYPTS: A CASE STUDY FROM ST. NICHOLAS CHURCH IN TRNAVA, SW SLOVAKIA****Roman Pašteka - Miroslav Terray - Miroslav Hajach - Mariana Pašiaková***Key words: gravimetry, Ground Penetrating Radar, Bouguer anomaly, correction for gravity effect of walls***Introduction**

Detection of cavities is an important task of near-surface geophysics and there exists a great variety of applications of various geophysical methods (in engineering, environmental and archaeological cases). In the frame of a complex study of the history and structure of St. Nicholas church in the city of Trnava (SW Slovakia, approx. 45 km north of Bratislava) detailed geophysical measurements were realized. The aim of this study was the detection of several medieval crypts, which should be located in the interior of the church, but the exact position of which was unknown.

The methods used

Microgravity measurements (by means of Scintrex CG-3M and CG-5 instruments) were realized in a 1×1 m net of points in the accessible parts of the church (Pašteka *et al.* 2006). Results from the measurements were processed into a Bouguer anomaly map with incorporated corrections for the gravity effect of walls (Fig. 1). Modelling of the gravity effects of the surrounding walls was one of the most important steps in the processing of the gravity data - a total number of 18 vertical prisms with polygonal cross-section and density of 1.70 g.cm⁻³ (brick) formed the structure of the walls. Based on the qualitative interpretation, seven important anomalies were recognized as responses of cavities, whose amplitude (from 30 to 50 microGal) and pattern was very close to that of crypts in relatively shallow depths. Quantitative interpretation by means of the 3D density modelling and Euler deconvolution confirmed this information. One of the outputs of the density modeling was the fact that the crypts were filled by air and not water as it was expected by experts from the city government.

Parallel to the microgravity survey a 2D GPR survey in a tracing modification (by means of Mala Easy Locator EXM+ with 500 MHz and 350 MHz antennas) was realized (Terray 2006). All seven crypts were detected (typical case in Fig. 2) and one additional was recognized in a close vicinity of the left-hand side wall of

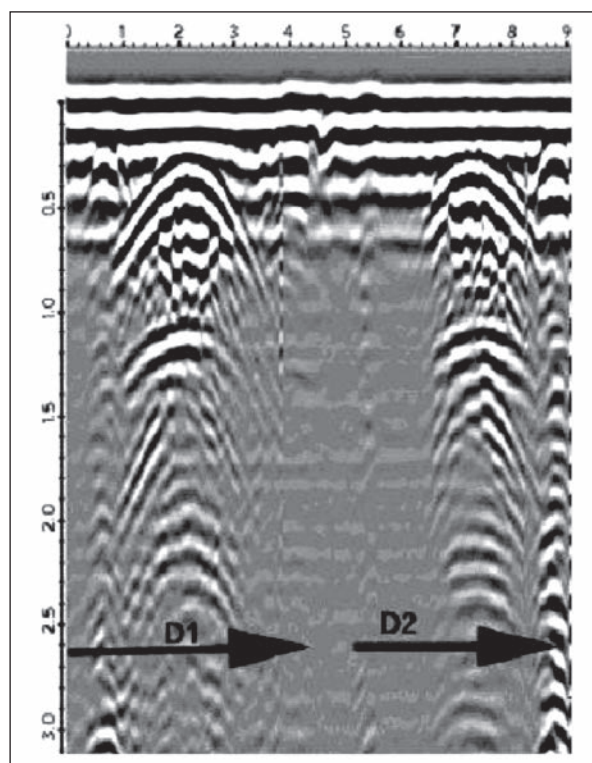

Fig. 2. Typical character of received 2D radarograms by means of the GPR technique - in the area of the anomaly Nr. 3 from Fig. 1 (units of axes are metres).

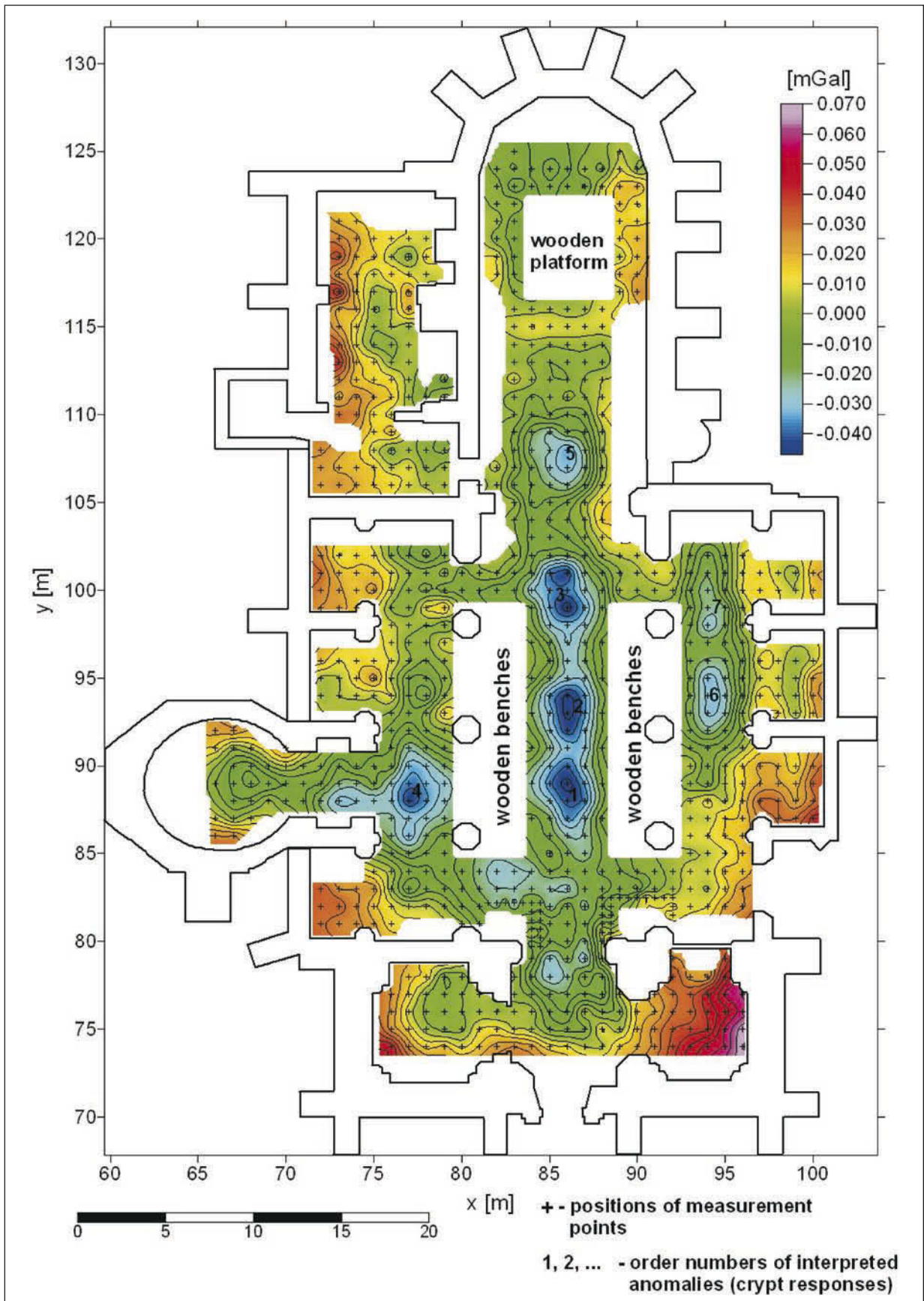

Fig. 1. Final version of the Bouguer anomaly (for the correction density $1.80 \text{ g}\cdot\text{cm}^{-3}$), with removed gravity effect of the walls and a linear regional trend.

the church. This structure was not detected by means of the microgravity survey because of the covering effect of the near wall - this effect was modelled, but as it can be seen in the results presented, not with 100% efficiency. On the other hand, the anomaly Nr. 4 (Fig. 1) was relatively hardly recognized by means of the GPR measurements, because of a higher content of clayey soils covering the crypt structure.

Results

Combining the two geophysical methods presented, a very high efficiency was achieved and their supplementary information could be utilized in problematic situations. All seven anomalies (plus one additional, recognized only by means of GPR survey) were additionally verified by means of a simple camera system, which was entered in a simple borehole, made by means of a hand-held drill system. The majority of the recovered crypts were empty, two of them had coffins inside. But the most important information obtained was the detailed description of the building structure of the crypts and their relation to the structure of the basement of the church - valuable facts for architects and historians.

REFERENCES

*Pašteka/Mikuška/Hajach/
Pašiaková 2006*

Terray 2006

R. Pašteka/J. Mikuška/M. Hajach/M. Pašiaková: Results of the geophysical (microgravimetric) research of the interior of St. Nicholas church in Trnava. Final report, MS Faculty of Sciences, Comenius University, Bratislava 2006, 13.
M. Terray: Report of the GPR measurements in the St. Nicholas church in Trnava. Final report, MS Terra Ltd., Košice 2006, 14.

Roman Pašteka
Miroslav Hajach
Mariana Pašiaková
Department of Applied and Environmental Geophysics
Faculty of Sciences, Comenius University
SK-842 15 Bratislava, Slovak Republic
pasteka@fns.uniba.sk
hajach@fns.uniba.sk

Miroslav Terray
Mudroňova 29
SK-040 03 Košice, Slovak Republic
terray@terray.sk

APPLICATION OF GPR INVESTIGATIONS IN THE URBAN AREA OF FORUM (ROMA, ITALY)

Salvatore Piro

Key words: GPR, archaeological excavations, Palatino Hill, Colosseum Valley, Rome.

To enhance the knowledge of the subsoil between the s. Bonaventura site (Palatino Hill), the N-E foot of Palatino Hill and Colosseum Valley (Rome), and to locate the unknown buried structures below the actual studied levels, a scientific collaboration between La Sapienza University of Roma (Department of Archaeology) and the Institute of Technologies Applied to Cultural Heritage (ITABC-C.N.R.) has been developed, starting in 2001 and still being in progress.

This area is characterised by a sequence of complex buildings, related to the Roman period between the Late Republican and Severo's age. Archaeological excavations made during 2004-2006 located a portion of the foundation of a portico, which bordered the way through the Colosseum Valley and Roman Forum, a portion of a sewerage system with S-N direction and a foundation with E shape, which closed the Elagabalos's Thermae.

In this complex site, a new series of GPR surveys employing different frequencies was carried out (Fig. 1), taking into account results of previous surveys (*Piro/Panella 2005; Cardarelli/Piro 2005*).

Two different GPR Sir Systems (GSSI), equipped with a 500 MHz bistatic antenna with constant offset and a 70 MHz monostatic antenna were employed for the measurements. Some signal processing and representation techniques were used for data elaboration and interpretation.

GPR surveys were performed, employing both a SIR 10A⁺ (GSSI) and a SIR 3000 (GSSI), equipped with a 500 MHz bistatic antenna with constant offset, to survey the selected area on the foot of Palatino Hill (Area A) and on S. Bonaventura site (Area C), Fig. 1. GPR surveys were also performed, employing a SIR 10A⁺ (GSSI), equipped with a 500 MHz bistatic antenna with constant offset and a 70 MHz monostatic antenna, to survey a selected area in the Colosseum valley (Area B).

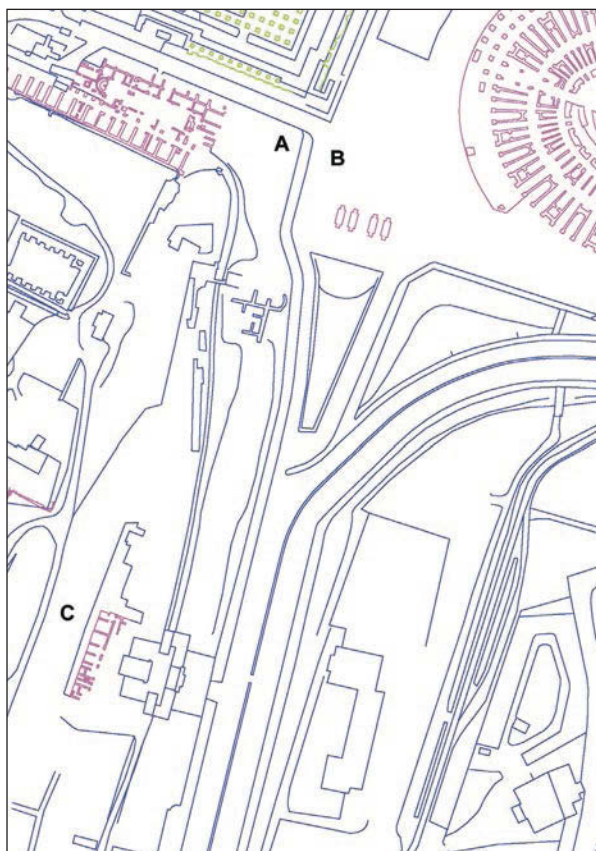

Fig. 1. Roma, Palatino Hill. Location of the investigated area: A, B and C.

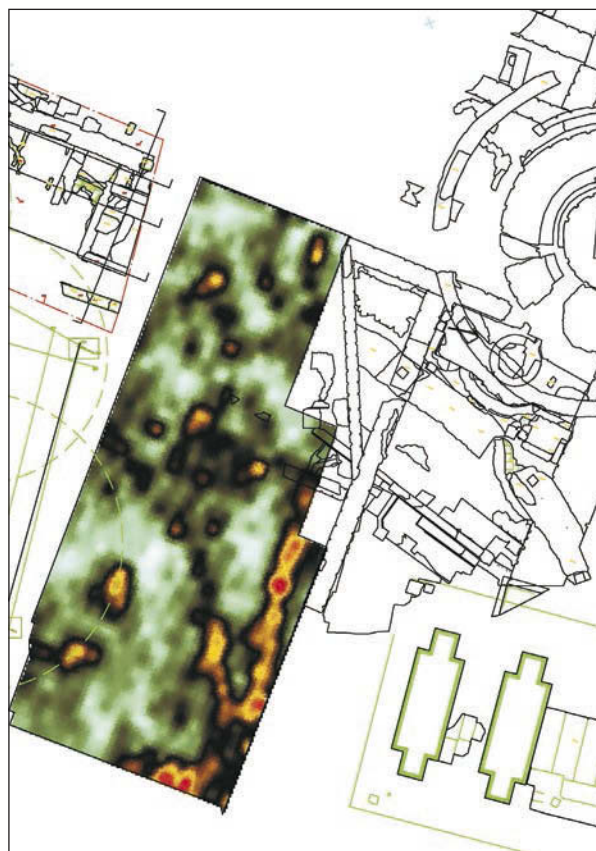

Fig. 2. Roma - Colosseum Valley. GPR time-slice related to the estimated depth of 2.40 m.

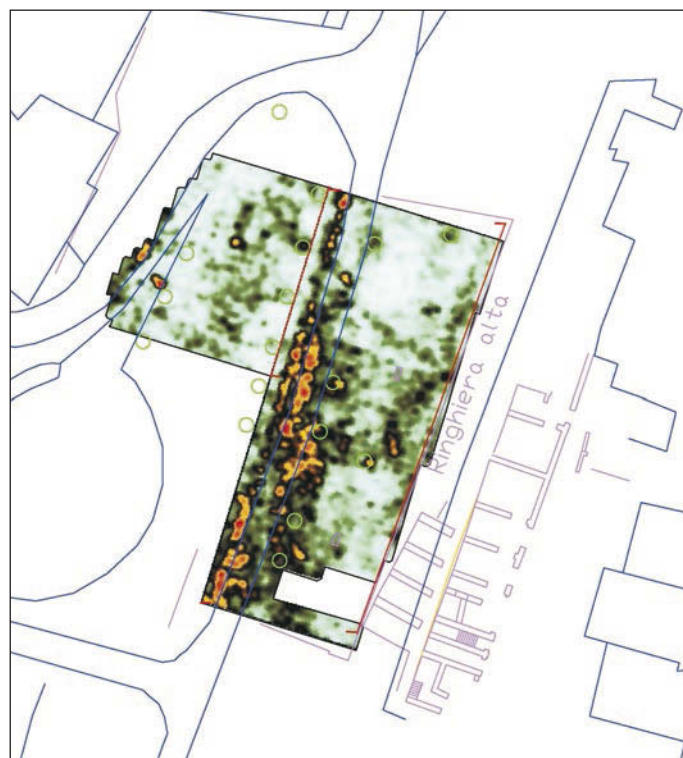

Fig. 3. Roma - Palatino (S. Bonaventura). GPR time slice related to the estimated depth of 1.0 m.

The horizontal spacing between parallel profiles at the site was 0.5 m, employing the two indicated antennas. Radar reflections along the transects were recorded continuously, with different length, across the ground at 80 scan s⁻¹; horizontal stacking was set to 4 scans. Along each profile markers were spaced every 1 m to provide spatial reference. All radar reflections within the 95 ns, 105 ns and 113 ns (two-way-travel time) time window were recorded digitally in the field as 8 bit data and 512 samples per radar scans.

With the aim of obtaining a planimetric vision of all possible anomalous bodies the time-slice representation technique was applied using all field profiles (*Goodman et al. 1995; Piro et al. 2003, 2005*). Time-slices are calculated by creating 2-D horizontal contour maps of the averaged absolute value of the wave amplitude from a specified time value across parallel profiles. Time slice data sets were generated by spatially averaging the squared wave amplitudes of radar reflections in the horizontal as well as the vertical. The data were gridded using a Kriging algorithm that included a search of all data within a 1.0 m radius of the desired point to be interpolated on the grid. Filter was used to remove the background reflections.

In Fig. 2 the time-slice (22-27 ns twt) for the investigated block of the area **B**, between N-E foot of Palatino Hill and Colosseum Valley, is shown. In Fig. 3 the time-slice (estimated depth 1.0 m) for the investigated block of the area **C**, S. Bonaventura site, is shown. On this map the individuated anomalies are better visible.

Recent archaeological excavations made by University La Sapienza of Rome, in the last three years in the area **A** and near the area **B**, have confirmed the structures individuated by geophysical methods. This project is still in progress and new surveys, employing integrated geophysical methods, are planned for the next year.

REFERENCES

- Cardarelli/Piro 2005* E. Cardarelli/S. Piro: Integrated geophysical survey in the urban area. The case of N-E foot of Palatino Hill (Rome, Italy). 6th International Conference on Archaeological Prospection, Rome 2005, 210-214.
- Goodman/Nishimura/Rogers 1995* D. Goodman/Y. Nishimura/J. D. Rogers: GPR time-slice in archaeological prospection. *Archaeological Prospection* 2, 1995, 85-89.
- Piro/Goodman/Nishimura 2003* S. Piro/D. Goodman/Y. Nishimura: The study and characterisation of Emperor Traiano's Villa (Altopiani di Arcinazzo, Roma) using high-resolution integrated geophysical surveys. *Archaeological Prospection* 10, 2003, 1-25.
- Piro/Panella 2005* S. Piro/C. Panella: Geophysical and Archaeological investigations on the N-E foot of Palatino Hill (Roma, Italy). 6th International Conference on Archaeological Prospection, Rome 2005, 253-257.

Salvatore Piro

Institute for Technologies Applied to Cultural Heritage ITABC-CNR
Research Area Roma1 - National Research Council of Italy
P.O. Box 10 - 00016 Monterotondo Scalo, Roma, Italy
Salvatore.piro@itabc.cnr.it

INTEGRATED SURVEYS TO LOCATE CHAMBER TOMBS IN THE SABINE NECROPOLIS (ROME - ITALY)

Salvatore Piro - Roberto Gabrielli - Daniela Peloso

Key words: *cavities, gradiometric survey, 3D laser scanner, Sabine Necropolis*

The location of subsurface archaeological features and the estimation of their dimensions are one of the most important problems in planning archaeological prospection.

This paper presents differential magnetic surveys at an archaeological test site to detect subsurface anomalous bodies and topographical and 3D laser scanner surveys made after archaeological excavation to fix the state of conservation of the studied tombs.

The site is located at the same grounds as the installations of ITABC near Rome and hosts a Sabine Necropolis.

The integrated surveys

Geologically, this area is characterised by a series of lithoid tuffs about 10 m thick, lying on Pleistocene-Quaternary sandy-clay sediments. The resistivity of the tuffs is about 30 Ω·m. The tuffs are capped by a thin layer of soil

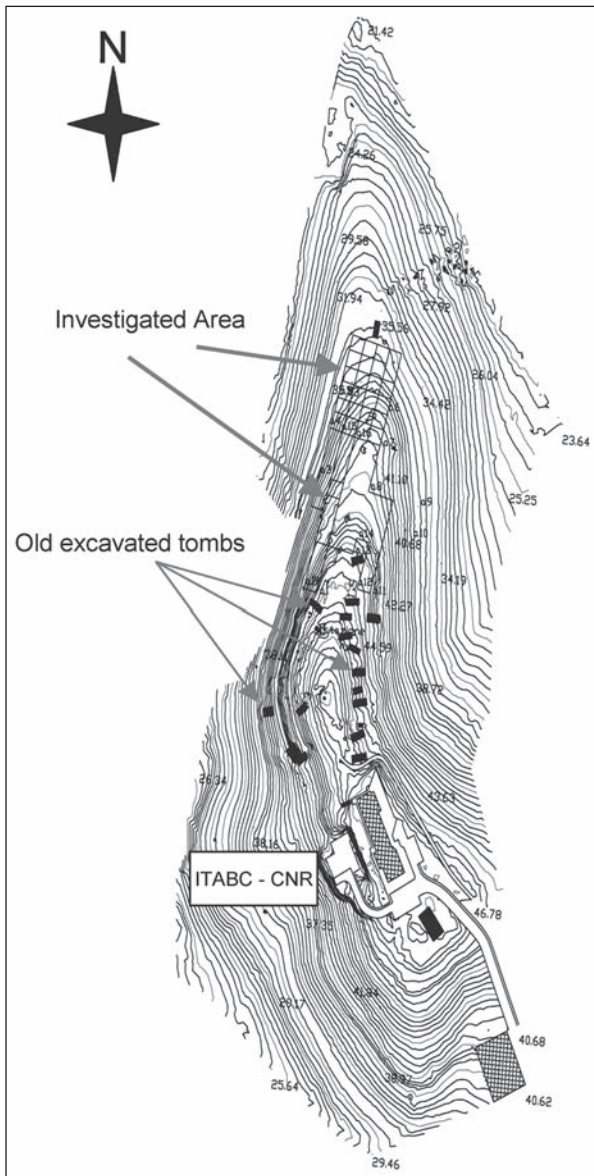

Fig. 1. Map of the Sabine Necropolis at Colle del Forno (Montelibretti, Rome). Arrows indicate the surveyed area and the location of previously excavated tombs.

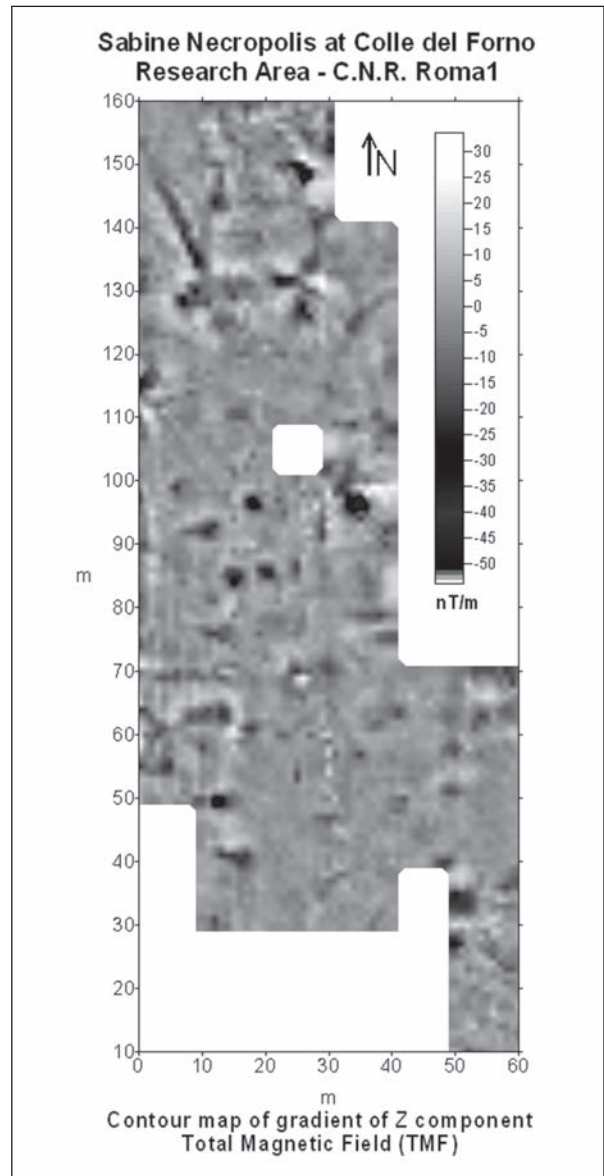

Fig. 2. Fluxgate gradiometer gridded colour contour map of the surveyed area.

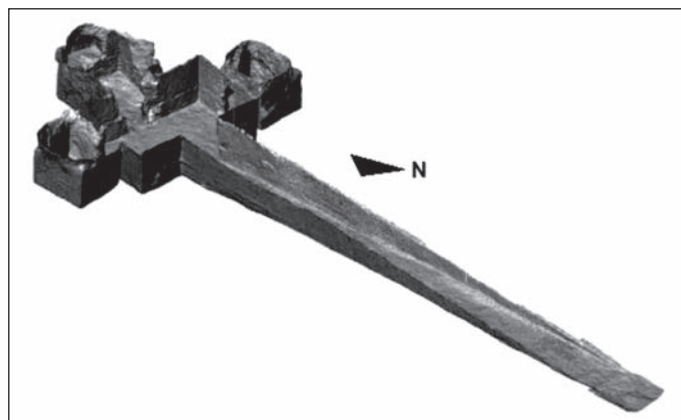

Fig. 3. Digital view of the archaeological structure after a ground-based 3D laser scanner survey.

20-30 cm thick (Piro *et al.* 2001a). From the archaeological point of view, the test area comprises the Sabine Necropolis (700-300 B.C.) at Colle del Forno (Montelibretti, Rome), characterised by chamber tombs with corridor (dromos). Previous excavations showed that the average dimensions of cavities are $2 \times 2 \times 1.5 \text{ m}^3$, while their roofs are about 1 m below the ground surface. The top-soil layer is about 0.3 m (Piro/Santoro 2001b).

Taking into account the surface of the "Colle del Forno" hill, the selected area has been surveyed topographically employing a D-GPS (Differential Global Positioning System) model SR530 Leica, integrated with an Electronic Total Station Trimble (model 5600).

During the DGPS survey, done to reduce the inaccuracy due to the different synchronism between the signal received from the satellite and the signal emitted from the receiver, the distance between the satellite and the receiver was correlated to the phase of the signal, Fig. 1 (Colosi *et al.* 2000; Gabrielli 2001).

For the specific magnetic survey (May 2003), measurements were carried out employing a Geoscan FM 36 fluxgate gradiometer. During the survey the bottom sensor was used at a constant height (0.30 m) from the soil. The $60 \times 150 \text{ m}$ area was subdivided into many 10 m squares due to instrument memory capacity and logistic reasons, wherein we recorded parallel S-N profiles spaced 0.5 m apart each 10 m long. The Magnetic data, after the usual pre-elaboration techniques such as despiking, filtering and rearranging (Brizzolari *et al.* 1992; Piro *et al.* 1998), were represented by scale of contour maps of the residual values of the gradient of the Z component for the 4 assembled squares.

The analysis of this map shows that the area is characterised by many dipolar anomalies in a range of -40 to +35 nT/m. These anomalies are spatially organised as a pseudolinear or circular structures.

The most significant magnetic result is related to the presence of a well defined dipolar anomaly, characterised by a prevalence of the negative component of the dipole (Fig. 2). The very intense negative nucleus can be likely ascribed to a buried structure showing negative susceptibility contrast with respect to the surrounding material. This is particular true in the case of an empty cavity or in the case of the corridor full of sediments with lower susceptibility value respect to that of the tuff layer (volcanic material).

Taking into account the results of previous magnetic surveys and the subsequent archaeological excavations made in the period 1999-2001 (Piro/Santoro 2001b), we can claim that this kind of magnetic anomaly corresponds to the searched tombs (chamber tomb with corridor).

As known, the 3D laser scanner acquisition technique is a methodology based on the acquisition of geometrical data with very high accuracy and speed, and represents a non-invasive technique of investigation. This technique was used after the excavation of the biggest tomb located. For the high-resolution survey of the excavated tomb a Laser Scanner Callidus CP 3200 system (Trimble) was employed. The measurements were collected from 12 viewpoints with a sampling of 0.125° , for the horizontal resolution, and a sampling of 0.25° for a vertical resolution. During the survey, a digital camera was used to collect pictures of the investigated surface of the monument. For the elaboration the 3D-Extractor software was employed, which automatically lines up the pictures made by digital camera together with a polygonal model, making a three-dimensional geometrical reconstruction. The software stores automatically the three-dimensional measurements and reconstructs only one three-dimensional object (in this case the excavated tomb), Fig. 3.

The tomb, located exactly in the position of the geophysical anomalies, was interpreted, by the archaeologists, in the preliminary step as a king tomb of Eretum town. This tomb is characterized by three different rooms with squared dimensions of about $2 \times 2 \text{ m}^2$ and a very long corridor with the length of 27 m, filled with sediments.

Acknowledgements

We would like to thank Paola Santoro (ISCIMA-CNR) for the useful archaeological information; Daniele Verrecchia (ITABC-CNR) for his valuable assistance during the geophysical surveys.

REFERENCES

- Brizzolari/Cardarelli/Feroci/Piro/Versino 1992
E. Brizzolari/E. Cardarelli/M. Feroci/S. Piro/L. Versino: Magnetic survey in the Selinunte Archaeological Park. *Boll. Geof. Teor. Appl.* XXXIV, 1992, 134-135, 157-168.
- Colosi/Gabrielli/Rose 2000
F. Colosi/R. Gabrielli/D. Rose: Integrated use of DGPS and Total Station for the survey of archaeological sites: the case of Colle Breccioso (Borgorose, Rieti). *Proceeding of CAA 2000: Computing Archaeology for Understanding the Past.* BAR International Series, 2000, 9-12.
- Gabrielli 2001
R. Gabrielli: Introduzione all'uso dei GPS in Archeologia. In: *Remote Sensing in Archaeology.* Firenze 2001, 229-254.
- Piro/Samir/Versino 1998
S. Piro/A. Samir/L. Versino: Position and spatial orientation of magnetic bodies from archaeological magnetic surveys. *Annali di Geofisica* 41, 1998, 343-358.
- Piro/Tsourlos/Tsokas 2001
S. Piro/P. Tsourlos/G. N. Tsokas: Cavity detection employing advanced geophysical techniques: a case study. *European Journal of Environmental and Engineering Geophysics* 6, 2001 3-31.

Piro/Santoro 2001

S. Piro/P. Santoro: Analisi del territorio di Colle del Forno (Montelibretti, Roma) e scavo nella necropoli sabina arcaica. *Orizzonti - Rassegna di Archeologia II*, 2001, 197-212.

Salvatore Piro
Roberto Gabrielli
Daniela Peloso

Institute for Technologies Applied to Cultural Heritage ITABC-CNR
Research Area Roma1 - National Research Council of Italy
P.O. Box 10 - 00016 Monterotondo Scalo, Roma, Italy
Salvatore.piro@itabc.cnr.it
roberto.gabrielli@itabc.cnr.it

ELECTROMAGNETIC, GPR AND RESISTIVITY IMAGING MEASUREMENTS FOR STUDYING THE LOESS ARCHAEOLOGICAL SITE OF KARMANOWICE (POLAND)

Artur Poreba

Key words: archaeological investigation, GPR, resistivity imaging, conductivity, loess

The results of electromagnetic, GPR and resistivity imaging surveys carried out at the neolithic archaeological site of Karmanowice situated on Naleczow Plateau (central-east Poland, Lublin province). The site of ca. 10 ha of surface area is located on the loess hill slope. Loess areas, prone to erosion processes and agricultural activities are a great treasury of ancient sites, which unfortunately undergo processes of serious destruction (Kruk *et al.* 1996). During past archeological research of the site, the settlement and burial-ground were found (farm pits, graves, huts, Nogaj-Chachaj 1991).

The investigation presented was performed by three non-invasive geophysical techniques: electromagnetic, ground penetrating radar (GPR) and resistivity imaging method.

First, electromagnetic measurements along the parallel profiles, situated with 1m distance were carried out (Poreba *et al.* 2003). Resistivity imaging and GPR profiles were surveyed along profiles selected of former soil apparent conductivity and archaeological surveys.

GPR system with antenna of 500 MHz frequency was applied, and the measurements were done with a 30 and 60 ns time windows. The resistivity imaging was applied using Schlumberger array with a constant electrode separation of 0,5 m.

The results of GPR and resistivity measurements indicate the sedimentary sequences and specific structures of loess deposits. The border between anthropogenic changed layer and undisturbed loess stratum can be established as well.

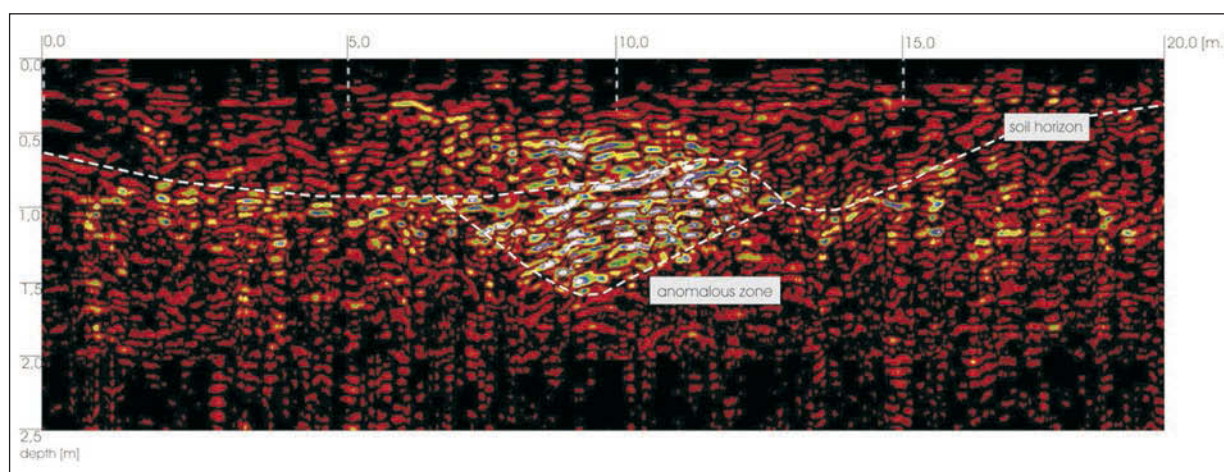

Fig. 1. Selected GPR section profile of the archaeological site in loess. The anomalous zone was assumed to be an ancient tomb.

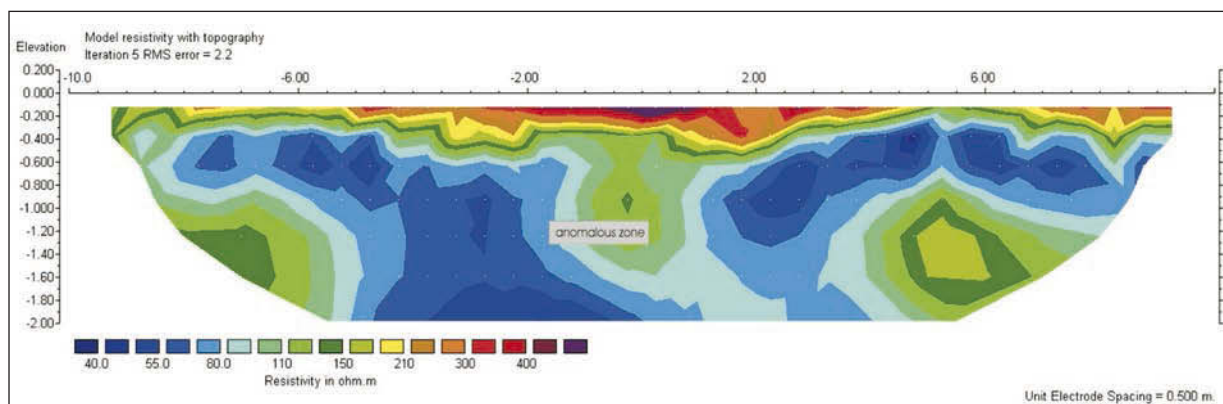

Fig. 2. Map of inversion resistivity section, perpendicular to directions of the selected GPR profile (Fig. 1), and the corresponding location of ancient tomb.

The employment of geophysical techniques for Karmanowice site allowed to outline some anomalies in subsurface soil layers, and to define the geometry and depth of deposition of a few buried archaeological structures (Fig. 1, 2).

The geophysical methods applied in Karmanowice site appeared to be effective in determination of genetic stratification in loess and location of buried archaeological objects. This geophysical data was verified by drilling. Integrated application of geophysical methods and geological probes considerably decreased the ambiguity of data interpretation.

REFERENCES

- Poreba/Żogała/Nogaj-Chachaj* 2003
A. Poreba/B. Żogała/J. Nogaj-Chachaj: The Application of electromagnetic method in archaeology on the example of neolithic settlement in Karmanowice (Poland), Proceedings of the 9th Meeting Environmental and Engineering Geophysics, Prague 2003.
- Nogaj-Chachaj* 1991
J. Nogaj-Chachaj: The stone-packed graves of the Funnel Beaker culture in Karmanowice, site 35. *Antiquity* 65, no. 248, 1991, 628-640,
- Kruk/Alexandrowicz/Milisauskas/Śnieszko* 1996
J. Kruk/S. W. Alexandrowicz/S. Milisauskas/Z. Śnieszko: *Osadnictwo i zmiany środowiska naturalnego wyżyn lessowych*, Kraków 1996.

Artur Poreba
University of Silesia
Faculty of Earth Science
Bedzinska 60 st., 41-200, Sosnowiec, Poland
aporeba@wnoz.us.edu.pl

GEORADAR AND ELECTRICAL TOMOGRAPHY SURVEYS COMPARED TO AN OLD ARCHAEOLOGICAL MAP (NECROPOLIS OF "CASALE DEL FOSSO" - VEIO, ITALY)

Valeria Poscetti

Key words: georadar, electrical tomography, necropolis

In summer 2006, georadar and electrical tomography surveys were performed at the archaeological site of the ancient necropolis at "Casale del Fosso", which is one of the several necropoli of the important Etruscan town *Véio*.

The surveyed area (Fig. 1) was partially excavated at the beginning of the 20th century (1915-16). The archaeological reports dating from that period describe the typology of the tombs and the related material (pottery, iron tools etc.). The archaeological structures consist mainly of fossa graves and some chamber tombs with entrance corridor

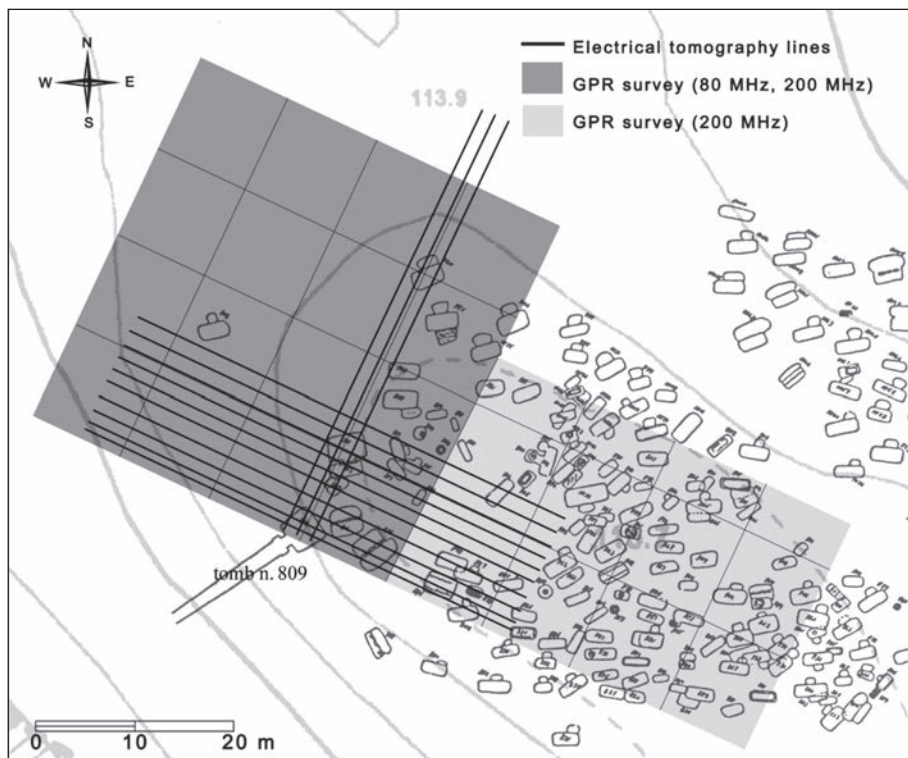

Fig. 1. Topography of the surveyed area (Cartography by Cartesia-Cartografia digitale, S.p.A. www.cartesiaspa.it). Gray zones surveyed with GPR and black lines with electrical tomography. The GPR profiles are acquired NW-SE.

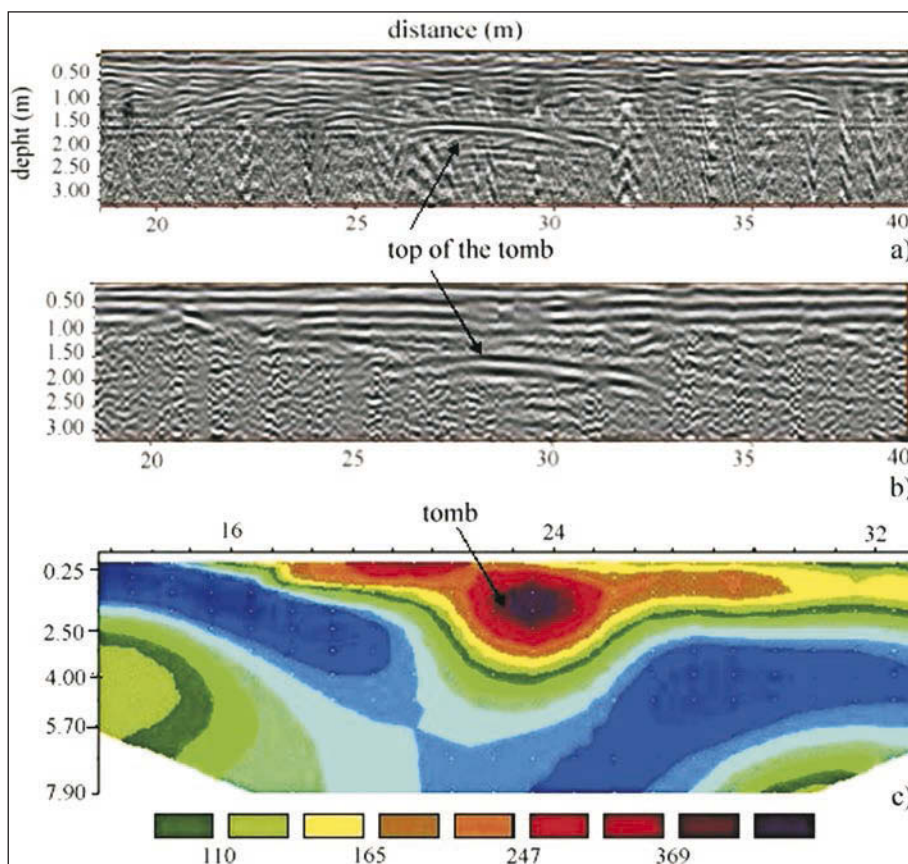

Fig. 2. Partial view of radargrams and tomography profiles on excavated tomb no. 809.

- *dromos* (Buranelli et al. 1997). Nothing of the ancient necropolis is currently visible, except for the dromos chamber tomb no. 809 (Buranelli et al. 1997, Figs. 2 and 51-54) which, until recently, was used as a farmer's cellar.

GPR and resistivity methods were applied at the site in order to find correlations between geophysical anomalies and the tombs on the original map but not visible in the field at present. Moreover, the aim of the geophysical survey was to detect the possible existence of other structures, related to the ancient necropolis, outside and below the area excavated in 1915-16.

Preliminary measurement tests were carried out above and near the tomb no. 809 in order to establish the performance of the geophysical methods at the site. The tomb was also used as a topographic reference for matching the old map with the geophysical data acquired on the field.

Geoarchaeological background

The necropolis is located on a small hill which is geologically characterized by lithoid tuff covered by a thin layer of top soil, of variable thickness from 0.20 to 0.5 m (Cammarano et al. 1997; Piro 2005). Most of the tombs discovered in the early 1900s were made up of medium size (usually "*fossa*") tombs and chamber tombs of about 2-3.5 m in size with entrance corridors (*dromos*) of a few metres. The *fossa* tombs, mainly located on the top of the hill, generally belong to the older phases of the necropolis (8th century B.C.); the *dromos* chamber tombs are more recent (7th and beginning of the 6th century B.C.) and are located along the slopes of the hill. The tomb mentioned above is part of these chamber tombs and is also one of the most important structures found in the necropolis so far. Tombs are excavated in the lithoid tuff, at different depths that do not generally exceed 3-4 metres.

Data acquisition

GPR survey was conducted over two adjacent areas (Fig. 1) using a georadar of IDS Corporation equipped with 80 and 200 MHz antennas. The data were collected in continuous mode along parallel profiles stretching NW-SE. The profiles acquired with 80 MHz antenna were 1 m apart and with the 200 MHz antenna 0.5 m apart. The first area, 40x40 m wide, was surveyed with a time window of 256 ns, a sampling time interval of 0.5 ns and sampling spatial interval of 0.048 m for 80 MHz and a time window of 256 ns, a sampling time interval of 0.5 ns and sampling spatial interval of 0.025 m for 200 MHz. The second area, 40 x 25 m, was investigated with 200 MHz antenna.

Electrical tomography (Fig. 1) was applied in a 40 x 25 m area partially overlaying the GPR surveyed area. Ten lines were acquired in a NW-SE direction, and three lines perpendicular to the previous ones. These three lines have the zero located in correspondence of the chamber tomb no. 809. Lines were spaced 1.5 m apart, each line arranged with 48 electrodes 1 m apart. The data were collected using Wenner, dipole-dipole and Schlumberger arrays.

Processing and Results

The GPR data are processed with setting time zero, band pass filter and traces mix. The band pass filter was 80-400 MHz for 200 MHz antenna and 40-250 MHz for 80 MHz. The profiles were used for a 3D representation (Malađodi et al. 1996; Piro et al. 2003).

The profiles and the time slice related to the first area (Fig. 2, 3) clearly show the anomaly caused by the hypogean chamber of the tomb no. 809. This anomaly, which is located at about 2 m below ground level, corresponds to the top of the burial chamber and is clearly visible on both the 80 MHz and the 200 MHz radargrams (Fig. 2: a, b). The hypogean chamber was clearly detected also by the electrical tomography, which shows a sharp high resistive anomaly whose dimensions roughly correspond to the tomb size (Fig. 2: c). It is interesting to observe that resistivity data give estimation of the chamber height.

Moreover, the GPR and resistivity data show many anomalies located at the depth range of 0.50-2.00 m probably caused by *fossa* tombs of the necropolis. In particular the 200 MHz time slices (Fig. 3) show a clear anomaly pattern that matches the high density of *fossa* tombs excavated in the area (Fig. 1).

In the southern part of the 40x40 m area, the time slices relating to the depth range of 2-3 m show a high amplitude anomaly, about 20 m long and 8 m wide. Considering the topography, the anomaly is flat and its east extremity corresponds roughly to the position of the chamber tomb. The anomaly is better detected with the 80 MHz profiles. This strong reflector partially coincides with the bottom of a high resistive layer, detected by electrical method, located roughly in the first 2-3 meters below ground level.

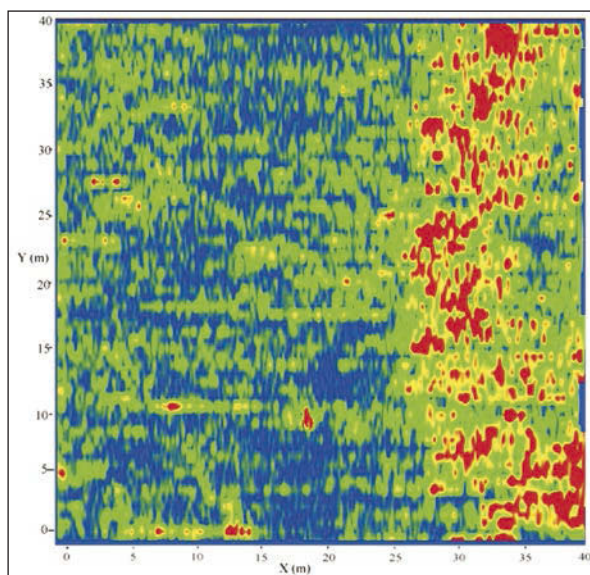

Fig. 3. GPR survey in the 40x40 m area: 200 MHz time slice related to a depth of 1.20 m

Conclusion

The integrated geophysical prospection at "Casale del Fosso" has shown the effectiveness of GPR and geoelectrical methods in detecting the archaeological structures of the Necropolis. Comparisons of the geophysical data with the old map of the archaeological site prove that an exhaustive geophysical survey could be useful for a complete archaeological mapping of the site. Specifically, the good results obtained in detecting the chamber tomb lead to the possible finding of other structures of the same kind.

REFERENCES

- Buranelli/Drago/Paolini 1997* F. Buranelli/L. Drago/L. Paolini: La necropoli di Casale del Fosso. Le necropoli arcaiche di Veio, Giornata di studio in memoria di Massimo Pallottino (a cura di Gilda Bartoloni), Roma 1997, 63-83.
- Cammarano/Mauriello/Piro 1997* F. Cammarano/P. Mauriello/S. Piro: High-Resolution Geophysical Prospecting with Integrated Methods. The Ancient Acropolis of Veio (Rome, Italy). *Archaeological Prospection* 4, 1997, 157-163.
- Malagodi/Orlando/Piro/Rosso 1996* S. Malagodi/L. Orlando/S. Piro/F. Rosso: Location of Archaeological Structures using GPR Method: Three-dimensional Data Acquisition and Radar Signal Processing. *Archaeological Prospection* 3, 1996, 13-23.
- Piro 2005* S. Piro: Integrazione di metodi geofisici ad alta risoluzione per l'indagine nei siti archeologici: il caso di Piazza d'Armi - Veio, in *Dinamiche di sviluppo delle città nell'Etruria meridionale. Veio, Caere, Tarquinia, Vulci. Atti del XXIII Convegno di Studi Etruschi ed Italici*, Roma-Pisa 2005, 125-134.
- Piro/Goodman/Nishimura 2003* S. Piro/D. Goodman/Y. Nishimura: The study and characterization of Emperor Traiano's villa (Altopiani di Arcinazzo, Roma) using high-resolution integrated geophysical surveys. *Archaeological Prospection* 10, 2003, 1-25.

Valeria Poscetti
"La Sapienza" University
via Proba Petronia 31, 00136 Roma, Italy
valpos@tiscali.it
valeria.poscetti@alice.it

GEOPHYSICS AND EXCAVATION - LAYERS OF ARCHAEOLOGICAL FEEDBACK

Martin Posselt

Key words: *archaeological feedback, magnetometry, radar, landscape archaeology, Neolithic, Roman, Near East*

Still often called an auxiliary method, geophysics with its unique properties as a non-destructive, fast and large-scale working survey technique is used throughout archaeology in many different ways. Its use ranges from a method which is reduced to tell that in a certain spot of a site there might be "something" underneath for excavation up to delivering the main arguments for defining the size, character and dating of features and sites. There are different ways and there might be many more ways of using geophysical methods in archaeology. The knowledge about the potential of geophysics for archaeological research which is derived from the discussion of geophysicists and archaeologists enables to integrate geophysics into archaeological research and research strategies in the proper way. The paper at hand aims to show the difference how geophysics contributes to archaeological research. It is pictured by three case studies, which show different ways of integration into a project depending on the archaeological object and aim of research.

At a roman site at Kelsterbach (Germany) by order of the local historical association (Volksbildungswerk Kelsterbach e.V.) geophysics surveyed a roman site completely and detected the main features which allowed a revised interpretation of the site. Initially the site was estimated as a simple small roman villa rustica. But results of a combined Magnetometer, resistivity and radar survey indicated a picture of the site differing from the usual ground plan of a typical roman villa rustica. The succeeding excavation (University of Frankfurt/Main) of a central building, which comprised a well with a stone wall detected by radar, lead to the interpretation of the site as a place of intense religious activity.

During a long term research project at Tell Chuera (Syria), a city of the third millennium BC the results of a large scale magnetometer-survey which started in 1997 changed the objectives of the archaeologists through the years. While in the beginning the interest of the archaeologists was focused on the interpretation of large stone buildings scattered all over the site the magnetometer survey gradually drew a growing map of the site and its near environs showing a plan of the street system and quarters of different function (dwelling, religious/worship activity, storage, crafts etc.). Furthermore a system of channels inside and outside the outer city walls and more settlements in the near environs of the city lead to new ideas about the meaning and function of the city within the surrounding landscape. Thus research objectives at Tell Chuera were guided from separate spots within the city to the origin of the particular street system and the city just as one of many elements of the ancient cultural landscape.

Since 2001 the project VBI ("Vorgeschichtliche Siedlungsgeschichte in der Idsteiner Senke") researches the early neolithic settlement system in a small landscape in the environs of the city of Idstein (Germany). It is a joint project by the Cultural Heritage Department of Hesse (Wiesbaden) and the University of Frankfurt/Main. The project aims to research the processes of settlement activity by the first farmers, who used the landscape and its resources. Field walking and magnetometry were the major field techniques to survey known sites and to detect new sites as well as to collect data about size and duration of the settlements throughout an area of about 15 km². Reasonably, excavation merely would have been able to contribute few information regarding the dimension of a landscape. Thus the concept of the project refrained from excavation generally. Magnetometry was planned to identify early neolithic houses non-destructively and to define the limits of each settlement allowing to gain data about the number of houses and inhabitants within each settlement during the phases of the early Neolithic period. Finally a picture was created how the first farmers took hold of the landscape, how the settlement system was increasing and decaying over a period of about 500 years in the second half of the 6th millennium BC.

REFERENCES

- Heising 2007* A. Heising: Geophysikalische Daten und Grabungsbefunde im Vergleich. Ein römisches Gebäude bei Kelsterbach, Landkreis Groß-Gerau, Hessen. In: M. Posselt/B. Zickgraf/C. Dobiak (eds.), Geophysik und Ausgrabung. Einsatz und Auswertung zerstörungsfreier Prospektion in der Archäologie. Rhaden/Westf. 2007, 83-98.
- Meyer 2007* J.-W. Meyer: Veränderung der Grabungsstrategie in Tell Chuera (Syrien) aufgrund der Ergebnisse der geomagnetischen Prospektion. In: M. Posselt/B. Zickgraf/C. Dobiak (eds.), Geophysik und Ausgrabung. Einsatz und Auswertung zerstörungsfreier Prospektion in der Archäologie. Rhaden/Westf. 2007, 223-236.
- Nauk/Posselt/Schade-Lindig/Schade 2006* H. Nauk/M. Posselt/S. Schade-Lindig/Ch. Schade: Bandkeramik, Flurbegabung, Geophysik. Die älteste Kulturlandschaft im „Goldenen Grund“ in der Idsteiner Senke. Berichte der Kommission für Archäologische Landesforschung in Hessen 8, (2004/2005), 2006, 91-102.

Martin Posselt
Posselt & Zickgraf Prospektionen GbR
Fürthweg 9
D-64367 Mühlthal, Germany
Posselt@pzp.de

VISUALISING THE IBERO-ROMAN SITE OF PUIG-CIUTAT (CATALONIA, SPAIN) FROM MAGNETIC VARIATION MAPS AND GPR TIME-SLICES

Roger Sala - Maria Lafuente

Key words: fluxgate gradiometer, GPR, time-slicing, Iberian-Roman, Catalonia

The prospection by means of Fluxgate Gradiometer over the buried site of *Puig-Ciutat* (Catalonia, Spain), which has never been excavated and was only known by the subsistence of the place name, the medieval written sources and the presence of abundant Iberian-Roman pottery sherds on the surface, provided us with a magnetic variation map that revealed the existence of a possible urban net beneath the present cultivation field.

A square building was detected in the centre of the field and as a way to gain more details of the feature we surveyed it again by means of GPR with a 400 MHz antenna. The resulting data were processed and visualised using *GPR-Slice* software and this provided us with new information on its shape and internal distribution at different stages, and its depth of burial.

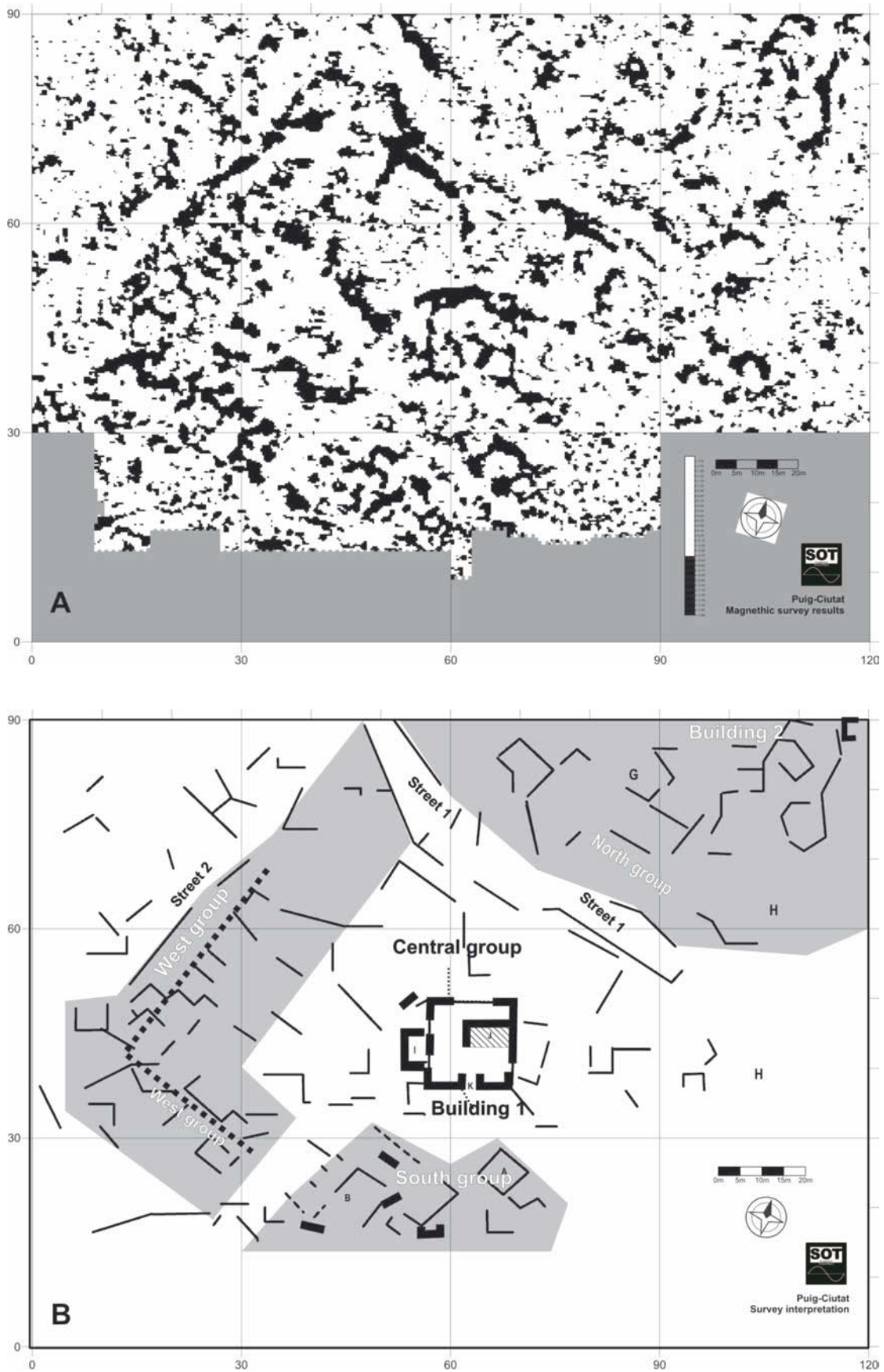

Fig. 1. A - magnetic map (+/- 1.6 nT); B - interpretation of magnetic anomalies.

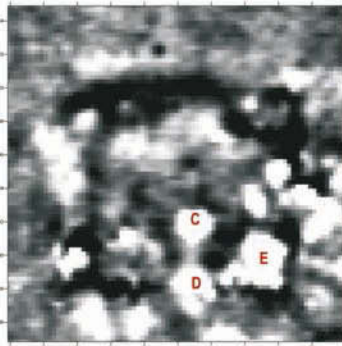

Figure 2A. Building 1
Detail of magnetic survey

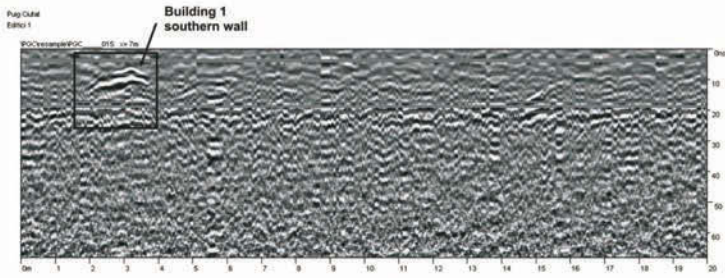

Figure 2B. Background filtered radagram.

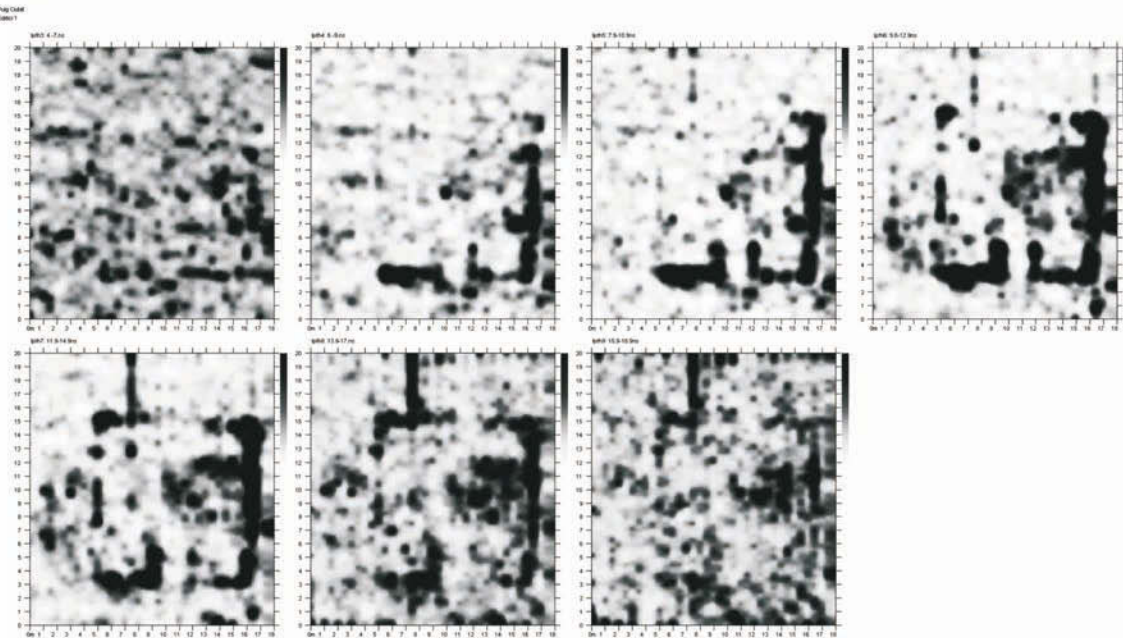

Figure 2C. Slices 3 to 9 from Building 1 GPR survey. View of 4-19ns in 3ns overlapping steps.

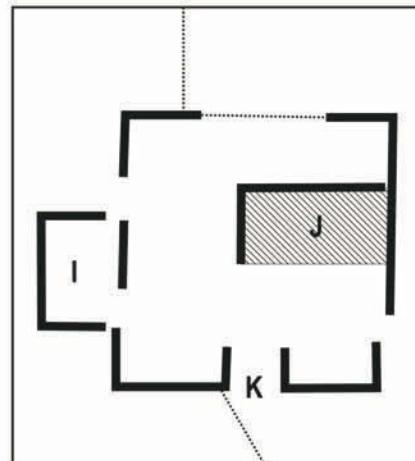
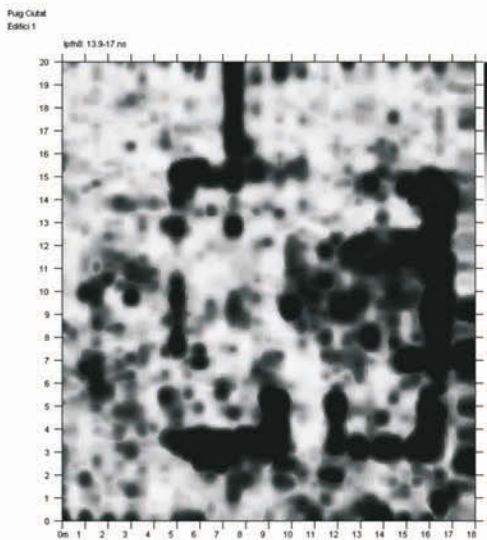

Figure 2D. Overlay of slices 4-8 (6-17ns) and interpretation of detected features.

Fig. 2. GPR slices, radagram and interpretation.

Geographical and historical background of the site

From a historical point of view, the written sources and the material remains over the site suggest that it belongs to the period between the hegemony of the Iberian culture and the early Romanisation, and that it could be one of the several Iberian urban settlements, in this case, one belonging to the tribe that settled in the Lluçanès area.

The site is located on an elevated peninsula generated by a meander of the river Gavarresa. It is thought that the settlement extends under the field on top of the hill as well as under the woodland areas surrounding it, and that the total extension of the site may have been of 4 Ha (400x160 m). The orography of the area makes Puig-Ciutat a good place to settle, an optimum strategic point, which enables to control all the communication net on the NE of the Lluçanès area, and an easy place to defence (Fig. 1B).

Geophysical prospections carried over the site

A. Data acquisition: Geomagnetism and GPR

Two geophysical techniques were used to locate and define the remains in Puig-Ciutat: geomagnetism and GPR.

As for the magnetometry, a Fluxgate Gradiometer (FM256 Geoscan Reserch) was used as a first stage to survey the whole field (120x90 m) following a measuring density of 50x25 cm on a 30x30 m grid net.

As a second stage, a grid (18x20 m) over the previously detected building was surveyed by means of GPR (GSSI SIR-3000) with a 400 MHz antenna and surveying wheel to obtain information on the depth of burial of the feature and a more detailed description of its shape (Fig. 3). A 70 ns time window was used, and the measurement density was 40 sc/m in 512 samples over a grid where the separation between traverses was 50 cm and the collecting mode zig-zag.

B. Data processing

Magnetic data were processed with *Geoplot v. 3* (Geoscan 2003) using zero-mean corrections on traverses and grids, interpolation to obtain a regular data mesh (25x25 cm) and low pass filtering. GPR data were processed with *GPR-Slice v.5* background removal filter (Goodman 2004) to eliminate the high frequency noise and obtain clearest view in the slices (Fig. 3B).

C. Data visualising

As for the magnetic prospection, the resulting plot showed, on one hand, the presence of low contrast magnetic anomalies in most parts of the explored area (± 2 nT), probably due to the use of local materials in buildings. And on the other hand, few high contrast magnetic dipoles in the W and S areas (Fig. 2A).

In order to obtain a clearer view of the anomalies, a black and white scale at ± 1.6 nT was used to show only the anomalies over -0.4 nT (Fig. 2A). A sketch of the identified features was drawn to facilitate the understanding of the magnetic plot.

As for the GPR data, the *time-slicing* visualising technique (Goodman 2004) was used to generate a 3D block of data

obtained by the interpolation of radagrams. To generate the slices, thickness of several slices was tested from 3 ns to 6 ns to obtain as much coherent images as possible of the building. Fig. 3C shows a set of 7 overlapping slices of 3 ns, from 4 to 19 ns (0.16-0.76 m at $v = 0.08$ m/ns). Finally, an overlay of these slices (Fig. 3D) and a volume render were generated too.

D. Data interpretation

The magnetic variations plot suggests the existence of an urban network, which is composed by a big square building (12.5x12.5 m) located in the centre of the surveyed field plus the remains of other big buildings, two possible streets, two sets of smaller buildings, combustion areas and possible silos around it¹.

As for the GPR prospection, taking into account the results of the wave velocity test (0.08 m/ns), it was estimated that the remains begin to appear at 35-40 cm below the surface and continue up to a maximum depth of 120 cm. The overlapping of 4 to 8th slices (Fig. 3D) revealed new remains (I) attached to the W side of the already detected one, and a possible room (J) was detected, and the shape of the S entrance -a corridor- was defined (K)².

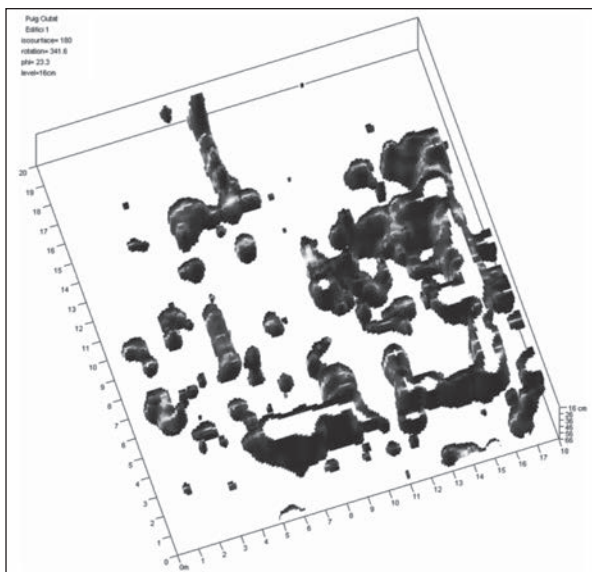

Fig. 3. Volume render of GPR data.

¹ Our interpretation is based on examples from other sites prospected by means of fluxgate gradiometer: CREW, 2002; HOUNSLOW & CHROSTON, 2002; MARMET, 1999; Proceedings, 2005.

² Our interpretation is based on examples from other sites prospected by means of GPR: LINFORD, 2004; LINFORD & LINFORD, 2004; NISHIMURA & GOODMAN, 2000; Proceedings, 2005.

Conclusions

Imaging and presenting information is the last but not the least part of the prospection. In fact, it is the final result of a meticulous work that curators and archaeologists may have not seen. In commercial geophysics it is very important to find a way how to communicate results to our customers, so that they can visualise what there is beneath the soil of the site they take care of, and plan how to record and protect the new heritage.

The survey by means of a combination of Fluxgate Gradiometer and GPR over Puig-Ciutat provided us with a high volume of information, in both an extended view and in a detail view, which remains the only source of description of the shape and contents of the site.

The obtention of a magnetic variation map at first instance was useful for recording a first schematic idea of the extension of the site, locating the main archaeologically affected areas, determining the type of features it contains and defining the shape and size of the most consistent architectural remains.

The use of the *time-slicing* technique to visualise GPR data collected over the building appeared to be the best aid to imaging this buried site, being able to define the inner distribution of the square feature, which was interpreted as a building, and to make evident its evolution with depth. The identification of the building feature in a traditional radargram analysis would have been much more difficult than in a *time-slice* analysis.

REFERENCES

- Geoscan Research 2003* Geoscan Research: Geoplot. Instruction Manual Version 3, Geoscan Research 2003.
- Goodman 2004* D. Goodman: GPR-SLICE. Ground Penetrating Radar Imaging Software. User's Manual. California 2004.
- Linford 2004* N. Linford: From Hypocaust to Hyperbola: Ground-penetrating Radar Surveys over mainly Roman Remains in the UK. *Archaeological Prospection* 11, 2004, 237-246.
- Linford /Linford 2004* N. Linford/P. Linford: Ground Penetrating Radar Survey over a Roman Building at Groundwll Ridge, Blundson St Andrew, Swindon, UK. *Archaeological Prospection* 11, 2004, 44-55.
- Nishimura /Goodman 2000* Y. Nishimura/D. Goodman: Ground-penetrating Radar Survey at Wroxeter. *Archaeological Prospection* 7, 2000, 101-105.

Roger Sala
Maria Lafuente
SOT Archaeological Prospection
Av. Emetrio Escudero 76B
08198 Sant Cugat del Vallès, Barcelona, Spain
info@sotprospections.com
roger_sala_bar@yahoo.es
prospeccions@yahoo.es

GEOPHYSICAL PROSPECTION FOR ARCHAEOLOGICAL INVESTIGATIONS IN SOUTH ASIA

Armin Schmidt - Robin Coningham

Key words: South Asia, archaeology, magnetometer, earth resistance

Archaeological geophysics is successful where archaeological and geophysical investigations are combined to resolve archaeological questions. Simply listing all geophysical anomalies of a survey does not lead to the understanding of a site; data have to be interpreted archaeologically. And this in turn requires a thorough understanding of the geophysical signatures associated with archaeological features in different geological and environmental settings. This paper demonstrates how such integrated investigations have led to new insights in South Asian archaeology.

Geophysical prospection for archaeology is well established in many regions of the world and the conditions under which such surveys can reveal buried archaeological features are mostly understood. However, South Asia

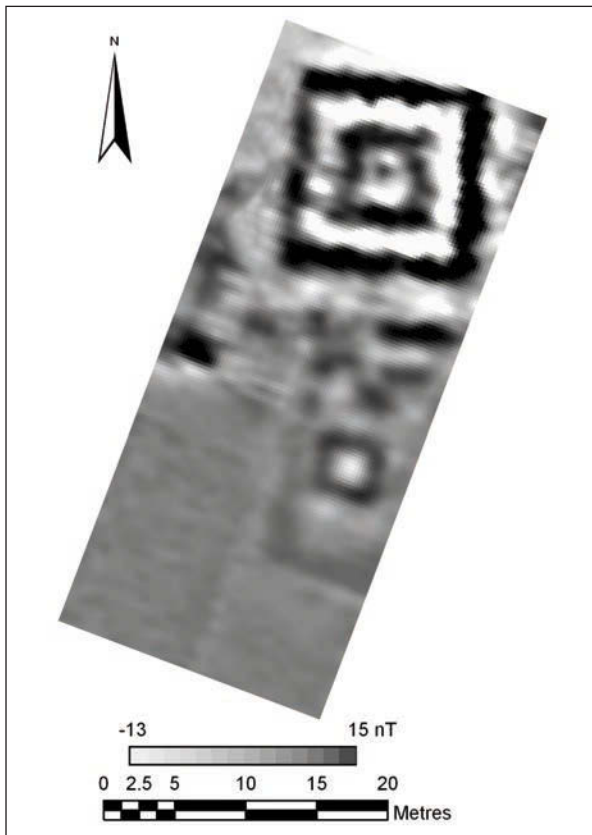

Fig. 1. Ramagrama, Nepal. Magnetometer survey showing brick foundation of vihara structure.

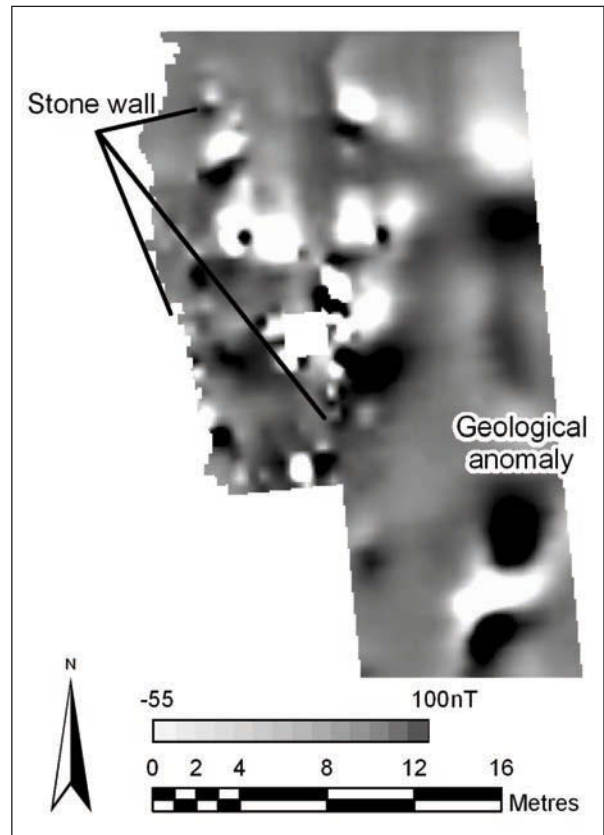

Fig. 2. Marathamaduwa, near Anuradhapura, Sri Lanka (site C112). Magnetometer survey showing small bipolar anomalies of individual stones, demonstrating the anthropogenic origin of wall structures.

has seen only few projects of archaeological prospection and the relationship between buried archaeological remains and measured geophysical anomalies has not been thoroughly explored. In 1997, the authors have started a project to evaluate the use of archaeological geophysical techniques throughout South Asia and have since then undertaken geophysical site studies (using FM36 and RM15) in Bangladesh, Nepal, Pakistan and Sri Lanka. A synopsis of the findings is reported in this paper.

Brick foundations: brick structures can be the best or the worst target for magnetometer surveys, depending on the surrounding matrix. Where the bricks of an abandoned structure were removed, for example for reuse in domestic buildings, the remaining brick foundations can show a very clear magnetic contrast against the less magnetic sedimentary fill. At Ramagrama, Nepal, buildings with cellular structures were detected around a prominent mound (Fig. 1) and their shape and arrangement allowed to interpret them as small Buddhist monasteries (viharas). The „mound“ is considered to be the last unopened relic stupa of the Lord Buddha and the grouping of viharas around it demonstrates that it was already held in high religious regard in antiquity. On other sites, where brick buildings were instead demolished and the resulting rubble spread out, it is very difficult to detect the brick foundation's aligned remanent magnetization within the randomised magnetic site matrix.

Igneous geology: stones from igneous geological sources can produce distinct magnetic bipolar anomalies. If such stones were used as building material, magnetometer surveys can sometimes differentiate the remains of such buildings from geological background. At Marathamaduwa, near Anuradhapura, Sri Lanka, stones of walls on top of a large rock outcrop are clearly visible as individual bipolar magnetic anomalies against much broader geological signals (Fig. 2). However, in some instances the anomalies of igneous geological features, even at several metres depth, can be overwhelmingly strong so that small and weak anthropogenic anomalies cannot be resolved.

Soil moisture: on most investigated sites magnetic survey data proved to be more informative than earth resistance measurements, often due to very dry soil conditions. However, at Tilaurakot, Nepal, earth resistance data clearly revealed the layout of shallow foundations, reminiscent of the „palace complex“ excavated in a different area of the site (Fig. 3). Where buried archaeological features produce anomalies in magnetometer as well as earth resistance data, the latter are often preferable since they usually have more clearly delineated shapes, improving the accuracy of archaeological interpretation.

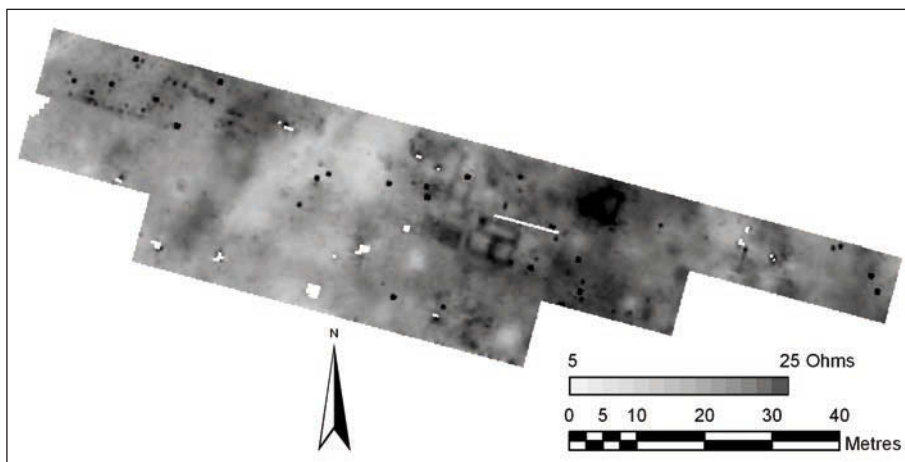

Fig. 3. Tilaarakot, Taulihawa, Nepal. Earth resistance survey east of the western gate, clearly showing structural remains.

Site conditions were not always conducive to geophysical surveys (e.g. dry soil, high vegetation, agricultural crops) and compromises in survey layout had to be made. However, it was demonstrated that the combination of results from confined survey areas into a data patchwork, using GIS, provided opportunities for meaningful site assessment. The importance of reasonably high spatial resolution (e.g. 0.5x0.5 m for earth resistance surveys) has to be stressed, especially on sites with relatively high data variability, for example due to rubble spreads. The project demonstrated similarities of site conditions across South Asia (e.g. remains of brick buildings). Based on these findings guidance for geophysical prospection on the subcontinent can now be compiled.

Armin Schmidt
University of Bradford
Archaeological Sciences, Division of AGES
Bradford BD7 1DP, United Kingdom
A.Schmidt@Bradford.ac.uk

Robin Coningham
Department of Archaeology
Durham University, R.A.E.
South Road, Durham, DH1 3LE, United Kingdom
Coningham@Durham.ac.uk

LARGE-SCALE, FAST AND SENSITIVE GEOMAGNETIC ARCHAEOLOGY USING A SQUID-BASED MEASUREMENT SYSTEM

Volkmar Schultze - Sven Linzen - Tim Schüler - Ronny Stolz - Andreas Chwala
- Marco Schulz - Hans-Georg Meyer

Key words: geomagnetic prospection, archaeometry, SQUID, Neolithic ring ditch

A new, unique system for geomagnetic archaeometry is presented. It uses extremely sensitive Superconducting Quantum Interference Devices (SQUIDs) as magnetic field sensors.

Our SQUIDs are laid out as integrated SQUID gradiometers. Therefore, they measure intrinsically the magnetic field gradient and are - in the ideal status - not sensitive to homogeneous magnetic fields. This has two advantages. First, this enables the SQUIDs to be moved freely in the Earth's magnetic field. Because SQUIDs are vectorial sensors, as magnetometers they would sense any movement with respect to the Earth's magnetic field vector, which would completely overwhelm the small signals from the ancient structures. The second advantage of the integrated gradiometers with base lengths (this is distance between the two sensitive areas) of only 4 cm is the stronger sensitivity to near-surface patterns compared to a magnetometer. This helps to resolve weak signals of archaeological patterns from coexistent deeper geological formations. Nevertheless, due to the heir ultimate magnetic field resolution of few femto Teslas, also deep sources can be resolved with good resolution with the SQUIDs.

One major challenge of the system development was to make the used SQUID gradiometers really that insensitive to the homogeneous Earth's field during movement. With three additional, less sensitive orthogonal SQUID

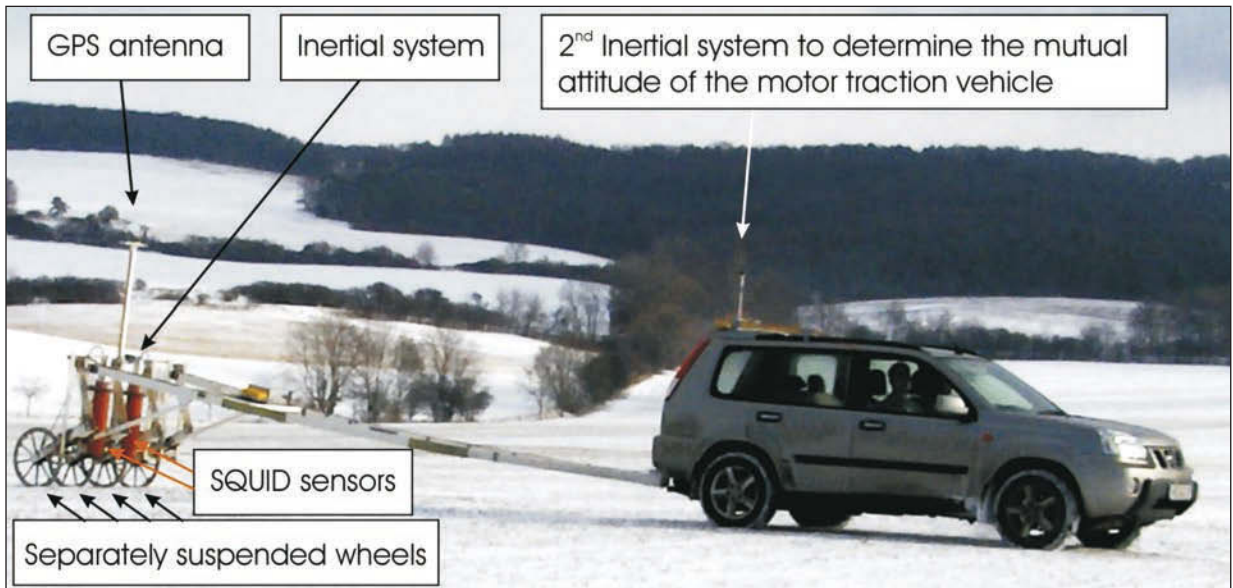

Fig. 1. The measurement cart pulled by a cross-country vehicle.

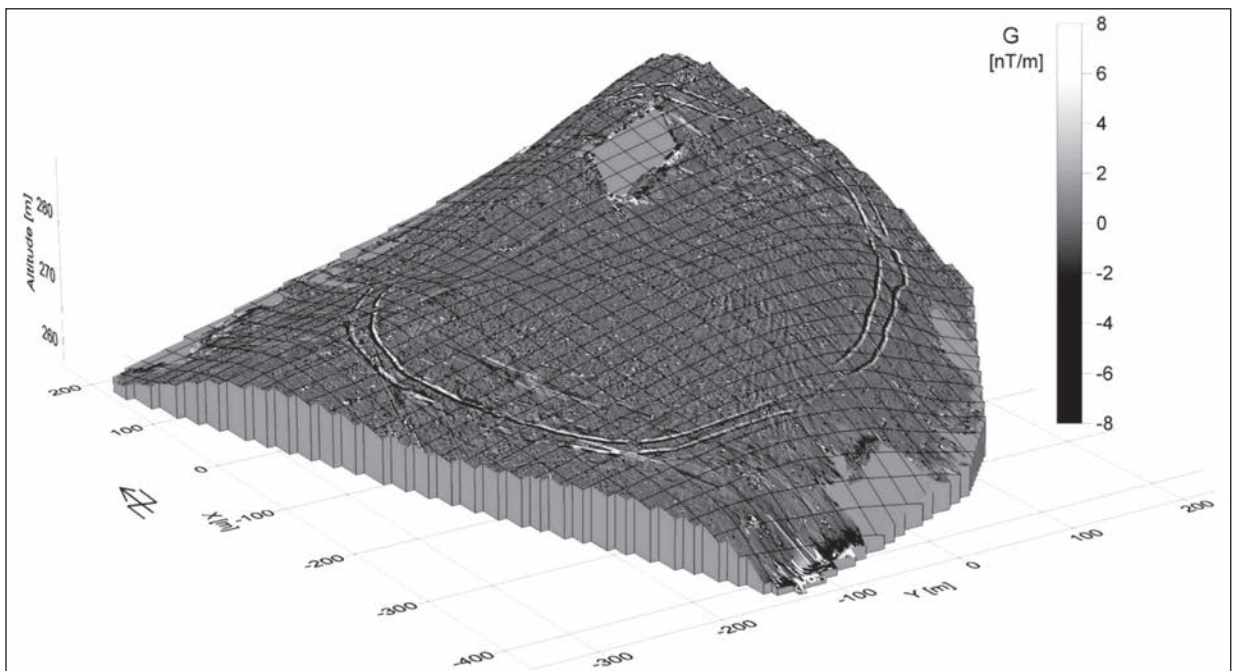

Fig. 2. Magnetic chart of the complete Neolithic double-ring ditch of Niederzimmern, mapped onto the simultaneously measured altitude profile.

magnetometers, the suppression of the gradiometers' parasitic sensitivity to homogeneous fields can be raised up to some 10^7 . With this value, for smooth movement the noise-limited field resolution of the SQUID gradiometers is not disturbed improperly.

SQUIDs have the additional advantage of keeping their sensitivity also for high frequencies. This offered the possibility to set up a measurement system which allows for fast surveying of large areas. This demands an adequate fast and accurate measurement of the sensor position. For this purpose a differential GPS is implemented, consisting of a GPS antenna on the moved cart together with the other sensors, and a GPS reference station with fixed position. Thus, a position accuracy of some centimetres is achieved. However, on uneven terrain the position of the GPS antenna may stagger unacceptably. To calculate the position of the SQUIDs out of the GPS antenna position, the attitude of the cart is measured with an inertial system. All data are stored in a data logger and partially online displayed

on the laptop. Due to GPS the measured magnetic field gradient data are located geo-referenced on the mapped area. Also the altitude profile is provided.

All sensors - two SQUID channels with a distance of 0.5 m, GPS and inertial system - are mounted on a non-metallic cart with separately suspended wheels. This enables smooth movement even at high speeds. With a 4 m long towing bar it is even possible to pull the measurement system with a motor traction vehicle (Fig. 1). With a typical driving speed of about 30 km/h and a distance of 1 m between the driven lines, three hectares can be mapped in one hour. Because the surface does not always allow for such a high speed and the turnarounds add, this may decrease to about 1 ha/h.

The complete measurement system and its parameters are described in more detail in [1]. On areas difficult to access, the cart can be converted to a version pushed manually.

With this system the large Neolithic double-ring ditch of Niederzimmern near Weimar, Germany, with a diameter of 400 m was investigated. This was only possible with our fast measurement system, since the area is intensively agriculturally used, and because of the fragmentation into various fields only winter time with enough snow as protection of the surface can be used to cover the whole area without disruptions. Therefore, the complete ring ditch area of 27 hectares was measured on three winter days.

A picture of the complete double-ring ditch mapped onto the simultaneously measured altitude profile is shown in Fig. 2. A closer look shows periglacial patterns due to the hilly landscape, surface patterns originated by the agriculture, magnetic dirt on the surface and of course several archaeologically interesting features. This is exemplary shown for the north-eastern part in Fig. 3. Part of this area was already measured before with the antecessor version of our system, yet pushed manually. Reference [2] shows the origin of the signal of the ring ditch, the differing susceptibility inside the ditch, which is now refilled.

Remains of palisades and buildings could be found at all four gateways. The large inner area of the 400 m diameter ring ditch was, however, found nearly empty of archaeological patterns. Because of the large size of the ring this was a little bit surprising. The fact can be used for further interpretation and discussion of the purpose of such Neolithic ring ditches.

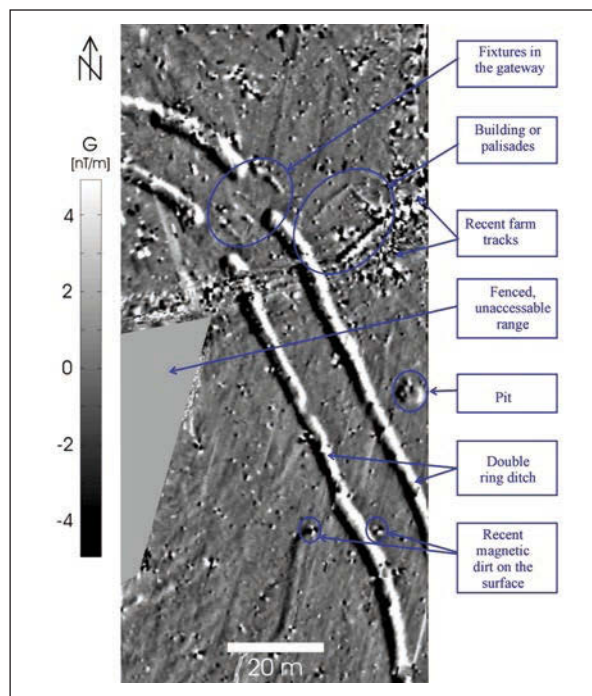

Fig. 3. North-eastern gateway of the double ring ditch.

REFERENCES

Linzen/Chwala/Schultze/Schulz/Schüler/Stolz/Bondarenko/Meyer in print

Schultze/Chwala/Stolz/Schulz/Linzen/Meyer/Schüler in print

S. Linzen/A. Chwala/V. Schultze/M. Schulz/T. Schüler/R. Stolz/N. Bondarenko/H.-G. Meyer: A LTS-SQUID System for Archaeological Prospection and Its Application in Southern Peru. IEEE Trans. Appl. Supercond. In print.
V. Schultze/A. Chwala/R. Stolz/M. Schulz/S. Linzen/H.-G. Meyer/T. Schüler: A SQUID system for geomagnetic archaeometry. Archaeological Prospection 14, in print.

Volkmar Schultze
Sven Linzen
Ronny Stolz
Andreas Chwala
Marco Schulz
Hans-Georg Meyer

Institute for Physical High Technology (IPHT)
Albert-Einstein-Str. 9, D-07745 Jena, Germany
volkmar.schultze@ipht-jena.de
sven.linzen@ipht-jena.de
ronny.stolz@ipht-jena.de
andreas.chwala@ipht-jena.de
marco.schulz@ipht-jena.de
hans-georg.meyer@ipht-jena.de

Tim Schüler

Thüringisches Landesamt für Denkmalpflege und Archäologie
Humboldtstr. 11, D-99423 Weimar, Germany
SchuelerT@tlda.thueringen.de

WHAT ARE THE ADVANTAGES OF SEVERAL MAGNETIC PARAMETERS MEASUREMENTS IN PROSPECTION?

Julien Thiesson - Alain Tabbagh - Michel Dabas

Key words: magnetic viscosity, magnetic susceptibility, electromagnetism, magnetic signal

For nearly 50 years, magnetic prospecting is the most widely used technique in archaeological prospecting and the so-called "magnetic signal" has been widely recognized as a relevant indicator of both pedogenesis and soil anthropisation. It permitted the detection of numerous types of features such as post-holes, ditches, or fireplaces. However, this method has some weaknesses:

- a huge sensitivity to either modern or archaeological metallic ferrous objects
- a small sensitivity to shallow depth lens shaped features
- it corresponds to total magnetization contrasts
- depths of the source bodies is unknown, their maximum values can only be defined

The electromagnetic methods open new paths which overcome these limitations (*Desvignes/Tabbagh 1995*). The measurement of the magnetic susceptibility using frequency domain electromagnetic devices is possible over a soil thickness driven by the device geometry. Given such measurements, one can evaluate the part of induced magnetization in the total magnetic field anomaly and different devices with different geometries permit a proper estimation of both feature depth extents and lateral limit locations. For metallic objects, electromagnetic instruments allow a good precision in their location, which also corresponds to a smaller extent of the "blind zone" where other features are undistinguishable (*Tabbagh 1984*).

Having determined the magnetic susceptibility distribution, it is possible (*Benech et al. 2002*) to calculate the magnetic anomalies due to the induced magnetization and to subtract it from total magnetic field anomalies. The remanent magnetizations can be thus evidenced, which is important because they correspond to undisturbed features. Nevertheless, the kind of remanent magnetization, viscous or thermoremanent, must be known. The differentiation is possible according to the hypothesis that material with "long time" viscous magnetization will likely present "short time" viscous magnetization (the number of comparison is yet limited but all the experiments lead to this conclusion); the direct measurement of the magnetic viscosity (by T.D.E.M. instrument) may permit the discriminating of the two types of remanent magnetization. The ratio of magnetic viscosity to magnetic susceptibility is also informative about the size of magnetic grains. The archaeological significance of this size is not well established yet but this research path merits to be followed.

The use of different techniques has proved to be very relevant in the study of a craft feature on the Roman site of Vieil Evreux, France (*Thiesson et al. 2007*) and on other protohistoric archaeological sites. All these studies show both the interest of associating magnetic and electromagnetic prospecting method and designing a new pulled continuous moving instrument that performs these measurements.

REFERENCES

- Benech/Tabbagh/Desvignes 2002* C. Benech/A. Tabbagh/G. Desvignes: Joint inversion of EM and magnetic data for near-surface studies. *Geophysics* 67, 2002, 1729-1739.
- Desvignes/Tabbagh 1995* G. Desvignes/A. Tabbagh: Simultaneous interpretation of magnetic and electromagnetic prospecting for characterization of magnetic features. *Archaeological Prospection* 2, 1995, 129-139.
- Tabbagh 1984* A. Tabbagh: On the comparison between magnetic and electromagnetic prospecting method for magnetic features detection. *Archaeometry* 26, 1984, 171-182.
- Thiesson/Tabbagh/Flageul 2007* J. Thiesson/A. Tabbagh/S. Flageul: T.D.E.M. magnetic prospecting using Slingram coil configuration. *Near Surface Geophysics* 2007.

Alain Tabbagh
Julien Thiesson
Département de Géophysique Appliquée, UMR 7619 Sisyphe
Université Pierre et Marie Curie, Paris 6, tour 56, couloir 56-46,
4 place Jussieu
75252 Paris Cedex 05, France
alat@ccr.jussieu.fr
Julien.Thiesson@ccr.jussieu.fr

Michel Dabas
TERRA NOVA
16 rue du Sentier
F 75011 Paris, France
dabas@geocarta.fr

GEOINFORMATION SYSTEM (GIS) OF ARCHEOLOGICAL SITES OF NORTHEAST BLACK SEA COAST

Galina V. Trebeleva

Key words: geoinformation system (GIS), archaeological sites, historical modelling, archaeological research, spatial analyst

One of the main priorities of modern archaeology is not only the analysis of the definite sites but also its study in the context of natural and historical landscape. In this connection the archaeological analysis requirements have been changed at present. It is necessary to not only gain information about archaeological site or complex of sites but also to investigate them on the basis of historical, geographical and archaeological information within a particular territory. Archaeologists show more and more interest in such spheres of science as spatial archaeology, system of settling and land tenure, and also in adjacent sciences such as paleogeography, paleoecology and so on.

The first works connected with the GIS creation of archaeological monuments on north-eastern coast of the Black sea were begun in 1998-2000, during the Russian - French Project of Regional Archaeological Taman. A database of archaeological monuments of the Taman peninsula was created, comprising more than 300 objects of the ancient time. It was created on the basis of Microsoft Access. This system was prepared by specialists of the Top school with application of the mathematical and statistical methods in the region, the study by the House of the science of the humanitarian problems (Paris, France). Started in 2001, the work was continued by the Russians, who carried out complex investigations of paleogeography and archaeology on the Caucasian coast of the Black sea. Archaeological monuments of given region have a series of the features. Due to the important changes during the last 30 years, the identification of many monuments became problematic. The natural scenery of many artificial patios has loudly changed. Parts of the monuments disappeared in the area of constructions. The monuments in the riverside area were destroyed as by soil slides and the riverside graze. The slope of the south of the Caucasian loin is hidden by the powerful massifs of forest and of shrubbery. Many of earlier well-known monuments did not have the exact tie in the locality. The Georgian - Abkhasia situation of 1992-1993 was complicated by the consequences of the war. The historical-geographical certificates of the Caucasian coast are fragmentary, and the real contained news of them is alternated with a high quantity of mythological information. Often the situation of an epoch extrapolates very much in other. There are often little localities absolutely fantastic. That is why the concrete geographical information found in literary sources should be accessed cautiously.

On the whole, the works are not finished but the database already includes more than 600 objects. Its geographical territory includes the coast of the Black sea of the peninsula Taman up to the Republic of Abkhasia. Chronologically the monuments reflect the period of the Palaeolithic up to the Middle Ages but they have relations with the period of Antiquity.

Spatial image SPOT as the air photos, the topographic letters of the scale from 1:100 000 up to 1:10 000 were used as the topographic base of GIS. As the system of coordinates it will use projection UTM with the model of the Earth WGS-84 basic along with the work with the GPS-recipients. Election of the model of the Earth based on the aspiration to create the maximum technological process faced directly to dad GPS recipients, to the system of information used for the direct interactive application in large conditions.

The work under GIS creation is not finished, but in spite of this there is already now a series of interesting examples of application of given GIS in the analytical targets. For example, an attempt to create the model of defence organization of the kingdom of Bospor in the Roman period has already been made.

Galina V. Trebeleva

Institute of Archaeology of Russian Academy of Sciences
60-let Oktiabria h. 20 ap. 23
117036 Moscow, Russia
g_gis@mail.ru

MAPPING OF SWEDEN'S FIRST TOWN BIRKA USING GEORADAR AND MAGNETOMETER PROSPECTION

Immo Trinks - Lars-Inge Larsson - Alois Eder-Hinterleitner

Key words: georadar, GPR, magnetometer, prospection, Viking age

Geophysical archaeological prospection allows for detailed mapping of structures that are hidden in the sub-surface. In particular high-resolution georadar (Ground Penetrating Radar/GPR) and magnetometer measurements can be used very efficiently for the non-destructive survey of large areas in short time and at relatively low costs. In Central Europe and the United Kingdom the use of geophysical archaeological prospection methods is relatively common and enjoys an increasing popularity among archaeologists. In Scandinavia, however, these methods have so far been used to a much lesser degree, often at a low technical level and only on very small areas.

Since the beginning of 2005, a professional archaeological prospection unit has been set up within the Archaeological Excavation Department of the Swedish National Heritage Board in close collaboration with internationally leading experts in the field. A comprehensive series of test measurements has been conducted in Sweden, demonstrating the successful applicability of both magnetometer and georadar prospection methods to Scandinavian archaeological sites under suitable geological and environmental conditions.

In May 2006, an archaeological prospection test survey was conducted in the course of four days at the UNESCO world cultural heritage site Birka-Hovgården resulting in data of exceptional high quality. Roads, houses, property plots, an outer and an older inner town wall as well as the varying thickness of the cultural layer have been mapped in great detail in the test areas.

Birka, located on the island of Björkö in Lake Mälaren 35 km west of Stockholm, is one of the best known archaeological places in Sweden, visited every year by thousands of tourists. The settlement and trading place Birka existed for approximately 200 years between 750 and 950 AD. Birka is considered to have been the first real town in the area that is Sweden today. Archaeological finds show that it was an important market place during the period commonly known as Viking age, with far reaching trading connections and a home to skilled craftsmen.

Despite several archaeological investigations undertaken in the last century we still know very little about Birka. Only small areas have been investigated through destructive archaeological excavation (less than 1% of the town area). Earlier geochemical and geophysical prospection surveys at Birka have not resulted in any significant new archaeological knowledge about the site and its development. As the site has been left relatively undisturbed since the town of Birka was abandoned 1000 years ago, the preservation and prospection conditions are excellent. Agricultural land use caused no deepgoing disturbances and left the cultural layer widely intact below plough depth.

A part of the Viking age town wall is still visible as topographical feature in the landscape. Since this wall ends abruptly, it had been unclear whether it actually continued all the way to a nearby hill-fort. In order to investigate

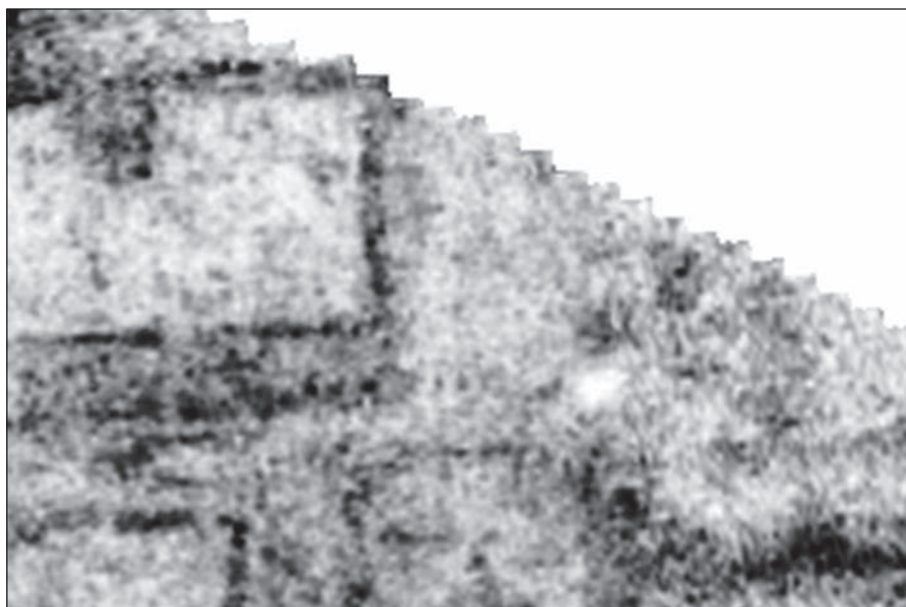

Fig. 1. View across the Black Earth of Birka from the town wall in the east to the hill-fort in the west. The field between the hill-fort and the town wall was during the Viking age (750 to 950 AD) home to a lively trading place, covered with houses, huts, workshops, roads, fortifications and harbour constructions.

the possible continuation of the town wall in a meadow where several large stones stick through the surface, a small magnetometer survey was conducted. By surveying a 50 m by 50 m test square it was possible to determine that a linear band of highly magnetic anomalies crossed the test area, connecting the end of the visible town wall with the hill-fort along the assumed course of the fortification. The observed anomalies are believed to be caused by large stone blocks in the subsurface that once formed the fundament of the town wall. The result of the magnetometer measurement is the first proof that the today still visible town wall once actually continued all the way to the hill-fort. A weak linear anomaly outside the wall could not be identified with certainty as an accompanying Viking age fortification trench since historical maps from the 17th century show a ditch at the same location.

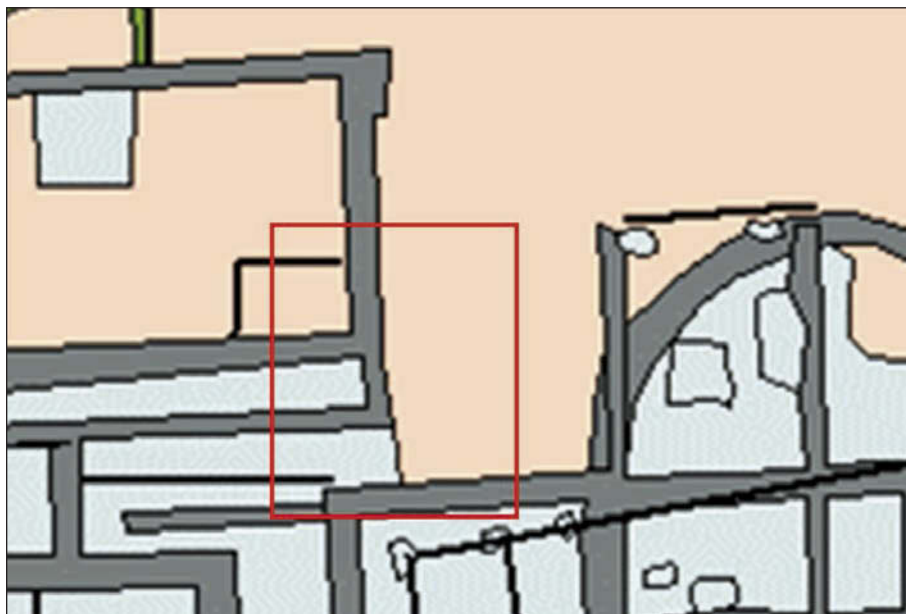

Fig. 2. Magnetometer survey with four Förster gradiometer probes mounted with 50 cm spacing into a manually operated cart (top image). Georadar survey using the *Sensors&Software Noggin-Plus* 500 MHz antenna system mounted in the *SmartCart* (bottom image).



Fig. 3. View of the magnetometer survey area across the outer town wall (top). The magnetometer prospection data showing the fundament of the town wall as linear band of highly magnetic anomalies (bottom left) and interpretation (bottom right).

As second test site a 50 m by 100 m measuring rectangle was chosen centrally in the old town area for high resolution georadar measurements. Due to the occurrence of particularly dark soil this area is called "Black Earth". Since an approximate thickness of 2.5 m of the cultural layer a 500 MHz *Sensors & Software NogginPlus* antenna system mounted in a *SmartCart* was chosen. The survey was conducted along 50 m profile lines with 5 cm inline trace spacing and 25 cm crossline spacing. Two people working in the field were able to survey one 50 m by 50 m square in one day. A three-dimensional data volume was generated, filtered and subsequently sliced into 5 cm thick horizontal depth-slices under the simplifying assumption of a constant velocity of 10 cm/ns for the entire subsurface. Below a depth of 40 cm a great number of distinct archaeological structures becomes visible: the fundamentals of houses, property boundaries, roads and paths, trenches and a second, inner and older town wall including a gate and possible gate building. The thickness of the cultural layer varies considerably across the survey area, being thickest in the north-west where the oldest part of Birka is assumed to be located at the bottom of the cultural layer in vicinity of an old bay with harbour constructions. Towards the east the cultural layer is thinning. Outside the older town wall considerable fewer anomalies in a much thinner layer are visible in the georadar data. The old town wall appears partly as band of reduced reflectivity. It is therefore interpreted as clay wall/ridge. This wall is interrupted by a port through which a road is leading. The wall changes its appearance in the west where it possibly had the form of a palisade.

After discovery of the older town wall in the georadar data this structure became recognisable in satellite and aerial images as well. The road leading through the older wall can be seen in orthophotos to continue into the magnetometer test area, indicating a second gate in the outer town wall.

The georadar data from different depths shows how Birka developed over time. The overlapping of structures visible in the data allows in some cases their relative dating.

This archaeological prospection test illustrates how georadar and magnetometer measurements can be used very successfully to map the Viking age town Birka.

Immo Trinks
 Lars-Inge Larsson
 Swedish National Heritage Board, Archaeological Excavation Department
 Instrumentvägen 19
 126 53 Hägersten, Sweden
 immo.trinks@raa.se
 lars-inge.larsson@raa.se

Alois Eder-Hinterleitner
 ZAMG Archeo Prospections
 Hohe Warte 38
 A-1190 Vienna, Austria
 alois.eder-hinterleitner@zamg.ac.at

GEOPHYSICAL PROSPECTION AND ARCHAEOLOGICAL FEEDBACK IN RESCUE ARCHAEOLOGY – EXAMPLES FROM SWEDEN

Immo Trinks - Lars-Inge Larsson

Key words: georadar, GPR, magnetometer, prospection, interpretation, excavation

Until recently, rescue archaeology in Sweden had been conducted through partial trenching of sites during pre-investigations, which were followed by large scale excavations if archaeological material was found. Under the right conditions geophysical prospection can add valuable information to archaeological site investigations in a time and cost effective manner. Since 2005, archaeological prospection using high-resolution magnetometer and georadar measurements has been tested by the Archaeological Excavation Department of the Swedish National Heritage Board as a tool for rescue archaeology in Sweden.

The aim of this paper is to demonstrate the potential and pitfalls of geophysical archaeological prospection based on the archaeological feedback obtained through excavation of the prospected sites. We will present two case studies in which georadar (GPR), or magnetometer prospection was used to investigate archaeological sites threatened by development. The archaeological problem, field work and data interpretation will be discussed, followed by a comparison of the prospection results with the findings of the subsequent archaeological excavation. While good agreement between structures discovered using geophysical measurement techniques and those found in a later excavation is pleasing and may be suited to convince archaeologists of the benefits of the approach, disagreement or impossibility to detect structures that actually exist in the ground can cause doubts in applicability of geophysical methods, particularly if a survey is conducted as part of a commercial enterprise. Ideally an archaeological prospection survey results in data showing anomalies that are interpretable and attributable to natural or man-made structures in the subsurface. Often the exact cause for many anomalies visible in the data is unknown and may only be possible to ascertain the presence of "something" in the subsurface. Information about the presence or absence of distinct anomalies can in itself be of value to archaeological investigation. However, the lack of positively interpretable structures in the data can lead to disappointment among archaeologists or the contractor of an archaeological prospection survey. Therefore, not only the understanding of physical causes for the presence or absence of anomalies in the prospection data is of great importance, but also the way of communicating the strengths and weaknesses of the method, and the outcome of the geophysical survey.

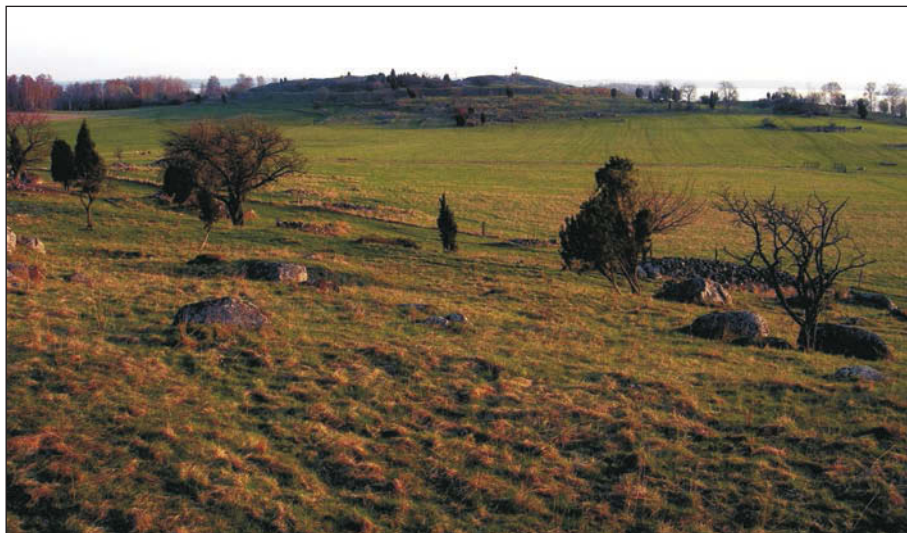

Fig. 1. Georadar depth-slice of the data measured with 25 cm profile spacing. Compare this image with the interpretation and excavation results shown in Figs. 2 and 3.



Fig. 2. Interpretation of the georadar data shown in Fig. 1. The excavated area shown in Fig. 3 is marked with a red box.

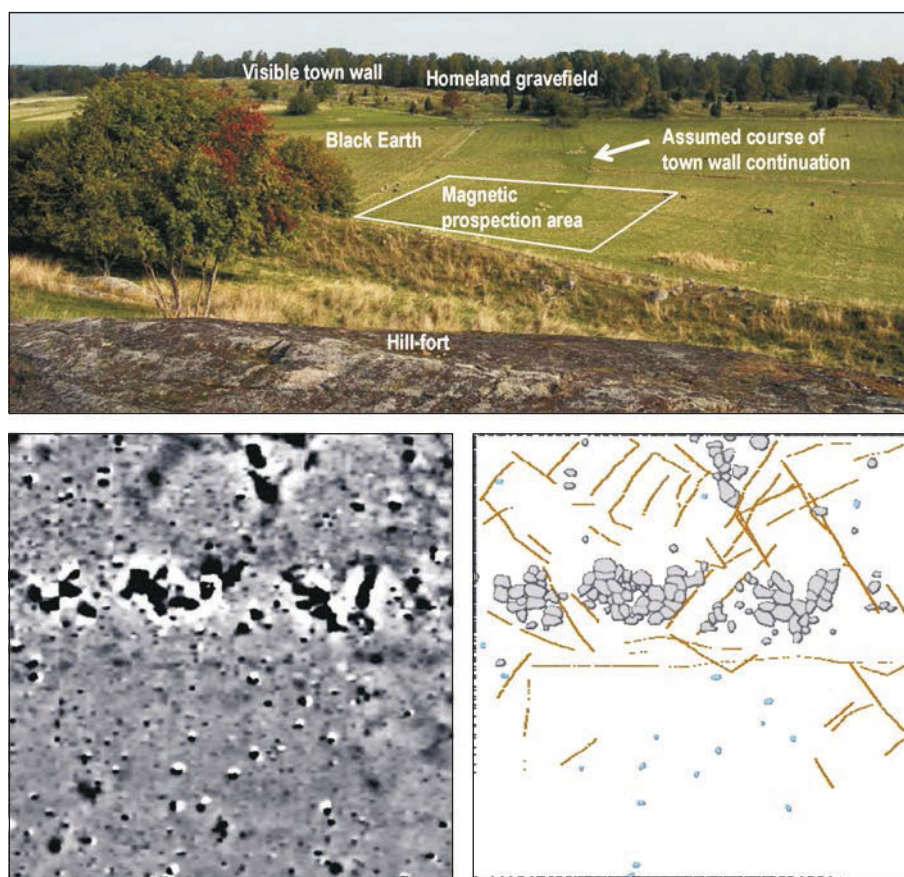

Fig. 3. Photo showing the excavated area. The natural stone and brick walls are clearly recognizable in the georadar data and in its interpretation in Figs. 1 and 2 (Photo: Magnus Stibéus).

The first example will discuss the georadar survey of the medieval St. Olof convent in Skänninge (Östergötland County). The extension of the railway track Motala-Mjölby in Östra Götaland from single to double track led to archaeological excavations in Skänninge from 2002 to 2006. Along the railway track massive foundation walls of the medieval St. Olof's convent came to light. Due to the well preserved stone structures in the ground this site was considered ideal to test and demonstrate the potential of high-resolution georadar measurements for archaeological prospection. To this purpose the *Archeo Prospections* team from Austria was invited in 2004 to conduct georadar measurements on the area neighbouring the excavation site. A total area of 7,000 square metres was surveyed by measuring with a *Malå Geosciences* 500MHz georadar system along parallel profiles with 50 cm crossline and 5 cm inline trace spacing. The resulting georadar images show in great detail the reflections of the radar signal from the foundation walls of the entire medieval convent in the ground. The archaeological interpretation of the georadar data revealed the layout of the entire convent, including an inner court yard with cloister and presumably the convent church. The archaeological prospection survey allowed the archaeologists to gain an overview across the entire site and to put the results of the excavation into bigger picture. It is important to understand that the georadar data represents a summary of all structures in the subsurface, independent of their age and construction date. From the georadar data alone it is in general impossible to date the structures, or to deduce the order of construction during the 300 years of the existence of the convent. Archaeological prospection helped to add a large amount of valuable information to the archaeological investigation at little extra costs and in very short time. In spring 2006, the central area of St. Olof's convent was surveyed by *Sensors & Software NogginPlus* 500 MHz georadar system and 25 cm crossline profile spacing. In summer 2006, research excavation was conducted over some of the structures identified in the georadar data. The excavated structures agree very well with the anomalies seen in the georadar data.

The second case will highlight differences between results obtained through magnetometer prospection and those obtained from archaeological excavation of an iron-age settlement and iron production site at Harbo (Västmanlans County). This study demonstrates the strength and weakness of the magnetic prospection method under challenging geological (unsorted moraine) and archaeological conditions. The visibility and invisibility of archaeological structures in the magnetic data is addressed on the basis of magnetic susceptibility measurements conducted on the excavated surface.

Immo Trinks
 Lars-Inge Larsson

Swedish National Heritage Board, Archaeological Excavation Department
 Instrumentvägen 19
 126 53 Hägersten, Sweden
 immo.trinks@raa.se; lars-inge.larsson@raa.se

NON-DESTRUCTIVE ERT SURVEY AT THE SOUTH WALL OF ACROPOLIS OF ATHENS

Gregory N. Tsokas - Panagiotis I. Tsourlos

*Key words: non-destructive, ERT, flat base electrodes, acropolis, Athens***Introduction**

Very few attempts to apply resistivity measurements in a non-destructive manner are described in geophysical literature (Carrara *et al.* 2001). More recent systematic studies indicate that by using appropriate materials as electrodes, ERT can be efficiently applied in a fully non-destructive manner.

This work describes the application and results of a fully non-destructive large scale ERT survey that was conducted at the south wall of Athens Acropolis. The Acropolis hill is certainly the most important site of Athens and probably the most important archaeological site of Greece. It is situated on a precipitous hill 160 metres above sea level. The site was already occupied in the 17th century B.C., and took its final shape during the 5th century B.C. (Golden Era). It hosts masterpieces of Ancient Greek architecture such as the Parthenon and is surrounded by a thick wall with thickness up to 5 m. The south Acropolis wall has been built at the beginning of the Golden Era and since then it withstood several additions, excavations and repairs even until recently (beginning of the 20th century) which altered its original masonry (Stewart/Korres 2004). The south wall has been distorted due to the pressure of the fill behind it. Further areas of increased moisture show up, which threaten the integrity of the construction. As part of an extended conservation and restoration project of the circuit walls of the Acropolis undertaken by the Acropolis Restoration Service, the application of geophysical techniques was considered useful for gaining a better insight into the structure of the south Acropolis wall.

The project had to face unusual technical (mounting the cable on the external wall) and processing challenges (wall-to-surface, cross-wall measuring modes), yet the final results suggest that ERT can be used successfully in this type of surveys.

Field Survey

Several 2D ERT sections were collected at the south Acropolis wall using different measuring modes: wall-to-surface (Fig. 1a), vertical on the wall (Fig. 1b), horizontal on the wall surface and on the surface of the hill (Fig. 1c). Further, due to the existence of a few open pits it was possible to collect cross-wall ERT data (Fig. 1d). The cable was fitted on to the external wall by two experienced climbers (Fig. 2 left). Wet bentonite in a plasticine form was stack on the wall and was used as electrode (Fig. 2 right) while the cable was tag-taped on to the wall to avoid cable movement due to the wind. Electrode positioning on the wall was assisted by a surveyor positioned at

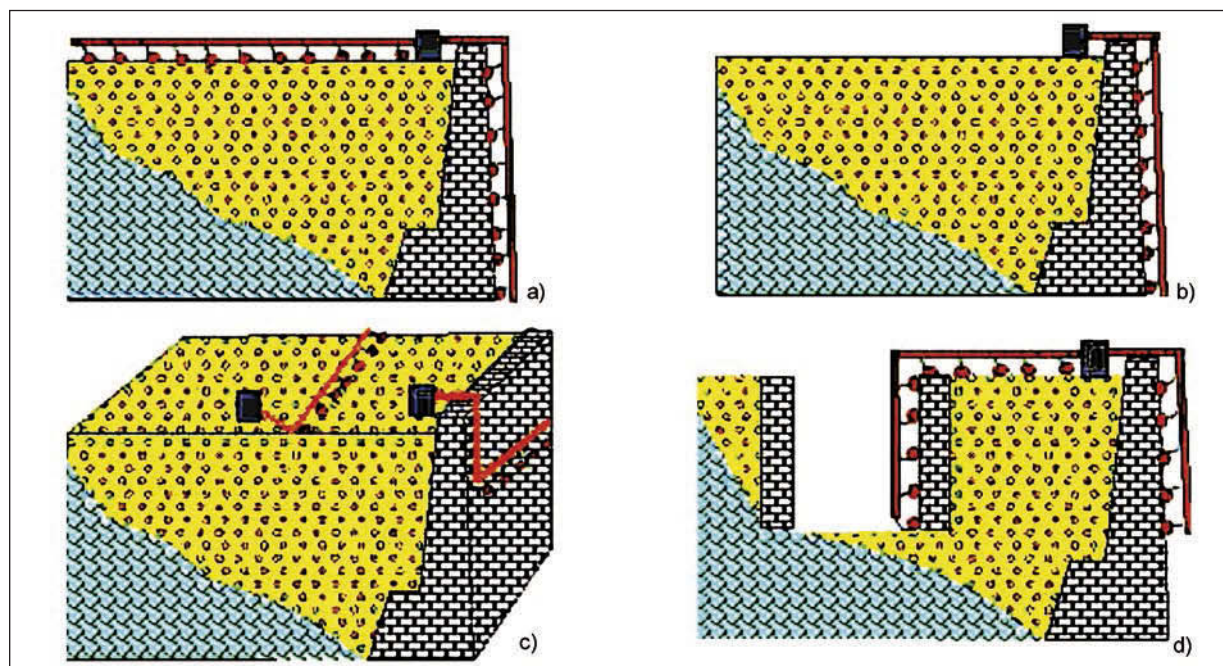

Fig. 1. Measuring modes used.

the foothills of the Acropolis. The electrode spacing was 1m for all measured sections and data were obtained either using the Wenner-Schlumberger or the dipole-dipole array depending on the quality of the signal. Relatively low conduct resistances (typically 1-2 KOhms) allowed the collection of good quality measurements.

A total of 20 2D ERT lines were collected along the wall. To verify that bentonite electrodes perform equally well to standard electrodes a test was conducted in an area where we were allowed to insert electrodes into the ground. The relative deviation of the measurements using different electrode types was 2.7%.

Processing and Results

Standard 2D inversion software (*Tsourlos 1995*) was used for processing the wall and surface data-sets. Yet for the wall-to-surface measurements the inversion software was modified to cope with this type of measurements: the finite element mesh initially designed for borehole-to-surface ERT measurements was modified by assigning very



Fig. 2. Climbers fitting the cable on the wall (left), bentonite electrode (right).

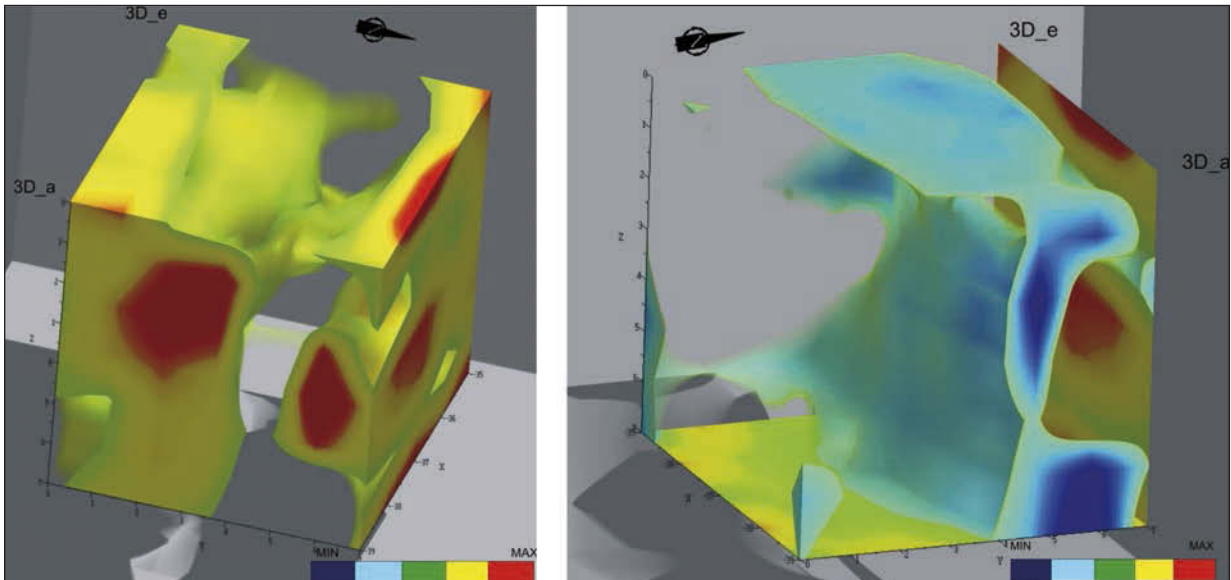

Fig. 3. 3D inversion results of the cross-wall ERT sections.

large resistivities (10^9 Ohm-m) to simulate the effect of the air on the wall electrodes. Finally, the reconstruction space was decided after a model resolution analysis. Similar modifications were applied to a 3D inversion code to invert the cross-wall ERT data which were dense enough (5 sections 1m apart) to be processed in a full 3D fashion. The central and east part of the wall appears to have areas of very low resistivity indicative of high moisture content. This is attributed to the drainage system which is not fully mapped yet. In Fig. 3a, 3D resistivity volume (low and high resistivities) produced after the 3D inversion of 5 dense cross-wall ERT lines is presented. The wall structure and the filling material are clearly depicted.

Conclusions

In this work the ERT technique was applied for the first time in a fully non-destructive manner to image the interior of the south wall of Athens Acropolis. It is showed that this type of survey is perfectly feasible and can produce results which give informative images to archaeologists and restoration scientists.

Gregory N. Tsokas
Panagiotis I. Tsourlos
Exploration Geophysics Lab.
Dept. of Geophysics
Aristotle University of Thessaloniki Panepistimioupolis
54124 Thessaloniki, Greece
gtsokas@geo.auth.gr
tsourlos@geo.auth.gr

ARCHAEOLOGICAL PROSPECTION BY MEANS OF FULLY NON-DESTRUCTIVE DC RESISTIVITY SURVEYING

Panagiotis I. Tsourlos - Gregory N. Tsokas

Key words: non-destructive resistivity prospecting, flat base electrodes, non-destructive DC prospecting, non-destructive ERT, resistivity prospecting

Introduction

The application of flat base electrodes in performing geoelectrical measurements is examined. This study is motivated by the inability to use geoelectrical techniques in grounds where it is not possible to insert conventional electrodes. The performance of flat base electrodes is examined in various environments, using different measuring modes, and proved to be working satisfactorily in most cases, producing data almost identical to the measurements obtained using standard electrodes.

Comparison between conventional and flat base electrode measurements

Over the last decade there has been a particular interest in studying techniques, such as the use of flat base electrodes, which permit the application of resistivity measurements in a non-destructive manner (Carrara *et al.* 2001) and expand in this way the use of ERT in other environments (e.g. urban).

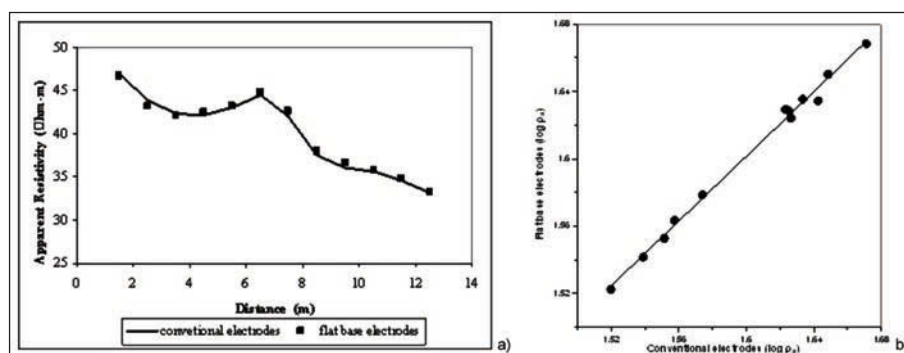

Fig. 1. (a) Resistivities acquired from conventional and flat base electrodes. (b) Correlation between the logarithmic apparent resistivities measured using the two electrode types.

In an attempt to study the performance of flat base electrodes several field tests were carried out using flat base copper electrodes. To decrease the contact resistances a conductive cellulose gel was placed between the electrodes and the ground (*Athanasiou 2006*). Also, various other methods to decrease the contact resistivity were tested. In particular, the use of bentonite produced satisfactory results as well.

Different arrays with varying spacing were measured employing both electrode types over the same positions; i.e. the centres of the flat base electrodes were placed at exactly the same spots where conventional electrodes had been previously inserted. A typical example is shown in Fig. 1a where the results acquired from flat base and standard electrodes are depicted. They exhibit very good correlation (Fig. 1b) with a relative error below 1%.

Tests indicate that this electrode type can be used to investigate the subsurface under concrete, cement pavement, marble plates etc. Good contact resistances were routinely encountered (usually less than 1 KOhm) resulting into very good data quality. However, the technique fails to work over tarmac. Several field surveys were carried out either using both conventional and flat base electrodes or by employing flat base electrodes over areas of known subsurface structure. One representative field application is presented below. The tomographic data were interpreted using a fully automatic 2-D inversion algorithm (*Tsourlos 1995*) based on the “smoothness constrain” principle.



Fig. 2. The left part shows the Roman pipe being cut when the trench was opened for the foundations of a modern building. The line of the flat base electrodes used along with the multicore cable. The arrows depict the tomographic transect.

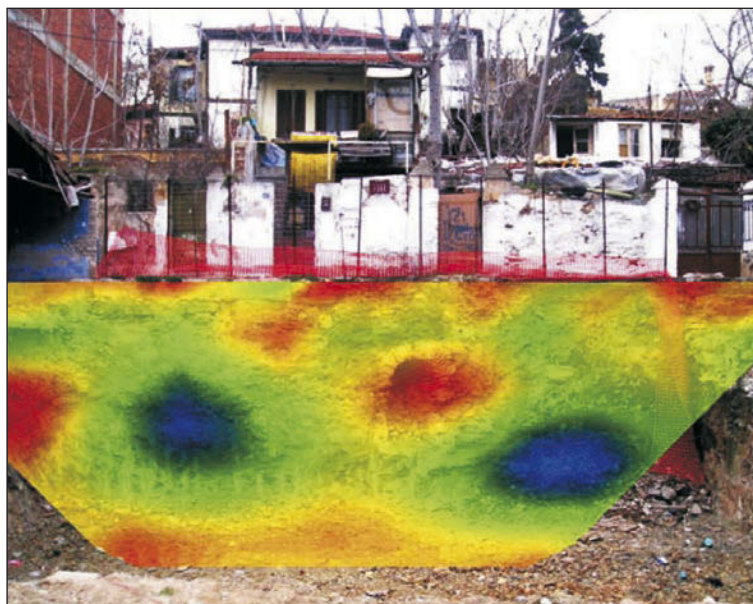

Fig. 3. The resistivity tomography superimposed on the photograph of the side of the trench.

Application

An ancient water supplying brick lined tunnel is laid under a concrete pavement and it was exposed in a trench pit dug for the foundations of a modern building. An electrical resistivity tomography was carried out on top of the concrete pavement as shown in Fig. 2. Various electrode arrays were tested employing 24 flat base electrodes spaced 1 m apart. The maximum n-separation was set to 7. The tomographic transect was at a distance of 2.3 m from the trench.

By comparing the exposure of the side of the trench to the geoelectrical combined weighted inverted model (Fig. 3), it is clear that the pipe is successfully detected.

Conclusions

The tests performed in this study indicate that results obtained with flat base electrodes are in good agreement with the ones obtained with conventional ones. They operate in most environments and surface materials except asphalt. Moreover, tests with various electrode arrays indicate that the subsurface geoelectrical structures imaged via flat base electrodes are clearly depicted. Flat base electrodes can also be used in combination with standard electrodes in cases that otherwise would result in incomplete resistivity data sets.

Panagiotis I. Tsourlos

Gregory N. Tsokas

Exploration Geophysics Lab., Dept. of Geophysics,
Aristotle University of Thessaloniki

Panepistimioupolis

54124 Thessaloniki, Greece

tsourlos@geo.auth.gr

gtsokas@geo.auth.gr

GEOPHYSICAL PROSPECTION OF THE SCYTHIAN FORTIFICATION OF BELSK (BOĽŠOE BELSKOE GORODIŠČE)

Burkart Ullrich - Henning Zöllner - Sergey Makhortykh - Michail Orliuk - Renate Rolle

Key words: Scythians, kurgan, geophysics, geomagnetics

The enormous Belsk hill fort and the surrounding kurgan cemeteries have been investigated by means of geophysical prospection and topographic surveying methods since a Ukrainian-German joint project started in 2002. Geomagnetic mapping was carried out on an area of 30 ha, i.e. almost half of the total area of the hill fort (65 ha). An array of five fluxgate magnetometers was used for the geomagnetic measurements. The system was mounted on a fibreglass frame and carried while walking. Additionally a prototype of a sled supported system was tested in order to make the investigation of this large site more efficient.

The results of the geomagnetic mapping proved the existence of Scythian burial mounds in the surrounding area of the hill fort for the first time. The thereby localised tumuli most probably hold tombs of high-rank members of the Scythian society. In two necropolises, Skorobor and Marchenki, special circular structures called "maidans" were investigated (maidan Ukrainian, Persian = site, special place). The geomagnetic mapping results brought to light that those conspicuous round areas represent the remains of destroyed burial mounds, i.e. of kurgans of significant size. For instance, a circular ditch surrounding one of the destroyed Kurgans at Skorobor necropolis had a diameter of 100 m. Levelling for agricultural purposes, looting and saltpetre extraction were the main reasons for the destruction of the kurgans.

On the Marchenki field a big kurgan was the objective of archaeological excavation as well as of further geomagnetic prospection. After having removed a layer of 1 m thickness, the magnetic measurements were repeated, this time applying a higher density of measurements. Additionally, samples of the filling of the burial chamber and of the surrounding soil layers were taken to determine magnetic susceptibility. Afterwards the geomagnetic field data were compared with the results of model calculations, with a view to improving the interpretation techniques for identifying and localising kurgans and their burial chambers.

Another noticeable result of the geophysical investigations at Belsk hill fort between 2004 and 2006 was the discovery of several alignments of strong circular geomagnetic anomalies in the Zapadnoe (western) fortification. These groups of two or three single round dipole anomalies are situated along the inner rampart. The conclusion drawn from excavation results and from the study of historical sources was that the anomalies show fireplaces used to boil the nitrous soil (Chernozem), especially the earth of the rampart and the kurgans, to extract saltpetre, an important raw material for gunpowder production in the 17th and 18th centuries.

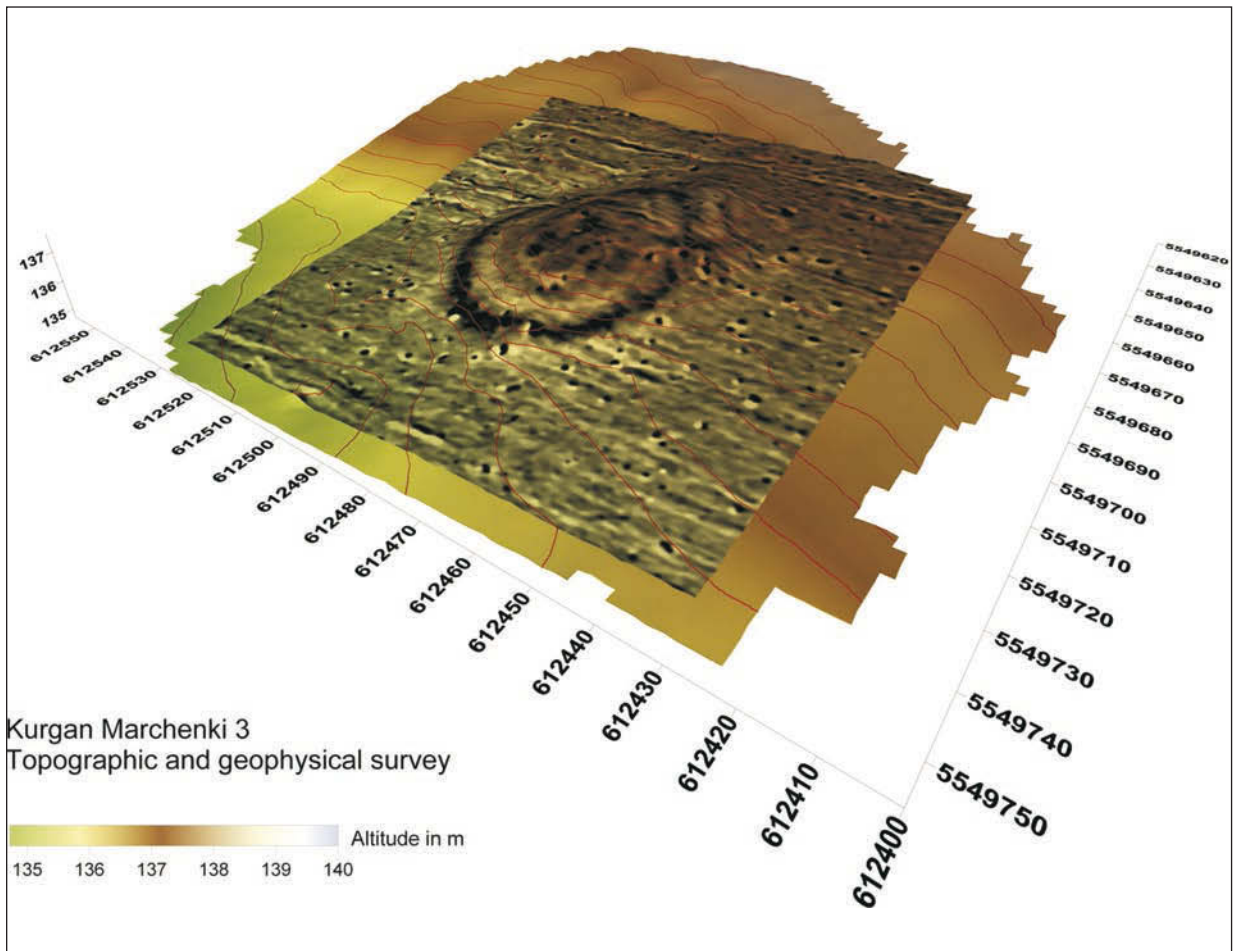

Fig. 1. Kurgan Marchenki 3.

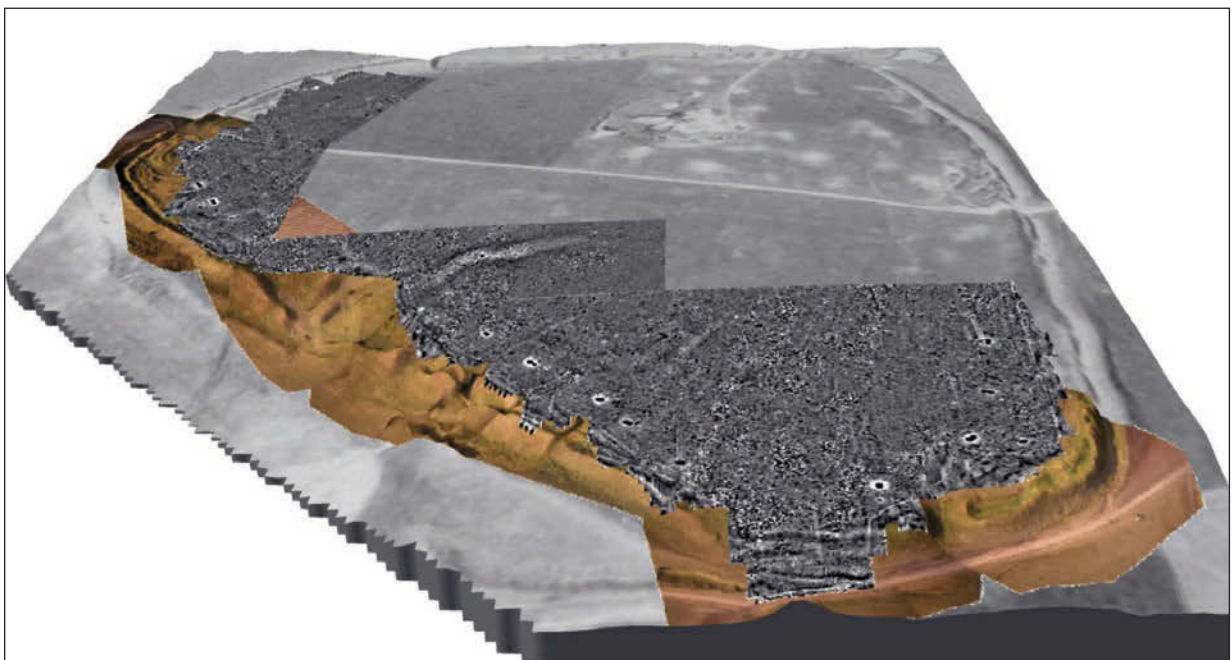

Fig. 2. Overlay of aerial photographs and geomagnetic mapping on Zapadnoe (Western) fortification (Greyscale: ± 6 nT/m).

Results of the geophysical and topographical investigation of this unique archaeological site of Belsk have immensely contributed to the knowledge of ancient customs and the social structure in the Middle Vorskla basin, one of the most advanced regions of the extensive Scythian settlement area between the 7th and 5th century BC.

Burkart Ullrich
Henning Zöllner
Eastern atlas Geophysikalische Prospektion
Große Hamburger Str. 17
10115 Berlin, Germany
ullrich@eastern-atlas.com
h.zoellner@eastern-atlas.de
info@eastern-atlas.com

Michail Orliuk
Institute of Geophysics, National Ukrainian Academy of Science
Palladina Prospekt 32
03680 Kyiv, Ukraine

Sergey Makhortykh
Institute of Archaeology, National Academy
of Sciences of Ukraine
ave. Gerojev Stalingrada 12
04210 Kyiv-210, Ukraine

Renate Rolle
Universität Hamburg, Archäologisches Institut,
Johnsallee 35
20148 Hamburg, Germany
renate.rolle@uni-hamburg.de

AERIAL PROSPECTION IN MORAVIA

Jaromír Kovárník

Key words: Moravia, Aerial Prospection

The application of aerial archaeology brings in Southern, Central and Northern Moravia many effective results. Inspired by O. Braasch (*Braasch/Christlein 1982*), the author started to use the systematic aerial prospection in the year 1982 (*Kovárník 1985; 1986*). The research is focused mainly on the territory of Southern Moravia, especially the regions of Central and lower Dyje and Svatka river basins and lower Morava basin, Jevišovka, Rokytná and Jihlava river

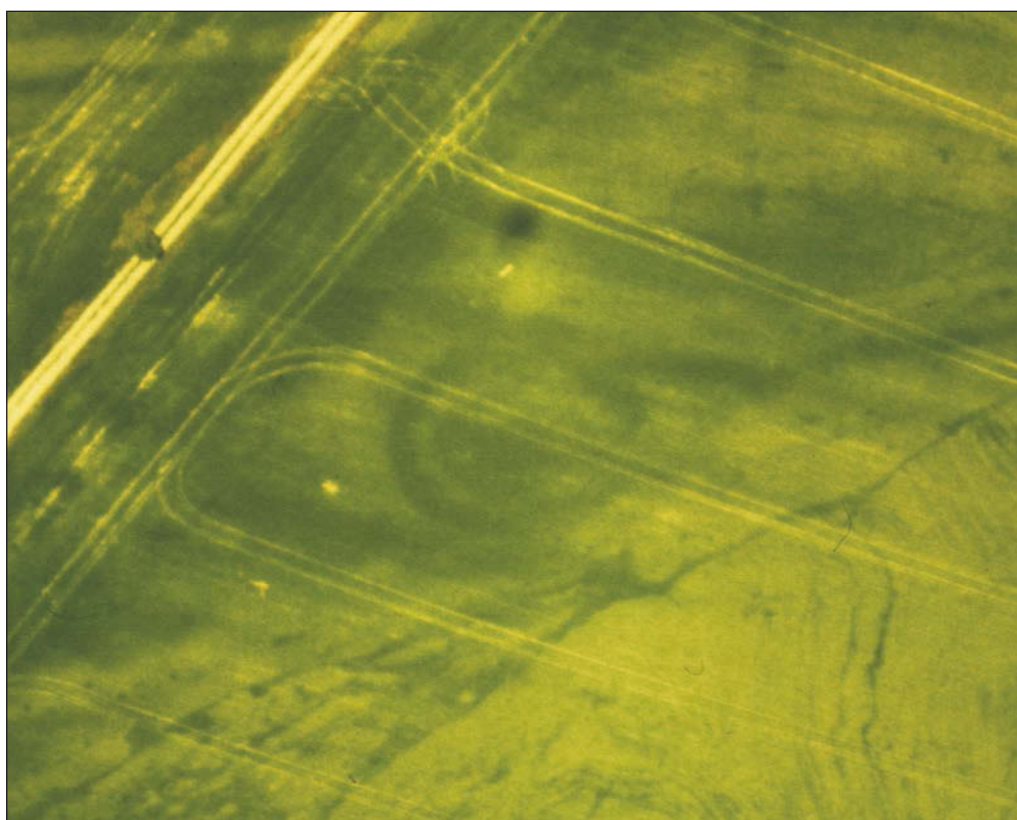

Fig. 1. Trstěnice-Karolina mansion, distr. Znojmo. Ring ditch.



Fig. 2. Přítluky, distr. Břeclav. Pit alignments, cropmarks.



Fig. 3. Derflice, distr. Znojmo. Distinct crop marks of a rectangular ditch with one or two entrances.

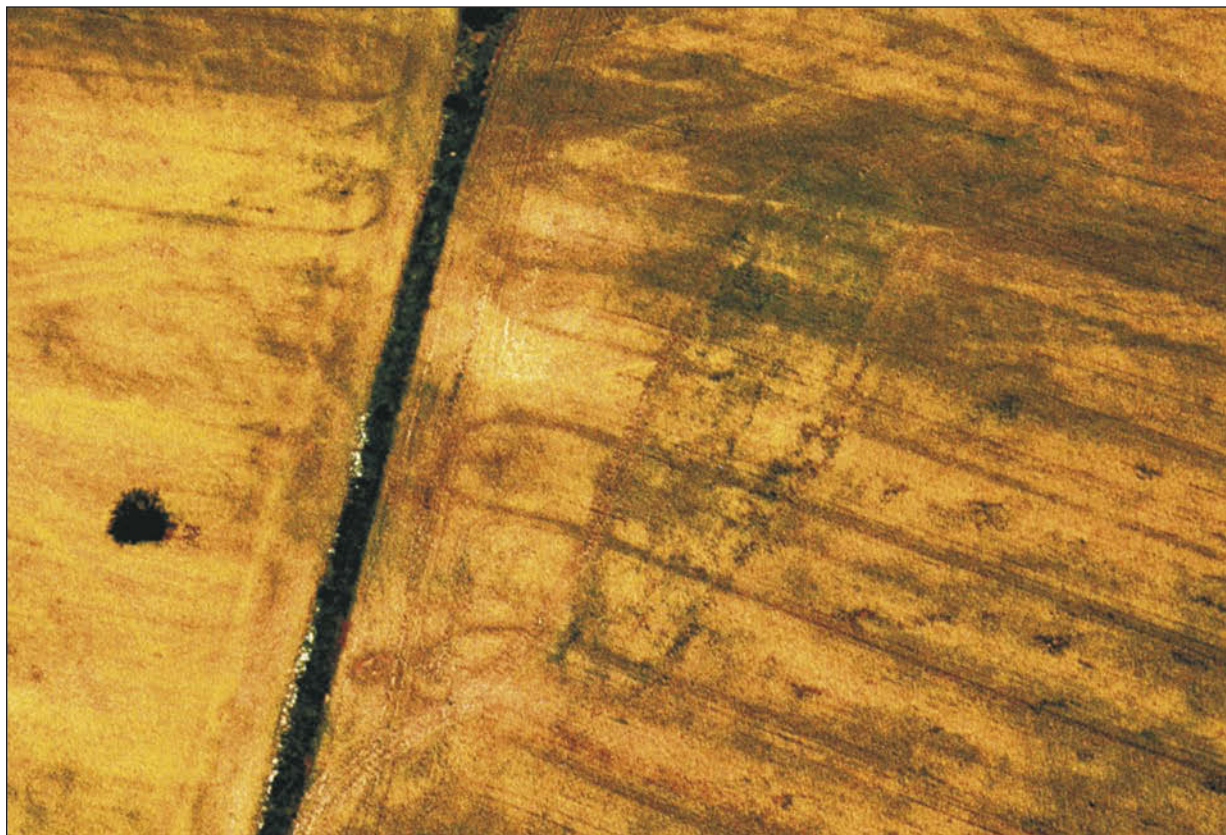

Fig. 4. Hrušovany n/J, distr. Znojmo. Trapezoid-shaped ground plan of a long house, cropmarks.



Fig. 5. Podivín, distr. Břeclav. Group of rectangular ground plans of houses.



Fig. 6. Charvátská Nová Ves, distr. Břeclav. West Front of Roman temporary camp.



Fig. 7. Znojmo-Oblekovice, distr. Znojmo. Large burial-ground, cropmarks.

basins and Krumlovský les, Ždánický les and Chřiby highlands. Some of prospection flights are made in autumn and winter, but most of them in spring and summer months. Analytical surface survey offers data on the cognition of the structure of past landscapes and settlement dynamics in prehistory. The aerial reconnaissance includes the study of the density and distribution of single settlement. Aerial prospection contributed, apart from other things, to important knowledge about number of pits, houses or graves in a certain area. The author documented in cadastral district of village Trstěnice, Znojmo district, three graves with circular ditches and more than 190 indicants (indubitable archaeological features) on the large area of about 28 hectares, which amounts to almost seven features per area of 1 hectare. Therefore it is necessary to verify their cultural belonging for demographic and statistical research (to what extent it is possible to reckon single or polycultural settlement in the locality and exploiting of the sources of the monitored microregion in the certain period of prehistory or protohistory).

Crop and soil marks of many possible archaeological features and monuments have been detected: settlement sites (localities), traces of deserted medieval villages, other hill forts, various prehistoric (Trstěnice: Fig. 1; Vedrovice, Znojmo district, Linear Pottery Culture) and post-prehistoric (Derflice, near of Znojmo: Fig. 3; exact dating can only be provided by excavation) ditches, i.e. fortifications of various types and dating. Very interesting are pit alignments (Ivaň, Příkladky: Fig. 2, Břeclav district).

Crop marks of long rectangular houses with drain-outlined ground plans have also been taken (e.g. in the neighbourhood of the village Jevišovka IV, Vranovice, distr. Břeclav, Zastávka, Brno-venkov district etc.). Vegetation has only allowed tracing parts of ground plans with one gable wall. A long trapezoid ground plan appears to be a regularly as a ground cover pattern on neighbouring plots, which belong to the cadastral district of Hrušova n/J (Fig. 4). Our finds also include an interesting ground plan located in Drnholec "Holenická pole", possibly formed by footing bottom with distinctive ends of side walls extending from the gable wall corners. The inner space was divided by two or three partitions; on the middle axis there are distinctive post holes, whose original posts supported the roof. The characteristics mentioned above indicate that the ground plan in Drnholec "Holenická pole" is a new type which has both - the elements of long houses with a partition and trapezoid houses. A unique arrangement of houses has been encountered at the multicultural site (settlement and burial-ground) in Podivín I (six houses: Fig. 5), distr. Břeclav, and in Božice-Česká kolonie, Znojmo district. Four houses in Božice-Česká kolonie were built in pairs, other houses were located in the vicinity. This is a simple arrangement of houses next to and behind one another. Most frequently occur small densely concentrated rectangle-shaped houses from Hallstatt, La Tène and Roman periods (Horákov, Chřlice II, Opatovice II, Popice II, Brno-venkov district.; Brod n/D, Březí, Bulhary, Ivaň VI, Jevišovka II-III, Kostice, Mušov III, Nové Mlýny I-II, Pasohlávky II, Přibice IV, Stará Břeclav, Vranovice V, Břeclav district; Jaroměřice n/R, Třebíč district; Božice VI, Hrádek IV, Litobratřice I-II, Mackovice, Prosiměřice, Valtrovice, Žerotice, Znojmo district).

Burial-grounds have been found as well (Fig. 7: Znojmo-Oblekovice, Znojmo district; Rakvice, Břeclav district), mounds and graves with circular ditches and flat burial sites. A ring ditch of a large barrow has been detected (Věteřov, distr. Hodonín) and other graves with rings (Němčičky, Brno-venkov district; Cvrčovice, Nosislav, Pasohlávky, Břeclav district; Čeložnice, Hodonín district; Borotice, Božice, Mackovice, Trstěnice, Znojmo district).

Phenomena are in the region of Southern and South-western Moravia: single or double circular enclosures (roundel) dated to the Late Neolithic (Lengyel Culture, Moravian Painted Pottery) and to the Bronze Age. Marching or temporary Roman camps (Fig. 6) were found in the Southern Moravia (the lower Dyje and Svratka river basin, lower Morava river basin, e.g. Charvátská Nová Ves, Mušov, Šakvice, Břeclav district: *Kovárník 1998*) and more recently in the Central and Northern Moravia (central Morava and lower Bečva river basin: Veselíčko-Osek, Přerov district), which is very surprising. In Veselíčko-Osek, marks consist of two lines, which are 100 meters from each other. One of them makes the typical rounded corner which looks like it was "doubled". It indicates the ditch enclosure, being rather post-prehistoric. The structure is located at the entrance of the so-called Moravian Gate, heading due North-east of town Přerov (*Kovárník 2005*). Moravian Gate was a part of a trade and migration route (Amber Road) of major importance, connecting the Adriatic Sea (Mediterranean; town Aquileia) with the Baltic Sea.

In the South and in the South-western Moravia were until recently known only three circular enclosures (Bulhary, Břeclav district; Křepice Těšetice-Kyjovice, Znojmo district: *Podborský 1988*). Nevertheless, more than 15 circular enclosures were discovered until today (*Kovárník 1997; 2004; Podborský ed. 1999*). Their diameter ranges between 40 up to 240 m (*Kovárník 2004, 13-17; Kuzma 2005, 53-57; Kuzma/Tirpák 2000*). Southern and Central Moravia is the North-western borderland of the Middle Danube region, where circular enclosures of the Lengyel period are found. The author emphasizes their significance for a gradually increasing complexness of prehistoric social structures. Their function is believed to be connected with farming cults of the Neolithic and with the observation of the Sun and Moon.

In the district of Bruntál, Jeseník, Šumperk, Vsetín and Zlín, in the mountain range of Moravské Beskydy and Jeseníky a great number of medieval plough lands were recorded. Similar examples were found in the area of Českomoravská vysočina in district of Třebíč, Jihlava and Žďár n/S as well. On slopes occurs characteristic layout of plough lands of original wood tract villages from the Middle Ages.

Documentation of old, probably medieval roads (from the town Hrotovice to the deserted medieval village Mstěnice, Třebíč district; from Hustopeče to Strachotín, Břeclav district; from Jevišovice to Slatina, Znojmo district etc.) as well as of town centres (Znojmo, Moravský Krumlov, Třebíč) or castles, monasteries and churches is questioning.

The author applies the combination of aerial and geophysical survey in the field survey. Magnetometry is the main geophysical method used here (by using caesium magnetometer). Geophysical measurements were applied for verification of foundations of the Late Neolithic circular enclosures in Rašovice, Vyškov district, Vedrovice, Znojmo district, of elliptic enclosures (oval-shaped ditches - rondeloids) in Troskotovice, Znojmo district, from the Bronze Age (Hašek/Kovárník 1999) and of other structures (Znojmo-Hradiště) etc. (Hašek/Kovárník 1996).

REFERENCES

- Braasch/Christlein 1982* O. Braasch/R. Christlein: Das unterirdische Bayern. 7000 Jahre Geschichte und Archäologie im Luftbild, Stuttgart 1982.
- Hašek/Kovárník 1996* V. Hašek/J. Kovárník: Geofyzika v moravské středověké archeologii. Muzejní a vlastivědná práce, Časopis společnosti přátel starožitností 34, 1996, 65-88.
- Hašek/Kovárník 1997* V. Hašek/J. Kovárník: Letecká a geofyzikální prospekce při výzkumu pravěkých kruhových příkopů na Moravě, Sborník prací Filozofické fakulty brněnské Univerzity M 1, 1996, 57-79.
- Hašek/Kovárník 1999* V. Hašek/J. Kovárník: Aerial and Geophysical Prospection in Archaeological Research of Prehistoric Circular Ditches in Moravia, Archaeological Prospection 6, 1999, 187-209.
- Kovárník.1985* J. Kovárník: Dosavadní výsledky leteckého archeologického průzkumu na jižní Moravě, Přehled výzkumů Archeologického ústavu v Brně (1983), 1985, 102-105.
- Kovárník 1986* J. Kovárník: Zur Frage der Verbreitung der Kreisgräben in der Kultur mit mährischer bemalter Keramik im Kreise Znojmo. In: B. Chropovský/H. Friesinger (eds.), II. Internationales Symposium über die Lengyel-Kultur. Nitra - Wien 1986, 151-161.
- Kovárník 1997* J. Kovárník: K významu pravěkých kruhových příkopů. Úvahy k hospodářství, náboženství a organizovanosti starých zemědělských civilizací, Brno 1997.
- Kovárník 1998* J. Kovárník: Neue Entdeckungen römischer Feldlager nördlich von der Mittdonau. In: J. Čížmářová/Z. Měchurová (eds.), Peregrinatio Gothica, Supplementum ad Acta Musei Moraviae, Scientiae sociales LXXXII, 1997, 87-109.
- Kovárník 2004* J. Kovárník: Nově zjištěná pravěká příkopová ohrazení na Moravě. Rondely, rondeloidy a jiné příkopy - stručné shrnutí problematiky. In: V. Hašek/R. Nekuda/M. Ruttkey (eds.), Ve službách archeologie V., Brno 2004, 11-38.
- Kovárník 2005* J. Kovárník: Nový nález porostových příznaků příkopu u Lipníku n/B - Předběžná zpráva. In: V. Hašek/R. Nekuda/M. Ruttkey (eds.), Ve službách archeologie VI., Brno 2005, 43-48.
- Kuzma 2005* I. Kuzma: Letecká archeológia na Slovensku. In: V. Hašek/R. Nekuda/M. Ruttkey (eds.), Ve službách archeologie VI., Brno 2005, 49-64.
- Kuzma/Tirpák 2001* I. Kuzma/J. Tirpák: Rondel v Golianove, okr. Nitra (predbežná správa) - Die Kreisgrabenanlage in Golianovo, Bez. Nitra (Vorbericht), in: M. Metlička (ed.), Otázky neolitu a eneolitu našich zemí - 2000, Plzeň 2001, 46-55.
- Podborský 1988* V. Podborský: Těšetice-Kyjovice 4. Rondel osady lidu s moravskou malovanou keramikou, Brno 1988.
- Podborský 1999* V. Podborský (ed.), Pravěká sociokultovní architektura na Moravě. Brno 1999.
- Podborský/Kovárník 2006* V. Podborský/J. Kovárník: Neolithic and post-Neolithic enclosures in Moravia in their central European context. In: A. Harding/S. Sievers/N. Venclová (eds.), Enclosing the Past: inside and outside in prehistory, Sheffield Archaeological Monographs 15, Sheffield 2006, 44-68.

Jaromír Kovárník
 Jihomoravské muzeum
 Přemyslovců 8
 669 45 Znojmo, Czech Republic
 kovarnik@znojmuz.cz

**AIR SURVEY AND REMOTE-SENSED DATA ANALYSIS IN BOHEMIA (CZ).
A JOINT PROJECTS OF THE INSTITUTE OF ARCHAEOLOGY,
PRAGUE AND UNIVERSITY OF WEST BOHEMIA, PLZEŇ**

Martin Gojda

Key words: Bohemia, air survey, remote sensing

During the last few years aerial archaeology in Bohemia has been developing especially due to financial support allocated by the ministry of education to the Department of Archaeology of the University of West Bohemia. Due to an agreement between the Department and Prague Institute of Archaeology (Czech Academy of Sciences), which since 1997 owns a small aircraft Cessna 172, more than 50 flying hours have been annually flown over the country during which many new sites and features were identified, recorded and photographed. Special attention has been given to the territory around the sacred hill of Říp situated north of Prague in which a long-term project focused on non-destructive survey (aerial prospection, fieldwalking and surface collection, geophysical measurement and test diggs) and palaeoenvironmental study has been launched in 2006. The paper will inform about current achievements within this project including results of digital aerial and satellite ortophotos analysis both on the Říp territory and in surrounding regions.

Martin Gojda

University of West Bohemia
Department of Archaeology
Sedláčkova 15
306 14 Plzeň, Czech Republic
gojda@kar.zcu.cz

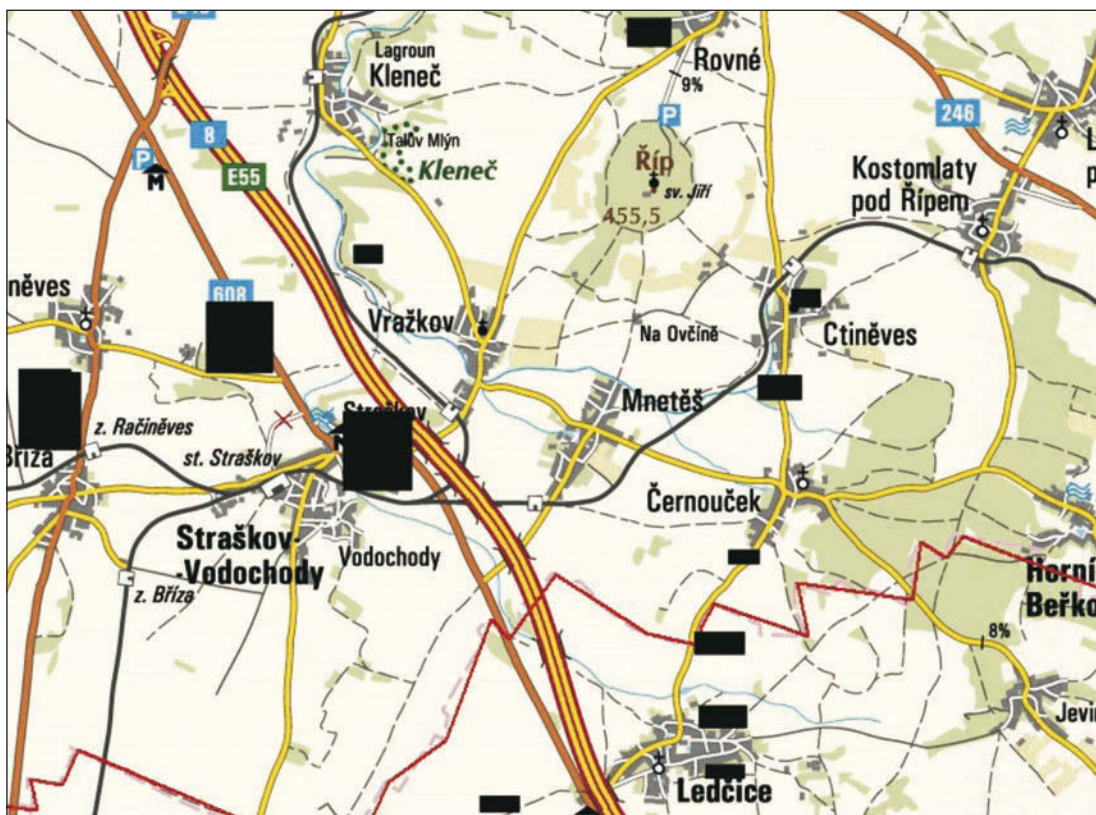

Fig. 1. Map of the central Říp territory with areas of archaeological sites identified by cropmarks as indicated by black quadrangles (their size corresponds to the size of area with cropmarks).

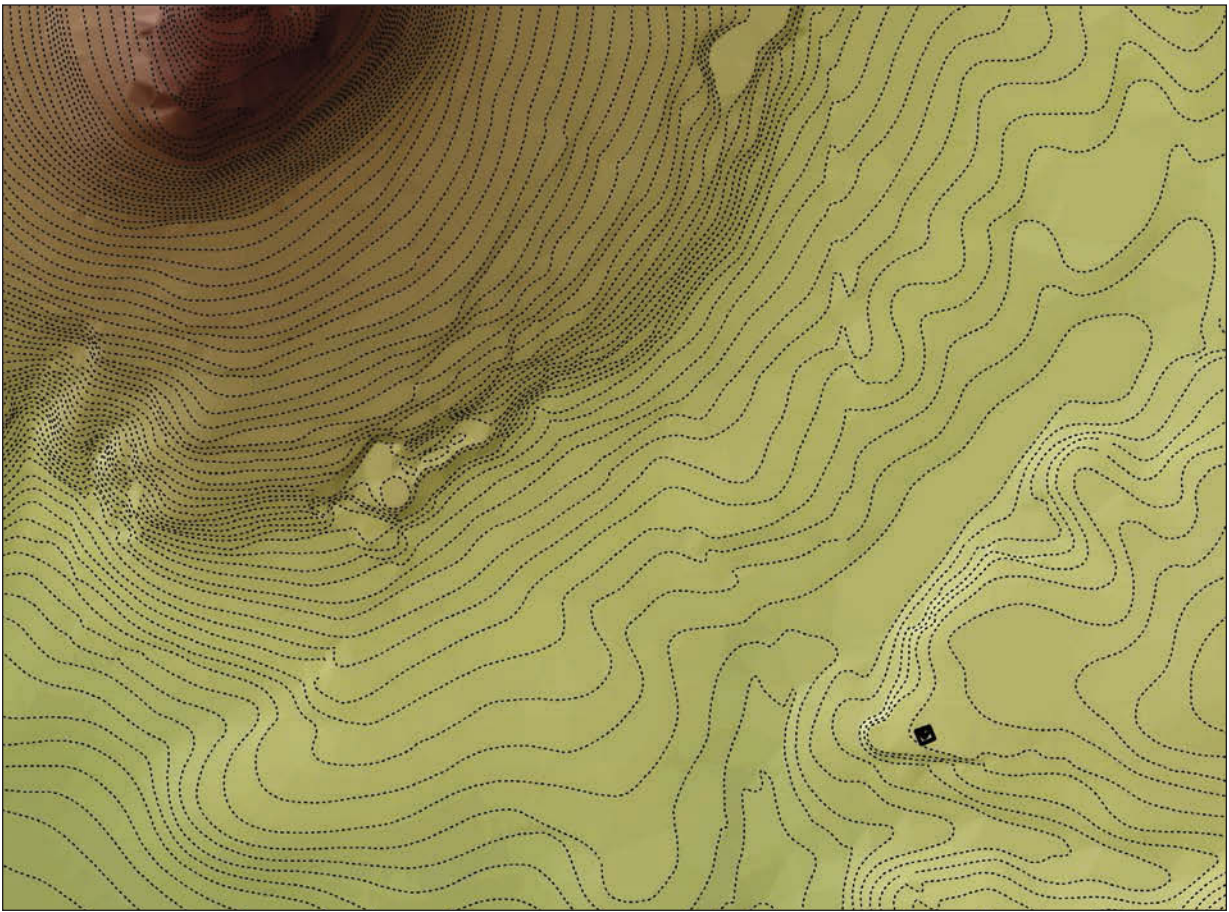

Fig. 2. DEM of the area SE of the hill of Říp with the setting of a rectangular double enclosure - a structure which with most probability of funereal origine identified recently from the air.

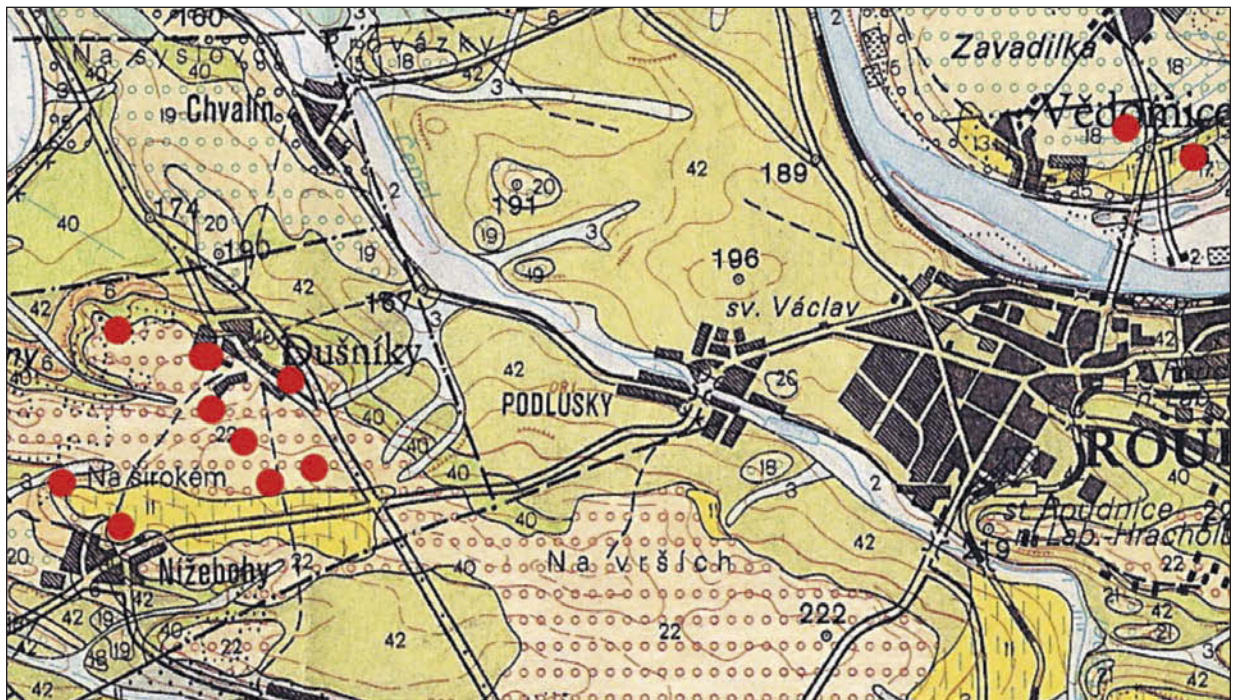
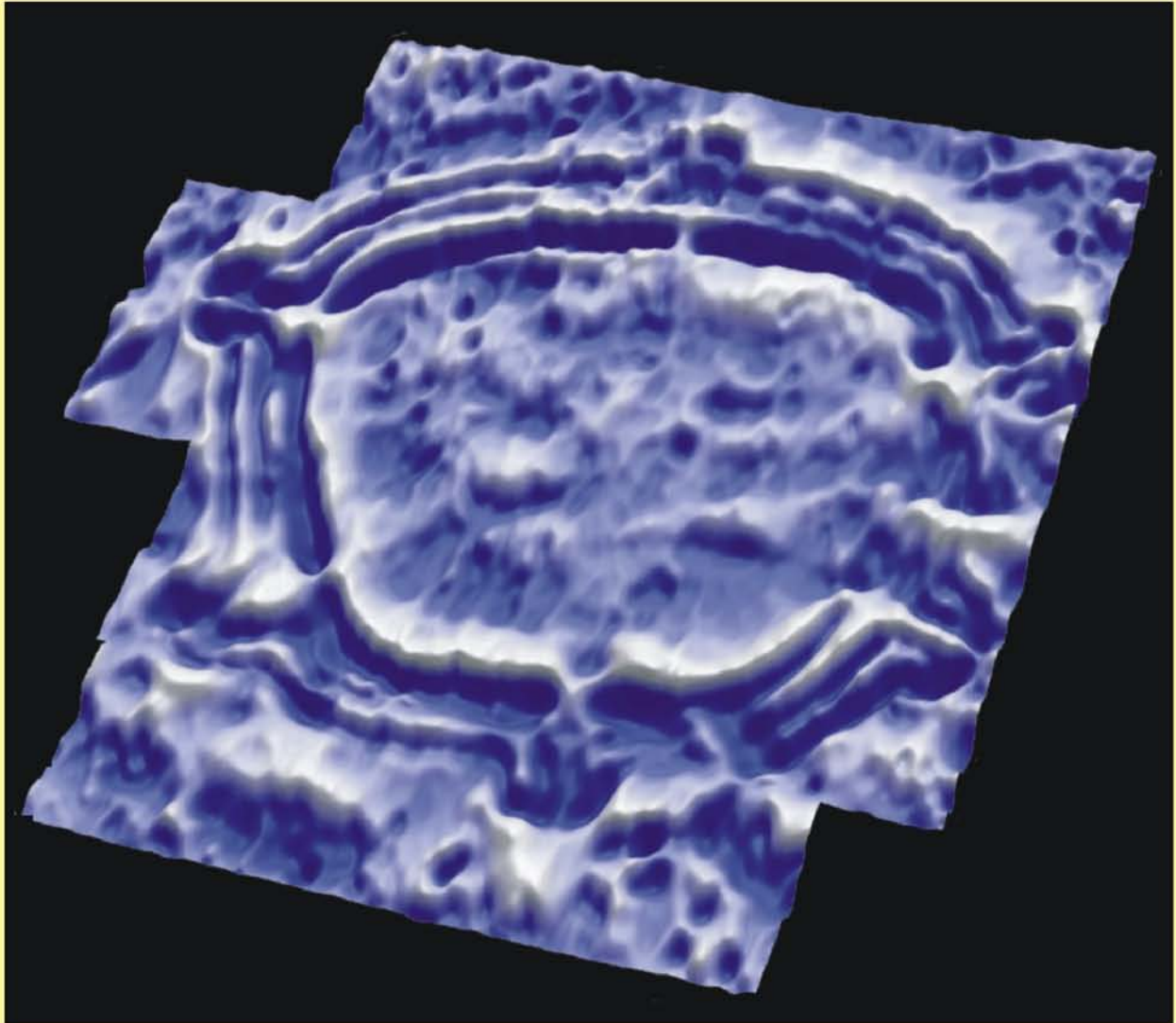

Fig. 3. Map of sub-soil substrates of the area north-west of the Říp with recently evicenced cropmark sites (red circles). They are almost completely spread over sand/gravel substrate (lines of small circles).



ISSN 0560-2793

ISBN 978-80-89315-00-0



9 788089 315000